

SALTO XS4 \ PRICELIST

SALTO Systems' unique networked wire-free escutcheons and electronic cylinders can be used for an extensive range of access control applications. It's the first data-on-card RFID system that can be upgraded at any time..

Welcome to the access, Welcome to SALTO Systems.

www.saltosystems.com

International Price List

Valid as from July 2020



**MIFARE
DESFire**



LEGIC
advant innovation in ID technology

picopass®



Index

SALTO XS4 ONE Electronic escutcheons.....	7	Model Ex6P8xK.....	117
Model Ex750.....	11	ANSI wide body escutcheon	119
Model Ex751.....	12	Model Ax650	119
Model Ex752.....	13	Model Ax656	121
Model Ex753.....	14	Model Ax658	123
Model Ex754.....	15	Model Ax660	125
Model Ex756.....	16	Model Ax666	127
Model Ex757.....	17	Model Ax668	129
Model Ex7P0	18	ANSI wide body escutcheon with keypad.....	131
Model Ex7P1	19	Model Ax650xK.....	131
Model Ex7P6	20	Model Ax656xK.....	133
XS4 One European DIN body escutcheon	21	Model Ax658xK.....	135
Model Ex750 DIN	21	Model Ax660xK.....	137
Model Ex756 DIN	22	Model Ax666xK.....	139
Model Ex7P0 DIN	23	Model Ax668xK.....	141
Model Ex7P6 DIN	24	Scandinavian narrow body escutcheon.....	143
XS4 ONE Complementary escutcheons.....	25	Model Sx450.....	143
Model E0700.....	25	Model Sx451.....	145
Model E0701.....	25	Model Sx454.....	147
Model E07C1	26	Model Sx455.....	149
Model E0702.....	26	Model Sx456.....	151
Model E0703.....	27	Model Sx457.....	153
Model E0704.....	27	Scandinavian wide body escutcheon.....	155
Model E0709.....	28	Model Sx650.....	155
Escutcheon finishes	29	Model Sx651.....	157
Escutcheon handles	30	Model Sx654.....	159
SALTO Electronic escutcheons.....	31	Model Sx655.....	161
European narrow body escutcheon	35	Model Sx656.....	163
Model Ex450.....	35	Model Sx657.....	165
Model Ex451.....	37	Scandinavian wide body escutcheon with keypad ..	167
Model Ex452.....	39	Model Sx650xK	167
Model Ex453.....	41	Model Sx651xK.....	169
Model Ex454.....	43	Model Sx654xK	171
Model Ex456.....	45	Model Sx655xK.....	173
Model Ex457.....	47	Model Sx656xK.....	175
Model Ex4P0	49	Model Sx657xK.....	177
Model Ex4P1	51	European complementary range	179
Model Ex4P6	53	Model E0400.....	179
Model Ex4K0	55	Model E0401.....	179
Model Ex4K2	57	Model E04C1	180
Model Ex4K3	59	Model E0402.....	180
Model Ex4K4	61	Model E0403.....	181
European DIN body escutcheon	63	Model E0404.....	181
Model Ex550.....	63	Model E0409.....	182
Model Ex556.....	65	Model E0600.....	182
Model Ex5P0	67	Model E0601.....	183
Model Ex5P6	69	Model E06C1	183
European wide body escutcheon	71	Model E0602.....	184
Model Ex650.....	71	Model E0603.....	184
Model Ex651.....	73	Model E0604.....	185
Model Ex652.....	75	Model E0609.....	185
Model Ex653.....	77	ANSI complementary range	186
Model Ex654.....	79	Model A0600	186
Model Ex656.....	81	Model A0608	186
Model Ex657.....	83	Scandinavian complementary range.....	187
Model Ex658.....	85	Model S0400.....	187
Model Ex6P0	87	Model S0401.....	187
Model Ex6P1	89	Model S0404.....	188
Model Ex6P6	91	Model S0405.....	188
Model Ex6P8	93	Model S0600.....	189
European wide body escutcheon with keypad.....	95	Model S0601.....	189
Model Ex650xK.....	95	Model S0604.....	190
Model Ex651xK.....	97	Model S0605.....	190
Model Ex652xK.....	99	Escutcheon finishes	191
Model Ex653xK.....	101	Escutcheon handles	192
Model Ex654xK.....	103	SALTO XS4MINI	193
Model Ex656xK.....	105	XS4 Mini European escutcheon.....	193
Model Ex657xK.....	107	Model Ex150.....	196
Model Ex658xK.....	109	XS4 Mini Accessories	199
Model Ex6P0xK.....	111	Model SP221457	199
Model Ex6P1xK.....	113	Model LE8P12	199
Model Ex6P6xK.....	115	Model HT	199

Index

Model PH	200	Model GxE2K	314
Model PZ	200	Model GxE3x	316
Model TE010	201	Model GxE9x	318
Cover Plate 059 (DIN 72)	202	Model GxCLx	320
Cover Plate 059 (PZ 85)	202	Model GxU1x	322
Cover Plate Mini custom	203	Model GxU2x	324
XS4 Mini Australian escutcheon	204	Model GxU3x	326
Model Ux150	207	Model GxH1x	328
XS4 Mini Scandinavian Escutcheon	210	Model GxH2x	330
Model Sx150	213	Model GxH2xK	332
Model Sx151	214	Model GxH3x	334
Model Sx154	215	Model GxS1x	336
Model Sx160	216	Model GxS2x	338
Model Sx161	217	Model GxS3x	340
Model Sx170	218	Model GxK1x	342
Model Sx171	219	Model GxB1x	344
Model SP221457	222	Model GxB2x	346
Model PPD800	222	Model GxB3x51	348
XS4 Mini Finnish Escutcheon	223	Model GxB3x41	350
Model Fx150	226	Model GxM1x	352
Model Fx151	227	Model GxA1x	354
Model Fx154	228	Model GxP2x	356
Model Fx160	229	SALTO GEO cylinder Finishes	357
Model Fx161	230	SALTO GEO Electronic cylinder Accesories	358
Model Fx170	231	Model SP301585	358
Model Fx171	232	Model SP301582	358
XS4 Mini ANSI	235	Model SP220764	358
Model Cx250	238	SALTO Geo Grip A	358
Model Cx260	239	SALTO Geo Grip H	358
XS4 Mini ANSI Finishes	240	Model SP201587	359
Cover Plate COPLEMA090	241	Ælement Fusion the design RFID electronic lock 360	
Cover Plate Mini ANSI custom	241	Ælement Fusion Electronics	
SALTO NEO cylinder	242	(Reader and control module)	361
Model NxE1x	246	Model AFx	363
Model NxE1xA	248	Ælement Fusion Mortise locks	364
Model NxE2x	250	Model LE7S07	366
Model NxE2xA	252	Model LE7S17	366
Model NxE2xK	254	Model LA1T17	367
Model NxE3x	256	Model LA1T07	367
Model NxE9x	258	Ælement Fusion Accessories	368
Model NxCLx	260	Model TE010	368
Model NxU1x	262	Model HT	369
Model NxU2x	264	Model PH	369
Model NxU3x	266	Model PZ	370
Model NxH1x	268	Ælement the design RFID electronic lock	371
Model NxH2x	270	Ælement Electronics	
Model NxH2xK	272	(Reader and control module)	372
Model NxH3x	274	Model AE90	374
Model NxS1x	276	Model AE91	374
Model NxS2x	278	Ælement Electronic finishes	375
Model NxS3x	280	Ælement Mortise locks	376
Model NxK1x	282	Model LE7S07	378
Model NxB1x	284	Model LE7S17	378
Model NxB2x	286	Model LE7E37	379
Model NxB3x51	288	Model LA1T17	379
Model NxB3x41	290	Model LA1T07	380
Model NxB4x	292	Ælement Accessories	381
Model NxM1x	294	Model TE010	381
Model NxA1x	296	Model HT	382
Model NxJ1x	298	Model PH	382
Model NxJ1x	299	Model PZ	383
SALTO NEO cylinder Finishes	300	Ælement Handles	384
SALTO NEO Electronic cylinder Accesories	301	Model U	385
Model SP225542	301	Model E	386
Model SP01926-5	301	Model G	387
Model SP201587	301	Model J	387
Model SP301585	301	Model L	388
SALTO GEO cylinder	302	Model O	389
Model GxE1x	306	Model S	390
Model GxE1xA	308	Model T	390
Model GxE2x	310	Model K	391
Model GxE2A	312		

Index

Model W.....	392	Model LE7A.....	447
Model N.....	393	Model LE7A00 for passive leaf.....	447
Model Z.....	393	Model PBF110.....	448
Ælement COLOMBO handles.....	394	Advanced panic bar solutions - Kit panic bars.....	449
Model 2 (Robodue).....	394	KPB01.....	449
Model 3 (Robotre).....	394	KPB02.....	450
Model 4.....	395	KPB03.....	451
(Roboquattro).....	395	KPB04.....	452
Model 5 (Elle).....	395	KPB05.....	453
Model Mach.....	396	KPB06.....	454
Ælement SALTO handles accessories.....	397	KPB07.....	455
Screws bag.....	397	KPB08.....	456
Ælement Roses accessories.....	398	KPB10.....	457
Model PH.....	399	KPB11.....	458
Model PZ.....	399	KPB12.....	459
Model WC.....	400	KPB13.....	460
Model PX.....	400	KPB14.....	461
Double reader models.....	401	KPB15.....	462
Model ExCD0.....	403	KPB16.....	463
Double reader European models.....	403	KPB17.....	464
Model ExCD2.....	404	KPB18.....	465
Model ExCD4.....	405	KPB19.....	466
Double reader Scandinavian models.....	406	KPB20.....	467
Model SxCD0.....	406	KPB21.....	468
Model SxCD4.....	407	KPB22.....	469
Double reader escutcheon finishes.....	408	KPB23.....	470
Double reader escutcheon handles.....	409	KPB24.....	471
DIN Glass door lock model.....	410	KPB25.....	472
Model Ex650xGD.....	412	KPB26.....	473
Model Ex654xGD.....	413	KPB27.....	474
Model Ex6P0xGD.....	414	KPB28.....	475
Complementary DIN glass door lock model.....	415	KPB29.....	476
Model E0600xGD.....	415	KPB30.....	477
Model E0602xGD.....	415	KPB31.....	478
Model E0603xGD.....	416	KPB32.....	479
Model E0604xGD.....	416	KPB33.....	480
Model E0609xGD.....	417	KPB34.....	481
Glass door lock model DIN counter strike.....	417	KPB35.....	482
Glass door lock model DIN handles.....	418	KPB36.....	483
Advanced Panic bar solutions.....	419	KPB37.....	484
Advanced panic bar solutions - half escutcheons... 422		KPB39.....	485
Model Ex450xH.....	422	KPB40.....	486
Model Ex454xH.....	423	KPB41.....	487
Model Ex4P0xH.....	424	KPB42.....	488
Model Ex650xH.....	425	KPB43.....	489
Model Ex654xH.....	426	KPB44.....	490
Model Ex660xH.....	427	KPB45.....	491
Model Ex650xHxK.....	428	KPB46.....	492
Model Ex654xHxK.....	429	KPB47.....	493
Model ExP0xHxK.....	430	KPB48.....	494
Model Ex750xD.....	431	KPB49.....	495
Model Ex754xD.....	432	KPB50.....	496
Model Ex7P0xD.....	433	KPB51.....	497
Model Ax650xH.....	434	KPB52.....	498
Model Ax660xH.....	435	KPB53.....	499
Model Ax650xHxK.....	436	KPB54.....	500
Model Ax660xHxK.....	437	KPB55.....	501
Model Sx450xH.....	438	KPB56.....	502
Model Sx454xH.....	439	Wireless.....	504
Model Sx650xH.....	440	Model Gateway SALTO BLUEnet.....	504
Model Sx654xH.....	441	Model SALTO BLUEnet node.....	504
Model Sx650xHxK.....	442	Model SALTO BLUEnet repeater.....	504
Model Sx654xHxK.....	443	Model BLUEnet inRoomNode.....	505
Advanced panic bar solutions finishes.....	444	Model Gateway.....	505
Advanced panic bar solutions escutcheon handles 445		Model Gateway for Wireless RFnet.....	505
Advanced panic bar solutions - Panic bars.....	446	Model RF node.....	506
Model PBE900.....	446	antenna.....	506
Model LE7E.....	446	Door detector.....	506
Model LE9E.....	446	Model Wireless.....	506
Model PBA120.....	447	Cover-all plates for SALTO XS4 models.....	507
		Cover Plate 045.....	507
		Cover Plate 052.....	507
		Cover Plate 055.....	508
		Cover Plate 065.....	508

Index

Cover Plate 075.....	508	Model CE8P0C00.....	535
Cover Plate 085.....	509	Model CE8P0R00.....	535
Cover Plate 095.....	509	Model CE8P1CSx.....	536
Cover Plate 110.....	509	Model CE8P1RSx.....	536
Cover Plate 075KN.....	510	Model CE8P0CSx.....	536
Cover Plate 055.....	510	Model CE8P0RSx.....	536
Cover Plate 090.....	510	Model CE8P1CLx.....	537
Cover Plate 180S.....	511	Model CE8P1RLx.....	537
Cover Plate 180R.....	511	Model CE8P1AL2.....	537
Cover Plate 200S.....	511	Model CE8P1CE0.....	537
Double Reader.....	512	Model LE7W31.....	538
Double Reader.....	512	Model LE9W31.....	538
Cover-all plates for SALTO XS4 One models.....	513	Model LE7E31.....	539
Cover Plate G45.....	513	Model LE9E11.....	539
Cover Plate G50.....	513	Model CE7W1CS50.....	540
Cover Plate G55.....	513	Model CE7W1RS50.....	540
Cover Plate G65.....	514	Model CE7W1CE00.....	540
Cover Plate G75.....	514	Model CE7W1RE00.....	540
Cover Plate G85.....	514	ANSI mortise locks.....	541
Cover Plate G90.....	515	Model LA1T05.....	541
Cover Plate G180S.....	515	Model LA1T15.....	541
Cover Plate G180R.....	515	Model CE1T1AL.....	542
Cover-all plates		Model CE1T1AS.....	542
for SALTO XS4 Euro models.....	516	Model.....	542
Custom cover plate Symmetrical.....	516	Custom strike plate.....	543
Custom cover plate Asymmetrical.....	516	Cylindrical latches.....	544
Custom cover-all plates		Model LC1K.....	544
for SALTO XS4 Scandinavia.....	517	Model LC2K.....	544
Custom cover plate Symmetrical.....	517	Model 01848.....	544
Custom cover plate Asymmetrical.....	517	Model CELTKA.....	545
Custom cover-all plates		Model CELTKT.....	545
for SALTO XS4 ANSI models.....	518	Model CELTKL.....	545
Custom cover plate Symmetrical.....	518	Scandinavian mortise locks.....	546
Custom cover plate Asymmetrical.....	518	Model LS5N04.....	548
Mortise locks.....	519	Model LS5N05.....	548
Strike plates.....	521	Model LS5N15.....	548
DIN compatible European mortise locks.....	522	Model LS5N25.....	549
Model LE7S05.....	522	Model.....	
Model LE7S15.....	522	CE5N1R000ZP.....	549
Model LE7S25.....	523	Wall readers.....	550
LE7S strike plates.....	524	Wall readers Picopass.....	550
Model CE7S0CSx0.....	524	Model WRM7000.....	550
Model CE7S1CSx0.....	524	Model WRM7001.....	550
Model CE7S0RSx0.....	525	Model WRM7000E.....	550
Model CE7S1RSx0.....	525	Model WRM7001E.....	551
Model CE7S0C000.....	526	Model WRM7000EK.....	551
Model CE7S1C000.....	526	Model WRM7001EK.....	551
Model CE7S0R000.....	526	Model WR7001FS.....	551
Model CE7S1R000.....	526	Wall readers Legic.....	552
Model CE7S0CLx0.....	527	Model WRM8000.....	552
Model CE7S1CLx0.....	527	Model WRM8001.....	552
Model CE7S0RLx0.....	528	Model WRM8000E.....	552
Model CE7S1RLx0.....	528	Model WRM8001E.....	552
Model CE7S0CE0.....	529	Model WRM8000EK.....	552
Model CE7S1CE0.....	529	Model WRM8001EK.....	553
Model CE7S0RE0.....	529	Model WR8001FS.....	553
Model CE7S1CE0.....	530	Wall readers Mifare DESFire.....	554
Model CE7S0CB0.....	530	Model WRM9000.....	554
Model CE7S1CB0.....	530	Model WRM9001.....	554
Model CE7S0RB0.....	531	Model WRM9000E.....	554
Model CE7S1RB0.....	531	Model WRM9001E.....	554
European mortise locks.....	532	Model WRM9000EK.....	554
Model LE8P02.....	532	Model WRM9001EK.....	555
Model LE8P12.....	532	Model WR9001FS.....	555
Model LE8P22.....	533	Wall readers HID iCLASS.....	556
Model CE8P1CS3.....	534	Model WRMH000.....	556
Model CE8P1RS3.....	534	Model WRMH001.....	556
Model CE8P0CS3.....	534	Model WRMH000E.....	556
Model CE8P0RS3.....	534	Model WRMH001E.....	556
Model CE8P1C00.....	535	Model WRMH001EK.....	557
Model CE8P1R00.....	535	Model WRH001FS.....	557
		Wall readers accessories.....	557
		Model WRMKP.....	557

Index

Model WRMBL1	557	Model WRLUD-4TT08	578
Model WRMBL2	557	WRLUD Credentials	578
Model WRMBH1	558	Control units	579
Model WRMBH2	558	Model CU5000	579
Model WRMFWAV	558	Model CU50EN	579
Model WRMFHAV	558	Model CU50ENSVN	579
Model WRMFS	558	Control units - Power supply box	580
Wall readers pedestal Picopass	559	Model PB212S	580
Model WRMPE7SN	559	Model PB212L	580
Model WRMPE7SK	559	Model EB5008	580
Model WRMPE7DN	560	Model WRADAP	580
Model WRMPE7DK	560	Control units - accessories	581
Wall readers pedestal Legic	561	Model CUADAP	581
Model WRMPE8SN	561	Model CU5EN-PCB	581
Model WRMPE8SK	561	Model CU5SVN-PCB	581
Model WRMPE8DN	562	Updaterkit UBOX	582
Model WRMPE8DK	562	UBOX 8000 Legic Advant	582
Wall readers pedestal Mifare DESFire	563	UBOX 8001 Legic Advant	582
Model WRMPE9SN	563	UBOX 9000 Mifare DESFire	582
Model WRMPE9SK	563	UBOX 9001 Mifare DESFire	582
Model WRMPE9DN	564	UBOX H000 HID ICLASS	583
Model WRMPE9DK	564	Updater kit UBOX	583
Wall readers pedestal HID iCLASS	565	Management tools	584
Model WRMPEHSN	565	Picopass Management tools	584
Model WRMPEHSK	565	Model EPS100	584
Model WRMPEHDN	566	Model PPD800	584
Model WRMPEHDK	566	SP226093	584
SALTO Controller and Reader	567	Picopass Management tools	585
SALTO Readers - MIFARE DESFire	567	Model EC7000	585
Model WRDB0x4x	567	Model EC70USB	585
Model WRDB0x4xK	567	Model EC70EN	585
Model WRDB0A4x	567	Model EC70DR	585
Model WRDB0A4xK	568	Legic Management tools	586
Model WRMB004x	568	Model PPD800	586
Model WRDB0M4x	568	Model EC8000	586
Model WRDB0P40	568	Model EC80USB	586
SALTO Readers - LEGIC ADVANT	569	Model EC80EN	586
Model WRDG0x4xK	569	Model EC80DR	586
Model WRDG0A4xK	569	Mifare DESFire Management tools	587
SALTO Readers - HID iCLASS	570	Model PPD800	587
Model WRDJ0x4	570	Model ECB04B0	587
Model WRDJ0x4xK	570	Model EC9000	587
Model WRDJ0Ax	570	Model EC90USB	587
Model WRDJ0AxK	570	Model EC90EN	588
Model WRMJ004x	571	Model EC90DR	588
Model WRDJ0M4x	571	HID iCLASS Management tools	589
Model WRDJ0P40	571	Model PPD800	589
SALTO Readers - accessories	571	Model ECJ04B0	589
Model WRMBL1x	571	Model ECH000	589
Model WRMFWAV	572	Model ECH0USB	589
Model WRMBH1x	572	Model ECH0EN	590
Model WRMFHAV	572	Model ECH0DR	590
Model WRMFS	572	SALTO Locker locks	591
XS4 Controllers	573	XS4 Locker	591
Model CU42E0x	573	Model Lx050x	592
Model CU42E0	573	XS4 Locker distance plates	592
Model CU4200x	573	XS4 Locker distance plates	592
Model CU4200	573	Bolt enlarger	592
Model SPCU4BOXx	574	Energy saving devices	593
Model SP224861	574	Model ESD9000	593
Model SP224895	574	Model ESD9000 online	593
Model CU4EB8	574	SALTO Software	594
Model CU4EB8x	575	SALTO ProAccess SPACE Software	594
XS4 Long distance reader	576	SALTO ProAccess & HAMS Softwares	600
Model WRLUD1	576	SALTO Carriers	603
Model WRLUD2	576	SALTO Carriers Legic	603
Model WRLUD-SIC1	576	Model ECADVANT	603
Model WRLUD-C10	577	SALTO Carriers Mifare - DESFire	604
Model WRLUD-4PC	577	SALTO Carriers HID i-CLASS	607
Model WRLUD-MB4	577	Terms and conditions	607
Model WRLUD-SNG3	577		
Model WRLUD-PS24	578		
Model WRLUD-POC08	578		



SALTO escutcheon reference example

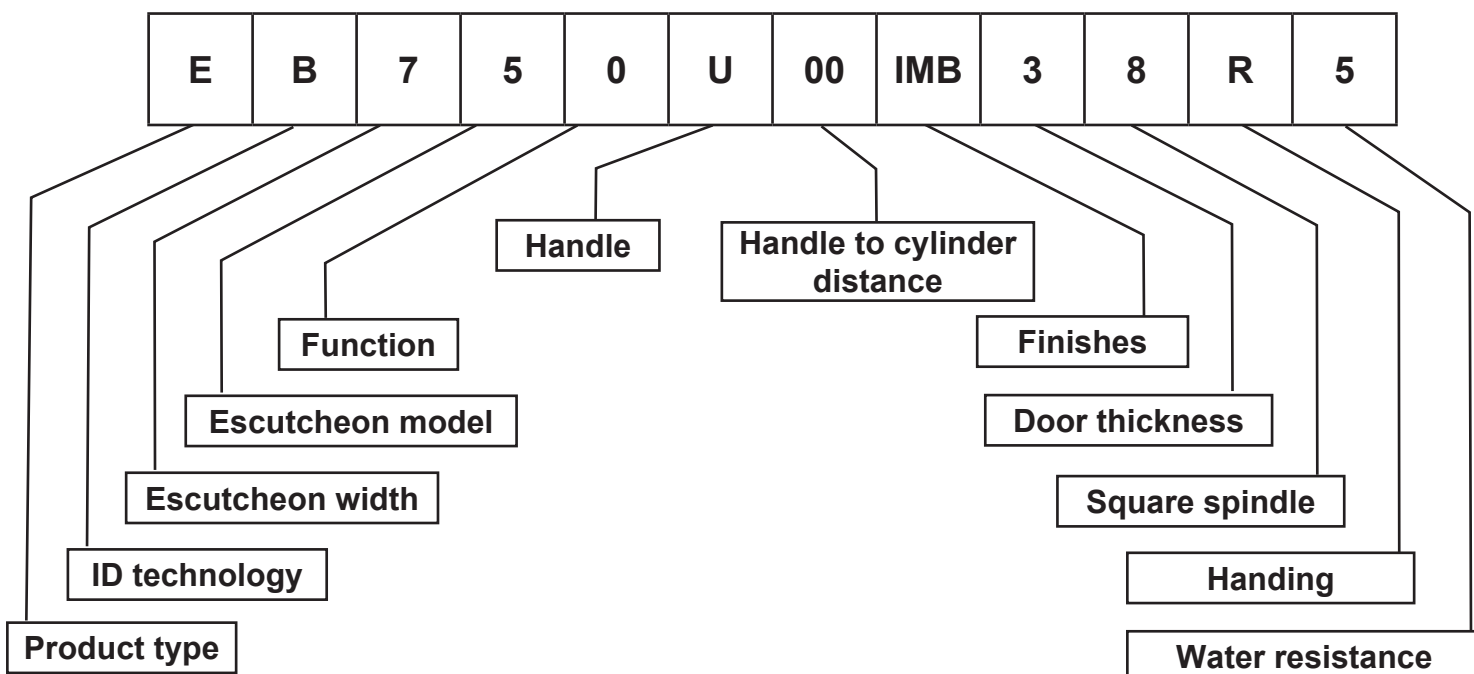

Product type:

E = European escutcheons compatible with European mortise locks.

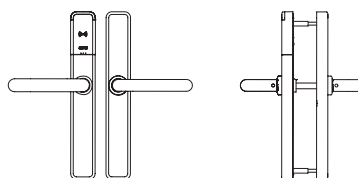

European escutcheons

ID technology

RFID

- 9 = Contactless Mifare DESFire
- B = Contactless BLE Mifare DESFire
- J = Contactless BLEHID iCLASS

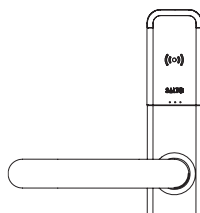

Handle set width:

7 = 42 mm

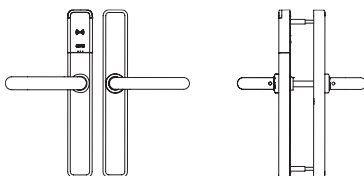

Escutcheon model:

- 5 = Clutch
- P = Clutch + Euro profile cylinder override

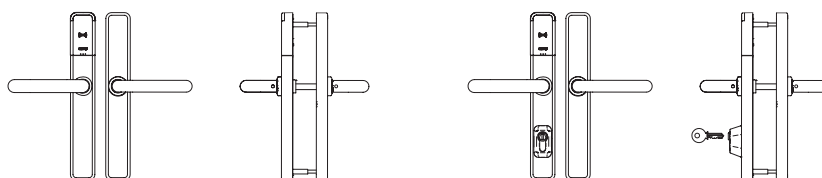

Clutch mechanism

Clutch mechanism mechanical override P

 Clutch + mechanical override P means: Euro profile cylinder mechanical override for European narrow body escutcheons.
(Euro profile mechanical cylinder 30-10 not included, for technical specifications consult SALTO).

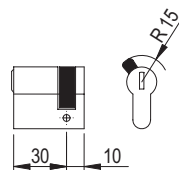

Handles

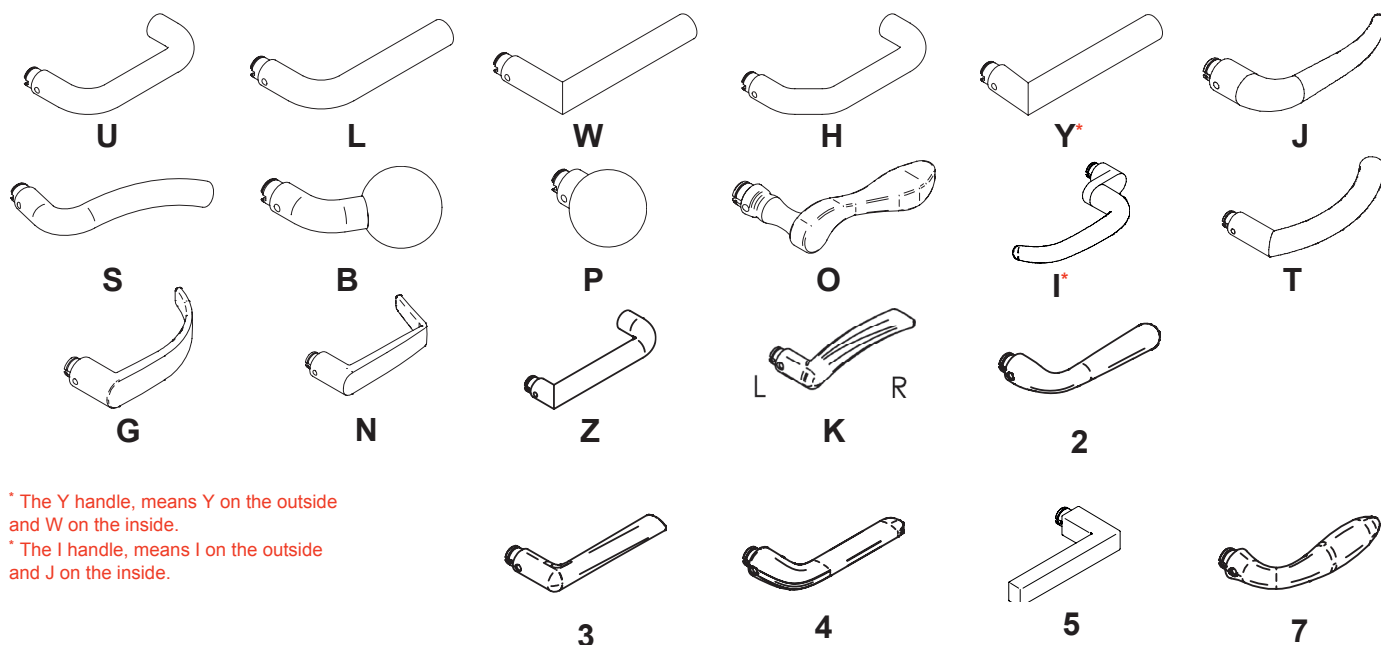

* The Y handle, means Y on the outside and W on the inside.

* The I handle, means I on the outside and J on the inside.

Distance to cylinder

- 00 = without distance
- 47 = 47mm euro profile cylinder
- 48 = 48mm euro profile cylinder
- 49 = 49mm euro profile cylinder
- 55 = 55mm euro profile cylinder
- 62 = 62mm euro profile cylinder
- 70 = 70mm euro profile cylinder
- 72 = 72mm euro profile cylinder
- 7F = 72mm for fire doors
- 78 = 78mm euro profile cylinder

- 3R = 73,5mm swiss profile cylinder
- 4R = 74mm swiss profile cylinder
- 7R = 78mm swiss profile cylinder
- 85 = 85mm euro profile cylinder
- 88 = 88mm euro profile cylinder
- 90 = 90mm euro profile cylinder
- 92 = 92 mm euro profile cylinder
- 9R = 94mm swiss profile cylinder
- 10 = 100mm euro profile cylinder
- 11 = 110mm euro profile cylinder



Fire doors
mortise locks

RO = DIN escutcheon Rose plate configuration
SH = DIN escutcheon Short plate configuration

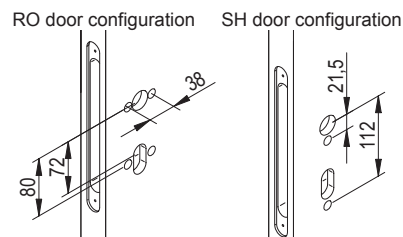

DL = For deadlatches

Finishes

IMW = Satin stainless steel and white reader
IMB = Satin stainless steel and black reader

IPW = Bright stainless steel and white reader
IPB = Bright stainless steel and black reader

PPW = Bright Brass (PVD) and white reader
PPB = Bright Brass (PVD) and black reader

PMW = Satin Brass (PVD) and white reader
PMB = Satin Brass (PVD) and black reader

IAW = Antique Brass and white reader
IAB = Antique Brass and black reader

NEW = Black and white reader
NEB = Black and black reader

BCW = BioCote - antimicrobial finish and white reader
BCB = BioCote - antimicrobial finish and black reader



IMW

Satin stainless steel
and white reader



IMB

Satin stainless steel
and black reader



IPW

Bright stainless steel
and white reader



IPB

Bright stainless steel
and black reader



PPW

Bright Brass (PVD)
and white reader



PPB

Bright Brass (PVD)
and black reader



PMW

Satin Brass (PVD)
and white reader



PMB

Satin Brass (PVD)
and black reader



IAW

Antique Brass
and white reader



IAB

Antique Brass
and black reader



NEW

Black
and white reader



NEB

Black
and black reader



BCW
BioCote

antimicrobial finish
and white reader



BCB
BioCote

antimicrobial finish
and black reader



The BioCote and IA finish is 'painted' and sharp objects such as rings and other metallic objects as well as harsh and abrasive chemicals should be avoided during any cleaning process.

Door thickness

- 3 = 32-47mm.
- 4 = 45-60mm.
- 6 = 60-75mm.
- 7 = 75-90mm.
- 9 = 90-105mm.
- 1 = 105-120mm.

! For 7,6 spindle check chart below.
The door thickness must be defined by the distance Fo (distance from the edge of the door to the HUB).

*** Note** if you have a cover plate you will need to add 1.5mm to Fo.

Door thickness 7,6 split spindle	F	P Door Thickness (Orientative)
2	14.5 mm	32 - 53 mm
A	17 mm	
B	19.5 mm	
5	22 mm	
9	16 - 58.5 mm	50 - 90 mm
1	30 - 88.5 mm	90 - 120 mm

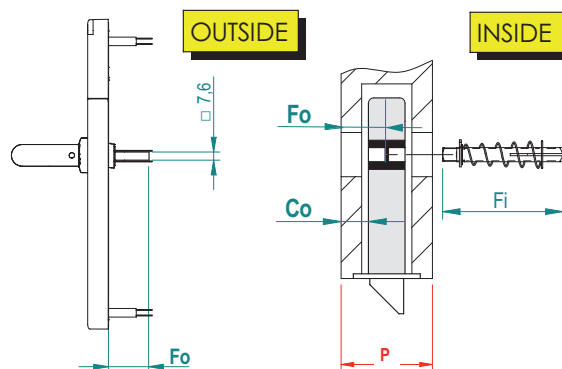
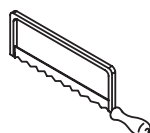

! For Deadlatch models.

Spilt spindle \square 7mm (9/32")		
t	F	Door
4	15mm (19/32")	44,5 - 51mm (1-3/4" - 2")
5	20mm (25/32")	57 - 63,5mm (2-1/4" - 2-1/2")
7	26mm (1-1/64")	70 - 76mm (2-3/4" - 3")
8	31mm (1-7/32")	82,5mm (3-1/4")

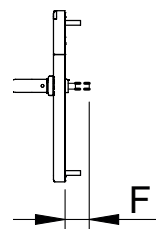

For additional information please refer to the document 4SP0010

Handle handing

R = Right hand.
L = Left hand.
just for O, K and S handles

R	RIGHT HAND
L	LEFT HAND

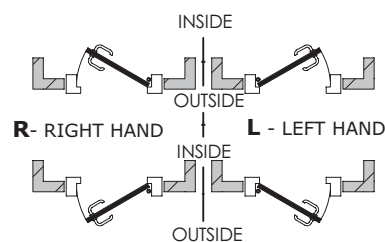

Water Resistance

- For indoor use, rating IP53
- 5 = Rating IP55 (external escutcheon, internal escutcheon IP53)

Certification

- No specific certification.
- P = PAS24 certification (Hardware may different to the standard XS4 One - Please consult SALTO for further details)

Model Ex750	SALTO XS4 ONE Electronic Escutcheon Ex750, 2 Handles, any type.
--------------------	---

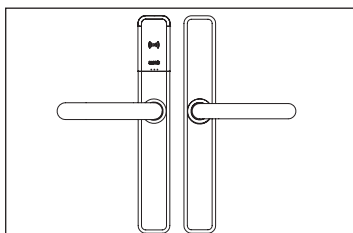

Mifare DESFire BLE
Mifare DESFire
HID iCLASS BLE

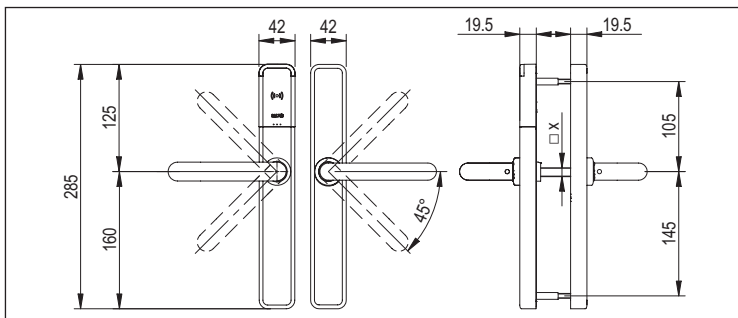

Prices - Gross prices		€
	BLE Mifare DESFire: Standard - standard square spindles, finishes and handles.	505,90
	BLE Mifare DESFire: Standard - 9mm square spindle, finishes and handles.	535,55
	Mifare DESFire: Standard - standard square spindles, finishes and handles.	477,45
	Mifare DESFire: Standard - 9mm square spindle, finishes and handles.	507,05
	BLE HID iCLASS: Standard - standard square spindles, finishes and handles.	647,55
	BLE HID iCLASS: Standard - 9mm square spindle, finishes and handles.	685,45

Technology	Escutcheon width	Function	Handle	Handle to thumbturn	Finish	Reader colour	Door thickness	Square spindle	Handing	Water resistance	Certification	
E9 Prox. Mifare DESFire	7	50	U	00 without distance	IM	B Black reader	2 F = 14,5mm	7 7 mm	-	IP53	-	
			L						-			
			W						-			
			H ²						-			
			I ²						-			
			Y ²						-			
EB Prox. BLE Mifare DESFire			S ^{1,2}	7F 72mm for fire doors	B ²	PM	W White reader	4 45-60mm	8 8 mm	R/L ¹	5 ³ IP55	P ⁴ PAS24 certification
					P ²					-		
					O ¹					-		
					J					-		
					T					-		
					Z					-		
EJ Prox. BLE HID iCLASS	G	7F 72mm for fire doors	N	IA	W White reader	6 60-75mm	S 8 mm split	-	5 ³ IP55	P ⁴ PAS24 certification		
			K ¹					-				
			2 ²					-				
			3 ²					-				
			4 ²					-				
			5 ²					-				
	N	7F 72mm for fire doors	7 ²	NE ²	W White reader	7 75-90mm	V 9 mm split	R/L ¹	5 ³ IP55	P ⁴ PAS24 certification		
			9 90-105mm F = 16 - 58,5mm					-				
			1 105-120mm F = 30 - 88,5mm					-				
				BC ² BioCote			6 7,6 mm split	-				



¹ For Handed lever handles, only for S, O or K handles.

² This option has an additional price please refer to the handles or finishes chapter.

Additional Prices - Gross prices

Ref	Remarks	€
5 ³	Water resistant (IP55)	21,30
P ⁴	PAS24 certification	20,90

Model Ex751

SALTO XS4 ONE Electronic Escutcheon Ex751, 2 Handles, any type, inside thumbturn, with connector for mortise lock with micro-switch.

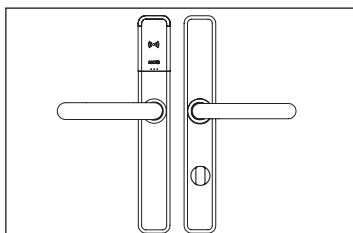

Mifare DESFire BLE
Mifare DESFire
HID iCLASS BLE

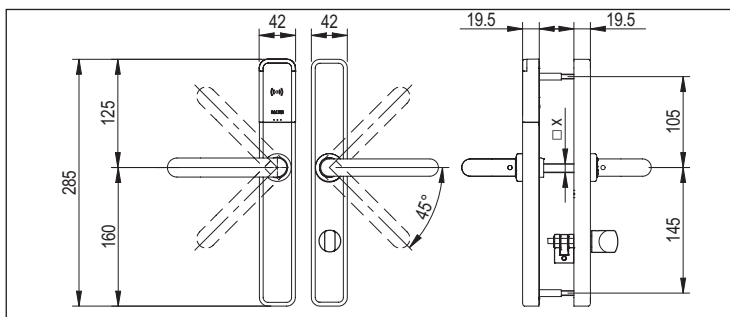

Prices - Gross prices

	€
MIFARE DESFire BLE Mifare DESFire: Standard - standard square spindles, finishes and handles.	548,55
BLE Mifare DESFire: Standard - 9mm square spindle, finishes and handles.	578,10
MIFARE DESFire Mifare DESFire: Standard - standard square spindles, finishes and handles.	520,10
Mifare DESFire: Standard - 9mm square spindle, finishes and handles.	549,65
iCLASS BLE HID iCLASS: Standard - standard square spindles, finishes and handles.	702,15
BLE HID iCLASS: Standard - 9mm square spindle, finishes and handles.	740,00

Technology	Escutcheon width	Function	Handle	Handle to thumbturn	Finish	Reader colour	Door thickness	Square spindle	Handing	Water resistance	Certification							
E9 Prox. Mifare DESFire	7	51	U	47	IM	B Black reader	3 32-47 mm	7 7mm	-	IP53	-							
			L	48					-									
			W	49					-									
			H ²	55	IP ²		4 45-60mm	-										
			I ²	62				-										
			Y ²	70				-										
S ^{1,2}			72	PP	6 60-75mm		R/L ¹											
B ²			78				-											
P ²			78				-											
EB Prox. BLE Mifare DESFire			7	51	O ¹		7F	PM	7 75-90mm			9 9mm	R/L ¹					
					J		3R						-					
					T		4R						-					
					Z		7R	-										
EJ Prox. BLE HID iCLASS					7		51	G	85			IA	W White reader	9 90-105mm	S 8mm split	-	5 ³ IP55	P ⁴ PAS24 certification
								N	88							-		
								K ¹	90							R/L ¹		
								2 ²	92			-						
								3 ²	92			-						
	4 ²	9R				-												
	5 ²	10				-												
7 ²	11	BC ² BioCote				1 105-120mm		V 9mm split	-									
									-									
									-									



¹ For Handed lever handles, only for S, O or K handles.

² This option has an additional price please refer to the handles or finishes chapter.

Additional Prices - Gross prices

Ref	Remarks	€
5 ³	Water resistant (IP55)	21,30
P ⁴	PAS24 certification	20,90

Model Ex752

SALTO XS4 ONE Electronic Escutcheon Ex752,
2 Handles, any type, Inside/Outside cylinder cut out.

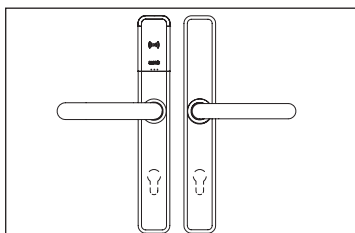

Mifare DESFire BLE
Mifare DESFire
HID iCLASS BLE

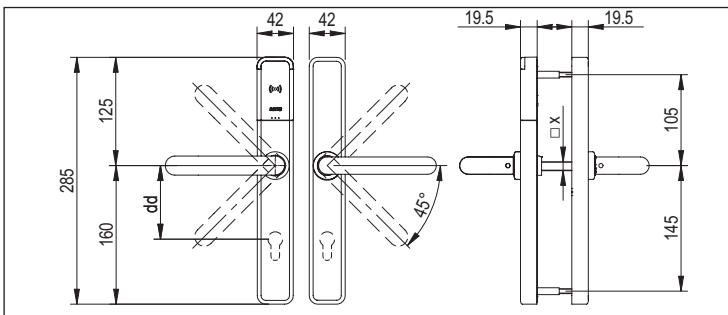

Prices - Gross prices		€
	BLE Mifare DESFire: Standard - standard square spindles, finishes and handles.	512,90
	BLE Mifare DESFire: Standard - 9mm square spindle, finishes and handles.	542,40
	Mifare DESFire: Standard - standard square spindles, finishes and handles.	484,45
	Mifare DESFire: Standard - 9mm square spindle, finishes and handles.	513,95
	BLE HID iCLASS: Standard - standard square spindles, finishes and handles.	656,50
	BLE HID iCLASS: Standard - 9mm square spindle, finishes and handles.	694,25

Technology	Escutcheon width	Function	Handle	Handle to thumbturn	Finish	Reader colour	Door thickness	Square spindle	Handing	Water resistance	Certification															
E9 Prox. Mifare DESFire	7	52	U	70	IM	B Black reader	3 32-47 mm	7 7mm	-	IP53	No certification															
			L	72					-																	
			W						-																	
			H ²	78	IP ²			4 45-60mm	8 8mm			-														
			I ²	7F								-														
			Y ²									-														
S ^{1,2}			3R	PP	6 60-75mm		R/L ¹		-																	
B ²			4R						-																	
P ²			7R						-																	
EB Prox. BLE Mifare DESFire			7	52			O ¹	7R	PM			9 9mm	9 9mm	-	IP55	P ⁴ PAS24 certification										
							J	85						-												
							T	88						-												
	EJ Prox. BLE HID iCLASS	7			52	Z	88	IA	7 75-90mm	S 8mm split	-			IP55			P ⁴ PAS24 certification									
G						90	-																			
N						92	-																			
EJ Prox. BLE HID iCLASS						7	52	K ¹			92							NE ²	9 90-105mm	V 9mm split	R/L ¹	IP55	P ⁴ PAS24 certification			
								2 ²			9R										-					
								3 ²			10										-					
	EJ Prox. BLE HID iCLASS							7	52	4 ²	10							BC ² BioCote			1 105-120mm			V 9mm split	-	IP55
5 ²										11	-															
7 ²										-	-															



¹ For Handed lever handles, only for S, O or K handles.

² This option has an additional price please refer to the handles or finishes chapter.

Additional Prices - Gross prices

Ref	Remarks	€
5 ³	Water resistant (IP55)	21,30
P ⁴	PAS24 certification	20,90

Model Ex753

SALTO XS4 ONE Electronic Escutcheon Ex753,
2 Handles, any type, Inside cylinder cut out.

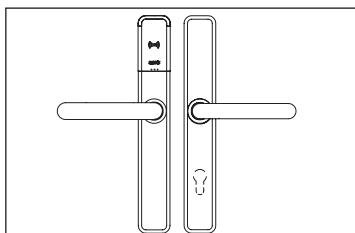

Mifare DESFire BLE
Mifare DESFire
HID iCLASS BLE

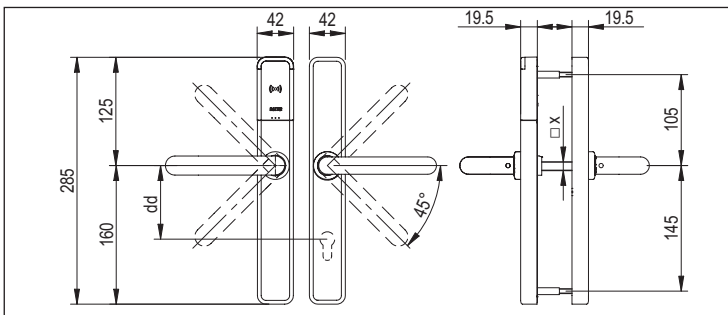

Prices - Gross prices		€
	BLE Mifare DESFire: Standard - standard square spindles, finishes and handles.	504,15
	BLE Mifare DESFire: Standard - 9mm square spindle, finishes and handles.	533,80
MIFARE DESFire	Mifare DESFire: Standard - standard square spindles, finishes and handles.	475,65
	Mifare DESFire: Standard - 9mm square spindle, finishes and handles.	505,40
	BLE HID iCLASS: Standard - standard square spindles, finishes and handles.	645,30
	BLE HID iCLASS: Standard - 9mm square spindle, finishes and handles.	683,25

Technology	Escutcheon width	Function	Handle	Handle to thumbturn	Finish	Reader colour	Door thickness	Square spindle	Handing	Water resistance	Certification									
E9 Prox. Mifare DESFire	7	53	U	47	IM	B Black reader	3 32-47 mm	7 7mm	-	IP53	-									
			L	48					-											
			W	49					-											
			H ²	55	IP ²		4 45-60mm	-												
			I ²	62				-												
			Y ²	70				-												
S ^{1,2}			72	PP	6 60-75mm		R/L ¹													
B ²			78				-													
P ²			78				-													
EB Prox. BLE Mifare DESFire			7	53	O ¹		7F	PM	7 75-90mm			9 9mm	R/L ¹	-	-					
					J		3R						-							
					T		4R						-							
					Z		7R	IA					8 8mm split			-				
					G		85									-				
					N		88									-				
EJ Prox. BLE HID iCLASS					7		53	K ¹	90			NE ²				9 90-105mm	S 8mm split	R/L ¹	5 ³ IP55	P ⁴ PAS24 certification
								2 ²	92									-		
								3 ²	92									-		
	4 ²	9R				BC ² BioCote		1 105-120mm	V 9mm split	-										
	5 ²	10								-										
	7 ²	11								-										



¹ For Handed lever handles, only for S, O or K handles.

² This option has an additional price please refer to the handles or finishes chapter.

Additional Prices - Gross prices

Ref	Remarks	€
5 ³	Water resistant (IP55)	21,30
P ⁴	PAS24 certification	20,90

Model Ex754

SALTO XS4 ONE Electronic Escutcheon Ex754,
2 Handles, any type, Outside cylinder cut out

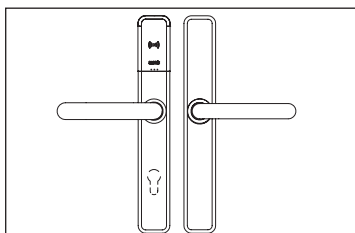

Mifare DESFire BLE
Mifare DESFire
HID iCLASS BLE

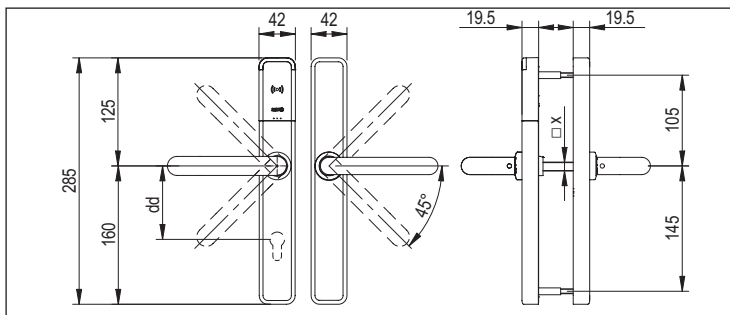

Prices - Gross prices	€
MIFARE DESFire BLE Mifare DESFire: Standard - standard square spindles, finishes and handles.	504,15
BLE Mifare DESFire: Standard - 9mm square spindle, finishes and handles.	533,30
MIFARE DESFire Mifare DESFire: Standard - standard square spindles, finishes and handles.	475,65
Mifare DESFire: Standard - 9mm square spindle, finishes and handles.	504,75
BLE HID iCLASS: Standard - standard square spindles, finishes and handles.	645,30
BLE HID iCLASS: Standard - 9mm square spindle, finishes and handles.	682,60

Technology	Escutcheon width	Function	Handle	Handle to thumbturn	Finish	Reader colour	Door thickness	Square spindle	Handing	Water resistance	Certification						
E9 Prox. Mifare DESFire	7	54	U	70	IM	B Black reader	3 32-47 mm	7 7mm	-	IP53	-						
			L	72					-								
			W						-								
			H ²	78	IP ²		4 45-60mm	-									
			I ²	7F				-									
			Y ²					-									
S ^{1,2}			3R	PP	8 8mm		R/L ¹										
B ²			4R				-										
P ²							-										
EB Prox. BLE Mifare DESFire			7	54	O ¹		7R	PM	6 60-75mm			9 9mm	R/L ¹	-	-		
					J		85						-				
					T								-				
	Z	88			IA	7 75-90mm	-										
G	90	-															
N		-															
EJ Prox. BLE HID iCLASS	7	54			K ¹	92	NE ²	W White reader	9 90-105mm	S 8mm split	R/L ¹	5 ³ IP55	P ⁴ PAS24 certification				
					2 ²	9R					-						
					3 ²						-						
					4 ²	10	BC ² BioCote				1 105-120mm					V 9mm split	-
					5 ²	-											-
7 ²					11	-											



¹ For Handed lever handles, only for S, O or K handles.

² This option has an additional price please refer to the handles or finishes chapter.

Additional Prices - Gross prices

Ref	Remarks	€
5 ³	Water resistant (IP55)	21,30
P ⁴	PAS24 certification	20,90

Model Ex756

SALTO XS4 ONE Electronic Escutcheon Ex756,
 2 Handles, any type, Electronic "do not disturb" system.

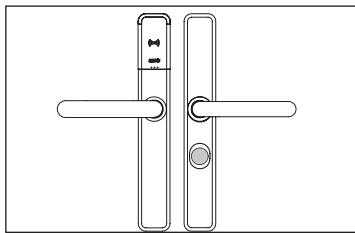

Mifare DESFire BLE
 Mifare DESFire
 HID iCLASS BLE

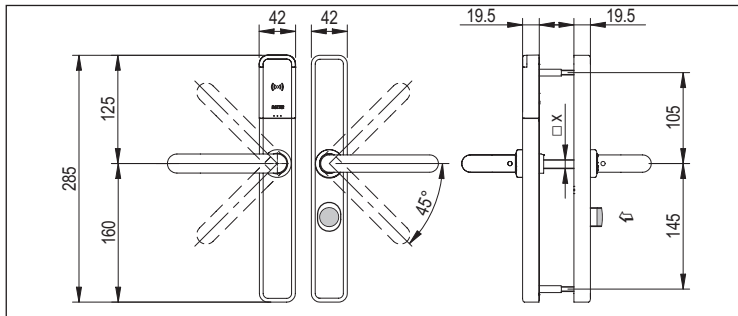

Prices - Gross prices		€
	BLE Mifare DESFire: Standard - standard square spindles, finishes and handles.	533,65
	BLE Mifare DESFire: Standard - 9mm square spindle, finishes and handles.	563,35
	Mifare DESFire: Standard - standard square spindles, finishes and handles.	505,25
	Mifare DESFire: Standard - 9mm square spindle, finishes and handles.	534,80
	BLE HID iCLASS: Standard - standard square spindles, finishes and handles.	683,05
	BLE HID iCLASS: Standard - 9mm square spindle, finishes and handles.	721,05

Technology	Escutcheon width	Function	Handle	Handle to thumbturn	Finish	Reader colour	Door thickness	Square spindle	Handing	Water resistance	Certification					
E9 Prox. Mifare DESFire	7	56	U	00 without distance	IM	B Black reader	2 F = 14,5mm	7 7 mm	-	IP53	-					
			L						-							
			W						-							
			H ²				8 8 mm	-								
			I ²					-								
			Y ²					-								
S ^{1,2}			9 9 mm	R/L ¹												
B ²				-												
P ²				-												
EB Prox. BLE Mifare DESFire			7	56	O ¹	7F 72mm for fire doors	PM	W White reader	B F = 19,5mm			9 9 mm	R/L ¹	5 ³ IP55	No specific certification	
					J								-			
					T								-			
	Z	S 8 mm split			-											
	G				-											
	N				-											
EJ Prox. BLE HID iCLASS	7	56			K ¹	7F 72mm for fire doors	IA	W White reader	5 F = 22mm	S 8 mm split	-	5 ³ IP55	No specific certification			
					2 ²						-					
					3 ²						-					
					4 ²				V 9 mm split	R/L ¹						
					5 ²					-						
					7 ²					-						
							NE ²	W White reader	7 75-90mm	V 9 mm split	R/L ¹			5 ³ IP55	No specific certification	
											9 90-105mm F = 16 - 58,5mm					-
											1 105-120mm F = 30 - 88,5mm					-
							BC ² BioCote	W White reader	6 7,6 mm split		-			5 ³ IP55	No specific certification	
											-					



¹ For Handed lever handles, only for S, O or K handles.

² This option has an additional price please refer to the handles or finishes chapter.

Additional Prices - Gross prices

Ref	Remarks	€
5 ³	Water resistant (IP55)	21,30

Model Ex757

SALTO XS4 ONE Electronic Escutcheon Ex757, 2 Handles, any type, Outside cylinder cut out, Electronic "do not disturb" system.

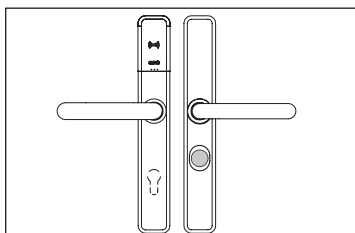

Mifare DESFire BLE
Mifare DESFire
HID iCLASS BLE

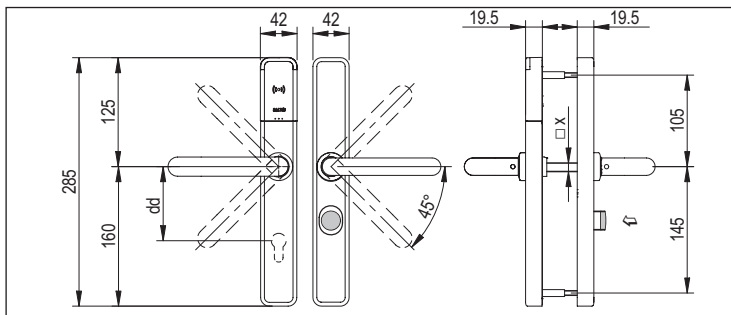

Prices - Gross prices		€
	BLE Mifare DESFire: Standard - standard square spindles, finishes and handles.	533,65
	BLE Mifare DESFire: Standard - 9mm square spindle, finishes and handles.	563,35
	Mifare DESFire: Standard - standard square spindles, finishes and handles.	505,25
	Mifare DESFire: Standard - 9mm square spindle, finishes and handles.	534,80
	BLE HID iCLASS: Standard - standard square spindles, finishes and handles.	683,05
	BLE HID iCLASS: Standard - 9mm square spindle, finishes and handles.	721,05

Technology	Escutcheon width	Function	Handle	Handle to thumbturn	Finish	Reader colour	Door thickness	Square spindle	Handing	Water resistance	Certification							
E9 Prox. Mifare DESFire	7	57	U	70	IM	B Black reader	3 32-47 mm	7 7mm	-	-	IP53							
			L	72					-									
			W						-									
			H ²	78	IP ²		4 45-60mm	-										
			I ²	7F				-										
			Y ²					-										
S ^{1,2}			3R	PP	8 8mm		R/L ¹											
B ²			4R				-											
P ²							-											
EB Prox. BLE Mifare DESFire			7	57	O ¹		7R	PM	6 60-75mm			9 9mm	R/L ¹	-	-	No specific certification		
					J		85						-					
					T								-					
	Z	88			IA	7 75-90mm	-											
G	90	-																
N		-																
EJ Prox. BLE HID iCLASS	7	57			K ¹	92	NE ²	W White reader	9 90-105mm	S 8mm split	R/L ¹	5 ³ IP55	-					
					2 ²	9R					-							
					3 ²						-							
					4 ²	10	BC ² BioCote				1 105-120mm						V 9mm split	-
					5 ²	-												-
7 ²					11	-												



¹ For Handed lever handles, only for S, O or K handles.

² This option has an additional price please refer to the handles or finishes chapter.

Additional Prices - Gross prices

Ref	Remarks	€
5 ³	Water resistant (IP55)	21,30

Model Ex7P0

SALTO XS4 ONE Electronic Escutcheon Ex7P0,
2 Handles, any type, Built in mechanical cylinder with audit,
(mechanical cylinder not included, for technical specifications consult SALTO)

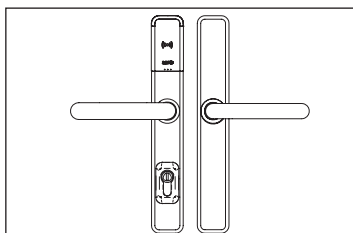

Mifare DESFire BLE
Mifare DESFire
HID iCLASS BLE

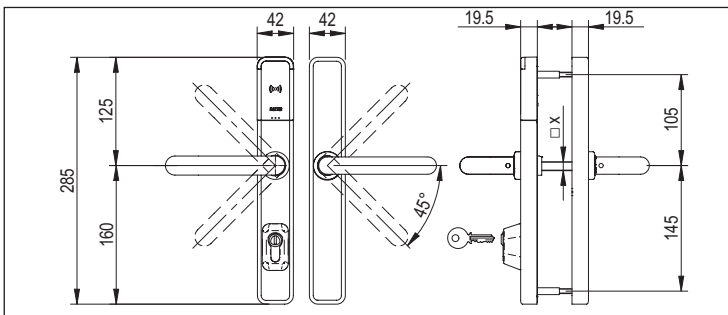

Prices - Gross prices

		€
	BLE Mifare DESFire: Standard - standard square spindles, finishes and handles.	513,40
	BLE Mifare DESFire: Standard - 9mm square spindle, finishes and handles.	543,10
	Mifare DESFire: Standard - standard square spindles, finishes and handles.	484,95
	Mifare DESFire: Standard - 9mm square spindle, finishes and handles.	514,65
	BLE HID iCLASS: Standard - standard square spindles, finishes and handles.	657,15
	BLE HID iCLASS: Standard - 9mm square spindle, finishes and handles.	695,15

Technology	Escutcheon width	Function	Handle	Handle to thumbturn	Finish	Reader colour	Door thickness	Square spindle	Handing	Water resistance	Certification		
E9 Prox. Mifare DESFire	7	P0	U	00 without distance	IM	B Black reader	2 F = 14,5mm	7 7 mm	-	IP53	-		
			L										
			W										
			H ²										
			I ²										
			Y ²										
EB Prox. BLE Mifare DESFire			S ^{1,2}		PM	B ²	W White reader	A F = 17mm	8 8 mm	-	R/L ¹	5 ³ IP55	P ⁴ PAS24 certification
						P ²							
						O ¹							
						J							
						T							
						Z							
EJ Prox. BLE HID iCLASS	G	NE ²	N	6 60-75mm	S 8 mm split	5 F = 22mm	-	-	6 7,6 mm split	-	-		
			K ¹										
			2 ²										
			3 ²										
			4 ²										
			5 ²										
7 ²													
					BC ² BioCote								



¹ For Handed lever handles, only for S, O or K handles.

² This option has an additional price please refer to the handles or finishes chapter.

Cylinders for the override Model P

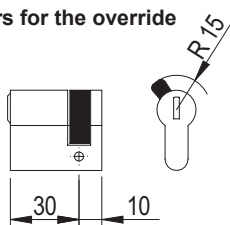

Additional Prices - Gross prices

Ref	Remarks	€
5 ³	Water resistant (IP55)	21,30
P ⁴	PAS24 certification	20,90

Model Ex7P1

SALTO XS4 ONE Electronic Escutcheon Ex7P1,
 2 Handles, any type, Inside thumbturn, built in mechanical cylinder with audit,
 (mechanical cylinder not included, for technical specifications consult SALTO)

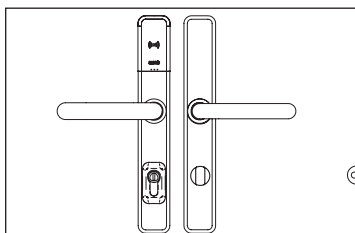

Mifare DESFire BLE
 Mifare DESFire
 HID iCLASS BLE

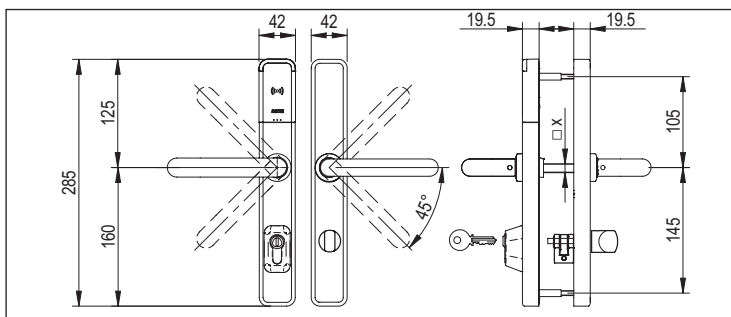

Prices - Gross prices		€
	BLE Mifare DESFire: Standard - standard square spindles, finishes and handles.	555,95
	BLE Mifare DESFire: Standard - 9mm square spindle, finishes and handles.	585,65
	Mifare DESFire: Standard - standard square spindles, finishes and handles.	527,55
	Mifare DESFire: Standard - 9mm square spindle, finishes and handles.	557,20
	BLE HID iCLASS: Standard - standard square spindles, finishes and handles.	711,60
	BLE HID iCLASS: Standard - 9mm square spindle, finishes and handles.	749,65

Technology	Escutcheon width	Function	Handle	Handle to thumbturn	Finish	Reader colour	Door thickness	Square spindle	Handing	Water resistance	Certification					
E9 Prox. Mifare DESFire	7	P1	U	47	IM	B Black reader	3 32-47 mm	7 7mm	-	IP53	No certification					
			L	48					-							
			W	49					-							
			H ²	55	IP ²		4 45-60mm	-								
			I ²	62				-								
			Y ²	70				-								
S ^{1,2}			72	PP	6 60-75mm		R/L ¹									
B ²			78				-									
P ²			78				-									
EB Prox. BLE Mifare DESFire			7	P1	O ¹		3R	PM	W White reader			9 9mm	R/L ¹	IP55	P ⁴ PAS24 certification	
					J		4R						-			
					T		7R	IA				7 75-90mm	-			
	Z	7R			-											
G	85	-														
EJ Prox. BLE HID iCLASS	7	P1			N	88	NE ²	W White reader		9 90-105mm	S 8mm split	R/L ¹	IP55			P ⁴ PAS24 certification
					K ¹	90						-				
					2 ²	92						-				
					3 ²	9R	BC ² BioCote			1 105-120mm	V 9mm split	-				
					4 ²	10						-				
					5 ²	10						-				
7 ²					11	-										



¹ For Handed lever handles, only for S, O or K handles.

² This option has an additional price please refer to the handles or finishes chapter.

Cylinders for the override
 Model P

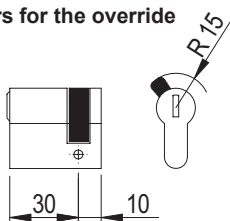

Additional Prices - Gross prices

Ref	Remarks	€
5 ³	Water resistant (IP55)	21,30
P ⁴	PAS24 certification	20,90

Model Ex7P6 SALTO XS4 ONE Electronic Escutcheon Ex7P6, 2 Handles, any type, electronic “do not disturb” system, built in mechanical cylinder with audit, (mechanical cylinder not included, for technical specifications consult SALTO)

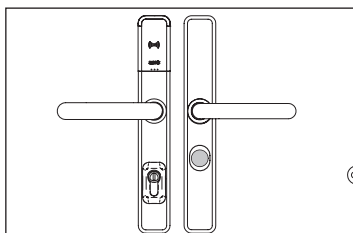

Mifare DESFire BLE
Mifare DESFire
HID iCLASS BLE

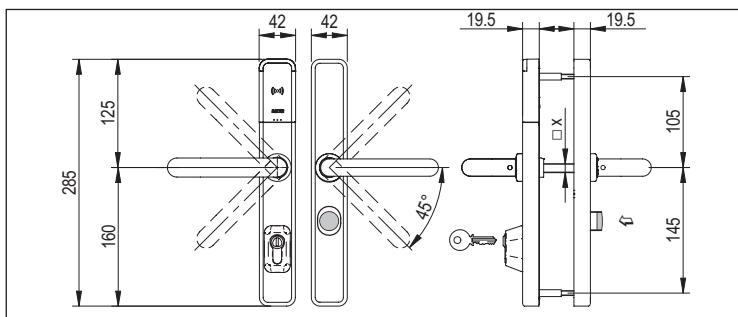

Prices - Gross prices		€
	BLE Mifare DESFire: Standard - standard square spindles, finishes and handles.	541,15
	BLE Mifare DESFire: Standard - 9mm square spindle, finishes and handles.	570,75
	Mifare DESFire: Standard - standard square spindles, finishes and handles.	512,70
	Mifare DESFire: Standard - 9mm square spindle, finishes and handles.	542,20
	BLE HID iCLASS: Standard - standard square spindles, finishes and handles.	692,65
	BLE HID iCLASS: Standard - 9mm square spindle, finishes and handles.	730,55

Technology	Escutcheon width	Function	Handle	Handle to thumbturn	Finish	Reader colour	Door thickness	Square spindle	Handing	Water resistance	Certification
E9 Prox. Mifare DESFire	7	P6	U	00 without distance	IM	B Black reader	2 F = 14,5mm	7 7 mm	-	IP53	-
			L						-		
			W						-		
			H ²						-		
			I ²						-		
			Y ²						-		
S ^{1,2}			R/L ¹								
EB Prox. BLE Mifare DESFire			B ²		PP	4 45-60mm	9 9 mm	-			
			P ²			-					
			O ¹			R/L ¹					
			J			-					
			T			-					
	Z	-									
EJ Prox. BLE HID iCLASS	G	IA	6 60-75mm	S 8 mm split	-						
	N		-								
	K ¹		W White reader		7 75-90mm	V 9 mm split	R/L ¹				
	2 ²				-						
	3 ²				-						
	4 ²				-						
	5 ²				-						
7 ²	-										
BC ² BioCote	6 7,6 mm split	-									
1 105-120mm F = 30 - 88,5mm	-										
9 90-105mm F = 16 - 58,5mm	-										



¹ For Handed lever handles, only for S, O or K handles.

² This option has an additional price please refer to the handles or finishes chapter.

Cylinders for the override
Model P

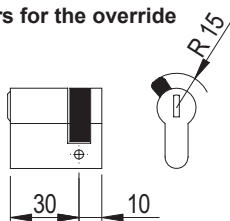

Additional Prices - Gross prices

Ref	Remarks	€
5 ³	Water resistant (IP55)	21,30

Model Ex750 DIN

SALTO XS4 ONE Electronic Escutcheon Ex750,
 for DIN fastening holes doors.
 2 Handles, any type.

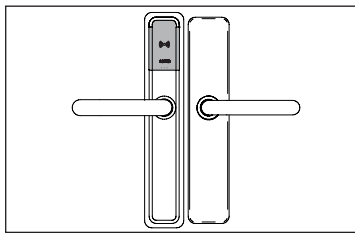

Mifare DESFire BLE
 Mifare DESFire
 HID iCLASS BLE

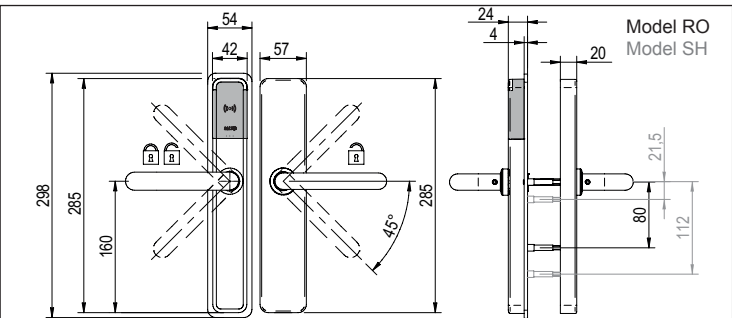

Prices - Gross prices		€
	BLE Mifare DESFire: Standard - standard square spindles, finishes and handles.	535,95
	BLE Mifare DESFire: Standard - 9mm square spindle, finishes and handles.	565,65
	BLE HID iCLASS: Standard - standard square spindles, finishes and handles.	686,00
	BLE HID iCLASS: Standard - 9mm square spindle, finishes and handles.	724,00

Technology	Escutcheon width	Function	Handle	Handle to thumbturn	Finish	Reader colour	Door thickness	Square spindle	Handing	Water resistance	Certification
EB Prox. BLE Mifare DESFire	7	50	U	RO DIN rose configuration plate	IM	B Black reader	3 32-47 mm	7 7mm	-	IP53	-
			L						-		
			W						-		
			H ²						-		
			I ²				8 8mm	-			
			Y ²					-			
			S ^{1,2}					R/L ¹			
			B ²				6 60-75mm	-			
			P ²					-			
			O ¹				9 9mm	R/L ¹			
J	-										
EJ Prox. BLE Mifare DESFire	7	50	T	SH DIN short plate configuration plate	PM	W White reader	7 75-90mm	S* 8mm split	-	IP53	No specific certification
			Z						-		
			G						-		
			N				9 90-105mm	R/L ¹			
			K ¹					-			
			2 ²		1* 105-120mm 30-120mm if split spindle		-				
			3 ²				-				
			4 ²				V* 9mm split	-			
			5 ²					-			
			7 ²		-						
					BC ²						



¹ For Handed lever handles, only for S, O or K handles.

² This option has an additional price please refer to the handles or finishes chapter.

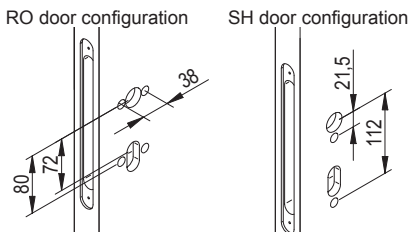

Model Ex756 DIN

SALTO XS4 ONE Electronic Escutcheon Ex756,
 for DIN fastening holes doors.
 2 Handles, any type, Electronic “do not disturb” system.

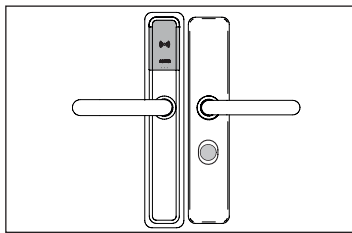

Mifare DESFire BLE
 Mifare DESFire
 HID iCLASS BLE

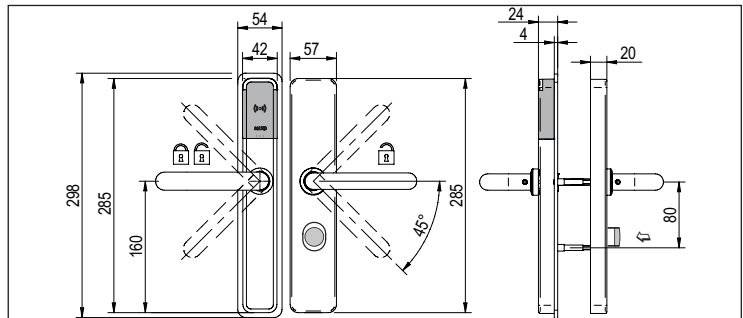

Prices - Gross prices



BLE Mifare DESFire: Standard - standard square spindles, finishes and handles.
BLE Mifare DESFire: Standard - 9mm square spindle, finishes and handles.

€

563,65

593,30



BLE HID iCLASS: Standard - standard square spindles, finishes and handles.
BLE HID iCLASS: Standard - 9mm square spindle, finishes and handles.

721,45

759,45

Technology	Escutcheon width	Function	Handle	Handle to thumbturn	Finish	Reader colour	Door thickness	Square spindle	Handing	Water resistance	Certification
EB Prox. BLE Mifare DESFire	7	56	U	RO DIN rose configuration plate	IM	B Black reader	3 32-47 mm	7 7mm	-	- IP53	- No specific certification
			L						-		
			W						-		
			H ²						-		
			I ²		8 8mm		-				
			Y ²				-				
			S ^{1,2}				R/L ¹				
			B ²		6 60-75mm		-				
			P ²				-				
			O ¹		9 9mm		R/L ¹				
EJ Prox. BLE Mifare DESFire	7	56	J	RO DIN rose configuration plate	PM	W White reader	7 75-90mm	9 9mm	-	- IP53	- No specific certification
			T						-		
			Z						-		
			G						-		
			N		S* 8mm split		-				
			K ¹				-				
			2 ²				R/L ¹				
			3 ²		9 90-105mm		-				
			4 ²				-				
			5 ²				-				
7 ²	V* 9mm split	-									
					BC ²	1* 105-120mm 30-120mm if split spindle					

RO door configuration



¹ For Handed lever handles, only for S, O or K handles.

² This option has an additional price please refer to the handles or finishes chapter.

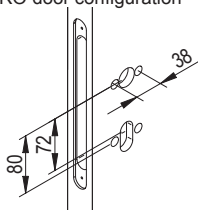

Model Ex7P0 DIN

SALTO XS4 ONE Electronic Escutcheon Ex7P0, for DIN fastening holes doors. 2 Handles, any type, built in mechanical cylinder with audit.
 (mechanical cylinder not included, for technical specifications consult SALTO).

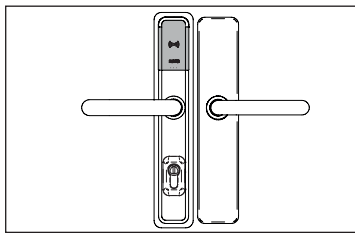

Mifare DESFire BLE
 Mifare DESFire
 HID iCLASS BLE

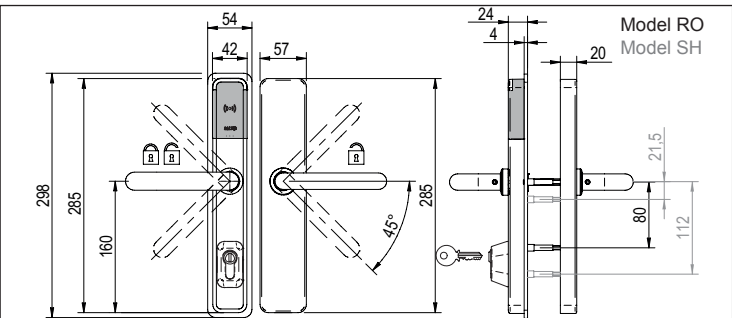

Prices - Gross prices €

	BLE Mifare DESFire: Standard - standard square spindles, finishes and handles.	543,45
	BLE Mifare DESFire: Standard - 9mm square spindle, finishes and handles.	573,05

	BLE HID iCLASS: Standard - standard square spindles, finishes and handles.	695,60
	BLE HID iCLASS: Standard - 9mm square spindle, finishes and handles.	733,50

Technology	Escutcheon width	Function	Handle	Handle to thumbturn	Finish	Reader colour	Door thickness	Square spindle	Handing	Water resistance	Certification
EB Prox. BLE Mifare DESFire	7	P0	U	RO DIN rose configuration plate	IM	B Black reader	3 32-47 mm	7 7mm	-	IP53	-
			L						-		
			W						-		
			H ²						-		
			I ²				8 8mm	-			
			Y ²					-			
			S ^{1,2}					R/L ¹			
			B ²				6 60-75mm	-			
			P ²					-			
			O ¹				9 9mm	R/L ¹			
J	-	-									
EJ Prox. BLE Mifare DESFire	7	P0	T	SH DIN short plate configuration plate	PM	W White reader	7 75-90mm	S* 8mm split	-	IP53	No specific certification
			Z						-		
			G						-		
			N				9 90-105mm	-			
			K ¹					R/L ¹			
			2 ²		V* 9mm split		-				
			3 ²				-				
			4 ²				-				
			5 ²				-				
			7 ²		1* 105-120mm 30-120mm if split spindle		-				



¹ For Handed lever handles, only for S, O or K handles.

² This option has an additional price please refer to the handles or finishes chapter.

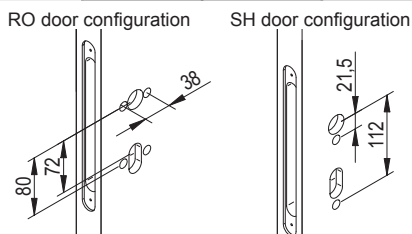

Model Ex7P6 DIN

SALTO XS4 ONE Electronic Escutcheon Ex7P6, for DIN fastening holes doors.2 Handles, any type, Electronic “do not disturb” system, built in mechanical cylinder with audit, (mechanical cylinder not included, for technical specifications consult).

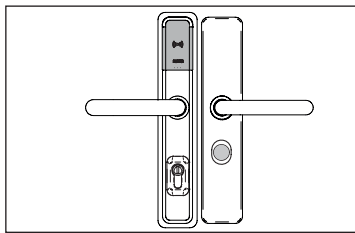

Mifare DESFire BLE
Mifare DESFire
HID iCLASS BLE

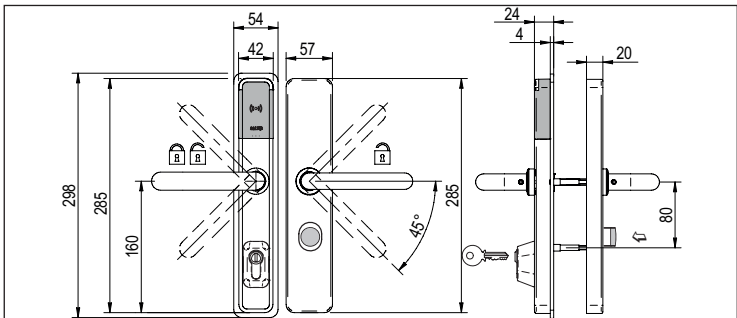

Prices - Gross prices €

	BLE Mifare DESFire: Standard - standard square spindles, finishes and handles.	571,20
	BLE Mifare DESFire: Standard - 9mm square spindle, finishes and handles.	600,85

	BLE HID iCLASS: Standard - standard square spindles, finishes and handles.	731,15
	BLE HID iCLASS: Standard - 9mm square spindle, finishes and handles.	769,05

Technology	Escutcheon width	Function	Handle	Handle to thumbturn	Finish	Reader colour	Door thickness	Square spindle	Handing	Water resistance	Certification
EB Prox. BLE Mifare DESFire	7	P6	U	RO DIN rose configuration plate	IM	B Black reader	3 32-47 mm	7 7mm	-	- IP53	- No specific certification
			L								
			W								
			H ²								
			I ²								
			Y ²								
			S ^{1,2}								
			B ²								
			P ²								
			O ¹								
EJ Prox. BLE Mifare DESFire	7	P6	J	RO DIN rose configuration plate	PM	W White reader	7 75-90mm	9 9mm	-	- IP53	- No specific certification
			T								
			Z								
			G								
			N								
			K ¹								
			2 ²								
			3 ²								
			4 ²								
			5 ²								
7 ²											
					BC ²	9 90-105mm	S* 8mm split	R/L ¹	- IP53	- No specific certification	
						1* 105-120mm 30-120mm if split spindle	V* 9mm split	-	- IP53	- No specific certification	



¹ For Handed lever handles, only for S, O or K handles.

² This option has an additional price please refer to the handles or finishes chapter.

RO door configuration

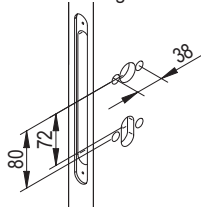

Cylinders for the override for model P

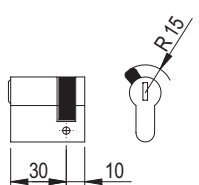

Model E0700

SALTO XS4 Electronic Escutcheon E0700, Complementary, 2 handles, any type.

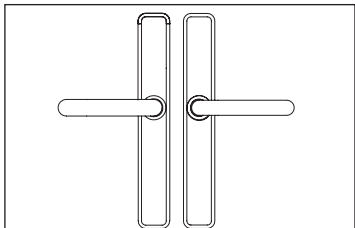

¹ For Handed lever handles, only for S, O or K handles.

² This option has an additional price, please refer to the handles or finishes chapter.

Prices - Gross prices							€
Standard - standard square spindles, finishes and handles.							118,30
Standard - 9mm square spindle, finishes and handles.							147,00
Technology	Escutcheon width	Function	Handle	Handle to thumbturn	Finish	Door thickness	Square spindle
E0	7	00	U	00 without distance	IM0	3 32-47 mm	7 7 mm
			L				
			W				
			H ²				
			I ²				
			Y ²				
			S ^{1,2}				
			B ²				
			P ²				
			O ¹				
			J	7F 72mm for fire doors	PM0	6 60-75mm	8 8 mm
			T				
			Z				
			G				
			N				
			K ¹		NE0 ²	9 90-105mm	9 9 mm
			2 ²				
			3 ²				
			4 ²				
			5 ²		BC0 ² BioCote	1 105-120mm	
7 ²							

Model E0701

SALTO XS4 Electronic Escutcheon E0701, Complementary, 2 handles, any type, inside thumbturn.

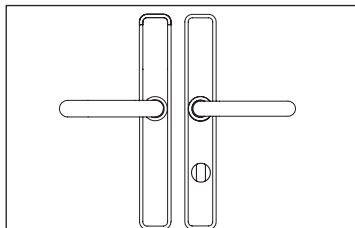

¹ For Handed lever handles, only for S, O or K handles.

² This option has an additional price, please refer to the handles or finishes chapter.

Prices - Gross prices							€
Standard - standard square spindles, finishes and handles.							151,55
Standard - 9mm square spindle, finishes and handles.							180,35
Technology	Escutcheon width	Function	Handle	Handle to thumbturn	Finish	Door thickness	Square spindle
E0	7	01	U	47	IM0	3 32-47 mm	7 7 mm
			L	48			
			W	49			
			H ²	55			
			I ²	62			
			Y ²	70			
			S ^{1,2}	72			
			B ²	78			
			P ²	7F			
			O ¹	7F			
			J	3R	PM0	6 60-75mm	8 8 mm
			T	4R			
			Z	7R			
			G	85			
			N	88			
			K ¹	90	NE0 ²	9 90-105mm	9 9 mm
			2 ²	92			
			3 ²	9R			
			4 ²	10	BC0 ² BioCote	1 105-120mm	
			5 ²	11			

Model E07C1

SALTO XS4 Electronic Escutcheon E07C1, Complementary, 2 handles, any type, inside thumbturn, outside coin override.

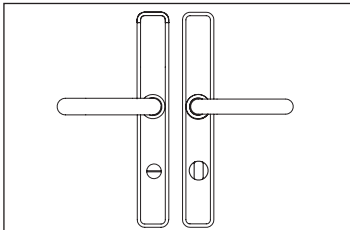

¹ For Handed lever handles, only for S, O or K handles.

² This option has an additional price, please refer to the handles or finishes chapter.

Prices - Gross prices	€
Standard - standard square spindles, finishes and handles.	164,50
Standard - 9mm square spindle, finishes and handles.	193,30

Technology	Escutcheon width	Function	Handle	Handle to thumbturn	Finish	Door thickness	Square spindle
E0	7	C1	U	55	IM0	3 32-47 mm	7 7 mm
			L	62			
			W	70			
			H ²	72	IP0 ²	4 45-60mm	
			I ²	78			
			Y ²	7F			
			S ^{1,2}	7F	PP0	6 60-75mm	8 8 mm
			B ²	3R			
			P ²	4R			
			O ¹	7R	PM0	7 75-90mm	
			J	85			
			T	88			
			Z	90	IA0	9 90-105mm	9 9 mm
			G	92			
			N	9R			
			K ¹	10	NE0 ²	1 105-120mm	
			2 ²	11			
			3 ²				
4 ²		BC0 ² BioCote					
5 ²							
7 ²							

Model E0702

SALTO XS4 Electronic Escutcheon E0702, Complementary, 2 handles, any type, inside/outside cylinder cut out.

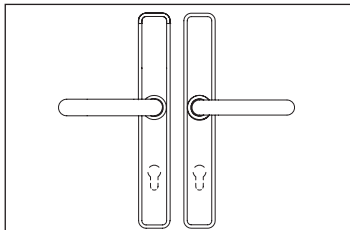

¹ For Handed lever handles, only for S, O or K handles.

² This option has an additional price, please refer to the handles or finishes chapter.

Prices - Gross prices	€
Standard - standard square spindles, finishes and handles.	127,45
Standard - 9mm square spindle, finishes and handles.	156,25

Technology	Escutcheon width	Function	Handle	Handle to thumbturn	Finish	Door thickness	Square spindle
E0	7	02	U	70	IM0	3 32-47 mm	7 7 mm
			L	72			
			W	78			
			H ²	7F	IP0 ²	4 45-60mm	
			I ²	7F			
			Y ²	3R			
			S ^{1,2}	4R	PP0	6 60-75mm	8 8 mm
			B ²	7R			
			P ²	85			
			O ¹	88	PM0	7 75-90mm	
			J	90			
			T	92			
			Z	9R	IA0	9 90-105mm	9 9 mm
			G	10			
			N	11			
			K ¹		NE0 ²	1 105-120mm	
			2 ²				
			3 ²				
4 ²		BC0 ² BioCote					
5 ²							
7 ²							

Model E0703

SALTO XS4 Electronic Escutcheon E0703, Complementary, 2 handles, any type, inside cylinder cut out.

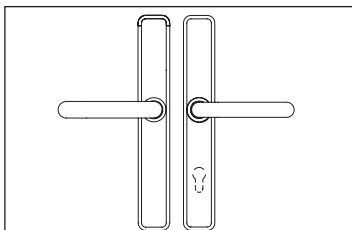

¹ For Handed lever handles, only for S, O or K handles.

² This option has an additional price, please refer to the handles or finishes chapter.

Prices - Gross prices							€
Standard - standard square spindles, finishes and handles.							127,45
Standard - 9mm square spindle, finishes and handles.							156,25
Technology	Escutcheon width	Function	Handle	Handle to thumbturn	Finish	Door thickness	Square spindle
E0	7	03	U	47	IM0	3 32-47 mm	7 7 mm
			L	48			
			W	49			
			H ²	55	IP0 ²	4 45-60mm	
			I ²	62			
			Y ²	70			
			S ^{1,2}	72	PP0	6 60-75mm	8 8 mm
			B ²	78			
			P ²	7F			
			O ¹	3R	PM0	7 75-90mm	
			J	4R			
			T	7R			
			Z	85	IA0	9 90-105mm	9 9 mm
			G	88			
			N	90			
			K ¹	92	NE0 ²	1 105-120mm	
			2 ²	9R			
			3 ²	10			
			4 ²	11	BC0 ² BioCote		
			5 ²				
7 ²							

Model E0704

SALTO XS4 Electronic Escutcheon E0704, Complementary, 2 handles, any type, outside cylinder cut out.

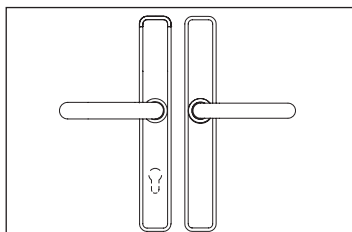

¹ For Handed lever handles, only for S, O or K handles.

² This option has an additional price, please refer to the handles or finishes chapter.

Prices - Gross prices							€
Standard - standard square spindles, finishes and handles.							127,45
Standard - 9mm square spindle, finishes and handles.							156,25
Technology	Escutcheon width	Function	Handle	Handle to thumbturn	Finish	Door thickness	Square spindle
E0	7	04	U	70	IM0	3 32-47 mm	7 7 mm
			L	72			
			W	78			
			H ²	7F	IP0 ²	4 45-60mm	
			I ²	3R			
			Y ²	4R			
			S ^{1,2}	7R	PP0	6 60-75mm	8 8 mm
			B ²	85			
			P ²	88			
			O ¹	90	PM0	7 75-90mm	
			J	92			
			T	9R			
			Z	10	IA0	9 90-105mm	9 9 mm
			G	11			
			N				
			K ¹		NE0 ²	1 105-120mm	
			2 ²				
			3 ²				
			4 ²		BC0 ² BioCote		
			5 ²				
7 ²							

Model E0709



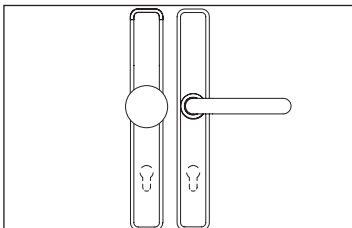

SALTO XS4 Electronic Escutcheon E0709, Complementary,
2 Handles, any type, outside knob, outside and inside cylinder cut out.



¹ For Handed lever handles, only for S, O or K handles.

² This option has an additional price, please refer to the handles or finishes chapter.

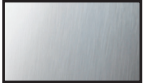
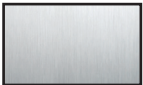
Prices - Gross prices							€
Standard - standard square spindles, finishes and handles.							137,70
Standard - 9mm square spindle, finishes and handles.							166,50
Technology	Escutcheon width	Function	Handle	Handle to thumbturn	Finish	Door thickness	Square spindle
E0	7	09	U	00 no cylinder	IM0	3 32-47 mm	7 7 mm
			L				
			W				
			H ²	70	IP0 ²	4 45-60mm	
			I ²	72			
			Y ²	78			
			S ^{1,2}	7F	PP0	6 60-75mm	
			B ²	3R			
			P ²	4R	PM0	7 75-90mm	
			O ¹	7R			
			J	85			
			T	88	IA0	9 90-105mm	
			Z	90			
			G	92	NE0 ²	9 9 mm	
			N	9R			
			K ¹	10			
			2 ²	11			
			3 ²				
			4 ²		BC0 ² BioCote	1 105-120mm	
			5 ²				
7 ²							

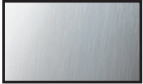
Product description	Product reference	€
Brass finishes		
Polished brass Cover plates made of stainless steel with a PVD coating. Handles made of stainless steel with a PVD coating except O handle which is made in brass with PVD coating.		E X X X X X X P P X X
Antique brass Cover plates made of stainless steel with a special finish simulating antique brass.		E X X X X X X I A X X
Satin brass Cover plates made of stainless steel with a PVD coating. Handles made of stainless steel with a PVD coating except O handle which is made in brass with PVD coating.		E X X X X X X P M X X
Stainless steel finishes		
Satin stainless steel		E X X X X X X I M X X
Polished stainless steel		E X X X X X X I P X X
RAL colours		
Black		E X X X X X X N E X X
BioCote antimicrobial finishes		
SALTO BioCote finish Cover plates made of stainless steel with a Biocote antimicrobial coating.		E X X X X X X BC X X

Example of price calculation for finishes other than Satin Stainless (IM), which is the standard used in our price list.

Required is EB750U00NEB3 escutcheon.	€
EB750U00IMB3	505,90
Additional price for Black finish	24,90
Total Price:	530,80

 Please note that brass finishes may become discoloured over time due to their exposure to environmental conditions such as humidity, pollution and salt air. Rings and keys can also scratch the brass lacquer finish and once this has started to occur, discolouration will likely begin.

Escutcheon handles

Only those handles regarded as off-set handles have an add-on to the price of the standard escutcheon. 2 remarks:

- Prices are gross and per handle, so an EB750 model, for instance, needs 2 handles in the case of an off-set model.
- Prices refer to the IM finish, so please refer to the finishes pricelist in order to establish final price of the product.

FINISH MODEL	PVD							Spindle available			Gross price
	SATIN STAINLESS STEEL	POLISHED STAINLESS STEEL	POLISHED BRASS COLOUR	SATIN BRASS COLOUR	ANTIQUE BRASS COLOUR	BLACK	BIOCOTE	DUAL 8-7 ^{diamond}	8	9	€
	IM	IP	PP	PM	IA	NE	BC				
	U	✓	✓	✓	✓	✓	✓	✓	✓	✓	0,00
	L	✓	✓	✓	✓	✓	✓	✓	✓	✓	0,00
	W	✓	✓	✓	✓	✓	✓	✓	✓	✓	0,00
	H	✓						✓	✓		30,15
	S	✓						✓			30,15
	B	✓						✓			71,05
	P	✓						✓			44,35
	J	✓			✓	✓	✓	✓	✓		0,00
	T	✓			✓		✓	✓	✓		0,00
	Y	✓	✓					✓	✓		30,15
	Z	✓			✓		✓	✓	✓		0,00
	O	✓	✓	✓	✓	✓	✓				0,00
	N	✓			✓		✓	✓	✓		0,00
	G	✓			✓		✓	✓	✓		30,15
	K	✓	✓	✓					✓		0,00
	I	✓						✓	✓		30,15
	2	✓	✓	✓					✓		37,30
	3	✓	✓	✓					✓		37,30
	4	✓	✓	✓					✓		37,30
	7	✓	✓	✓					✓		37,30
	5	✓	✓	✓					✓		37,30

*All handles are made from Stainless Steel, except the "O" handle which is Brass and the K, 2, 3, 4, 5, 7 are made of Zamack.

**L-R= Handed models.

The Y handle, means Y on the outside and W on the inside. The I handle, means I on the outside and J on the inside.

The Z handle, means "Inside handle fixed only with a socket set screw"



SALTO escutcheon reference example

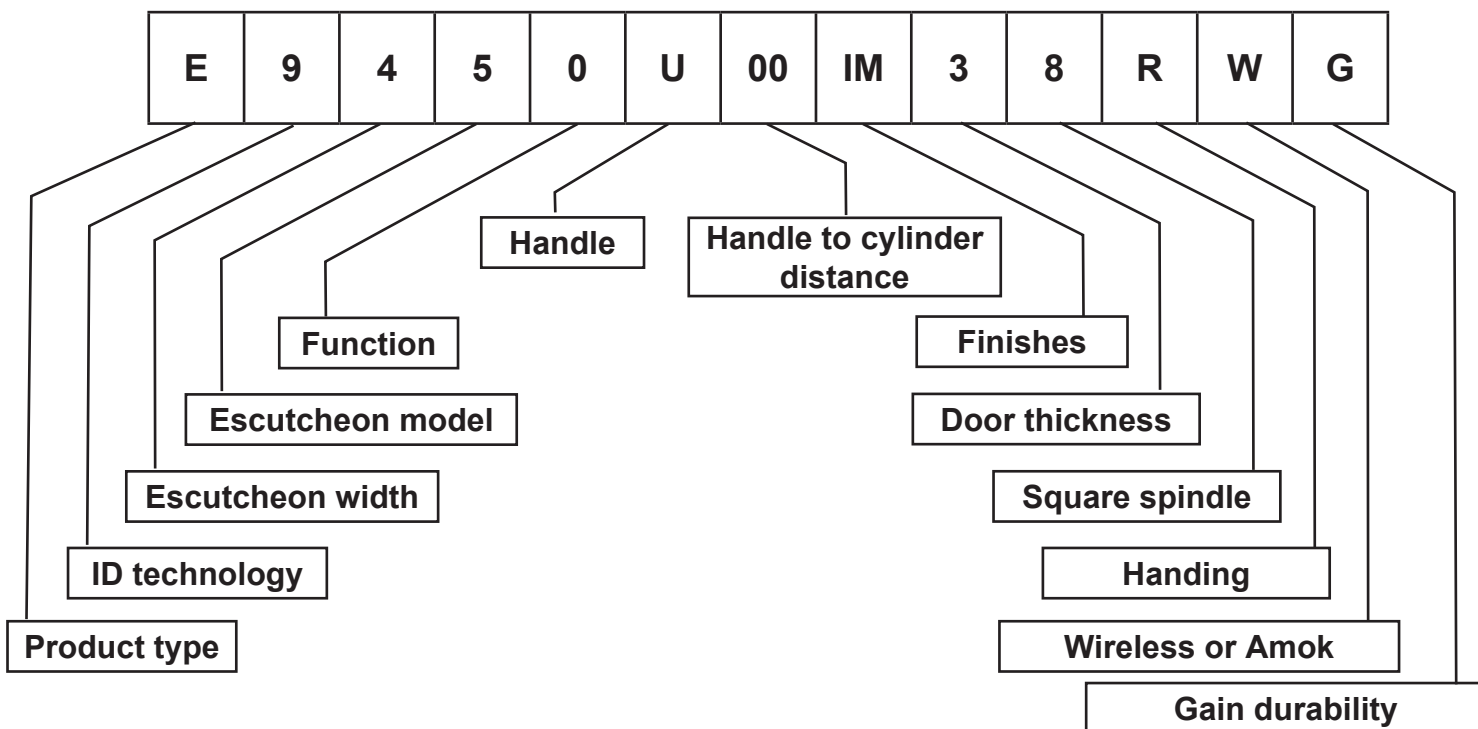

Product type:

E = European escutcheons compatible with European mortise locks.

A = ANSI escutcheons compatible with ANSI mortise locks.

S = Scandinavian escutcheons compatible with Scandinavian mortise locks.

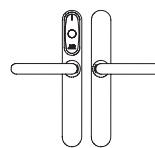

European escutcheons

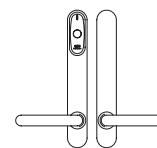

Scandinavian escutcheons

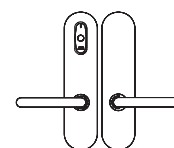

ANSI escutcheons

ID technology

RFID

- 7 = Contactless Inside Picopass
- 8 = Contactless LEGIC advant & prime
- 9 = Contactless Mifare / DESFire
- H = Contactless HID iCLASS
- B = Contactless BLE Mifare DESFire
- J = Contactless BLE HID iCLASS

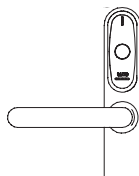

Handle set width:

- 4 = 40 mm
- 5 = 55 mm
- 6 = 67 mm

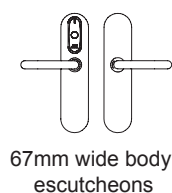
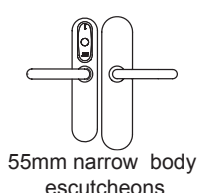
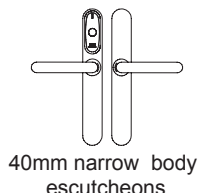

Escutcheon model:

- 5 = Clutch
- 6 = Clutch + override
- P = Clutch + Euro profile cilinder override
- K = SKG model (just for European narrow body escutcheons)

(6) Clutch + mechanical override 6 means: mortise cylinder 1-1/8" for ANSI and wide body european escutcheons.

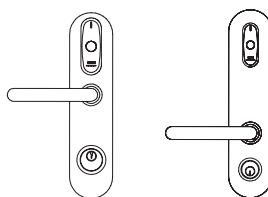

Clutch + mechanical override P means: Euro profile cylinder mechanical override for European narrow or wide body escutcheons.

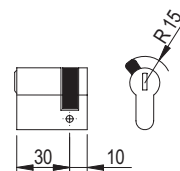
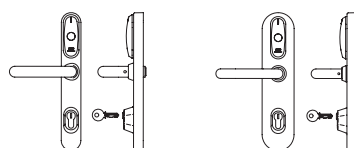

Handles

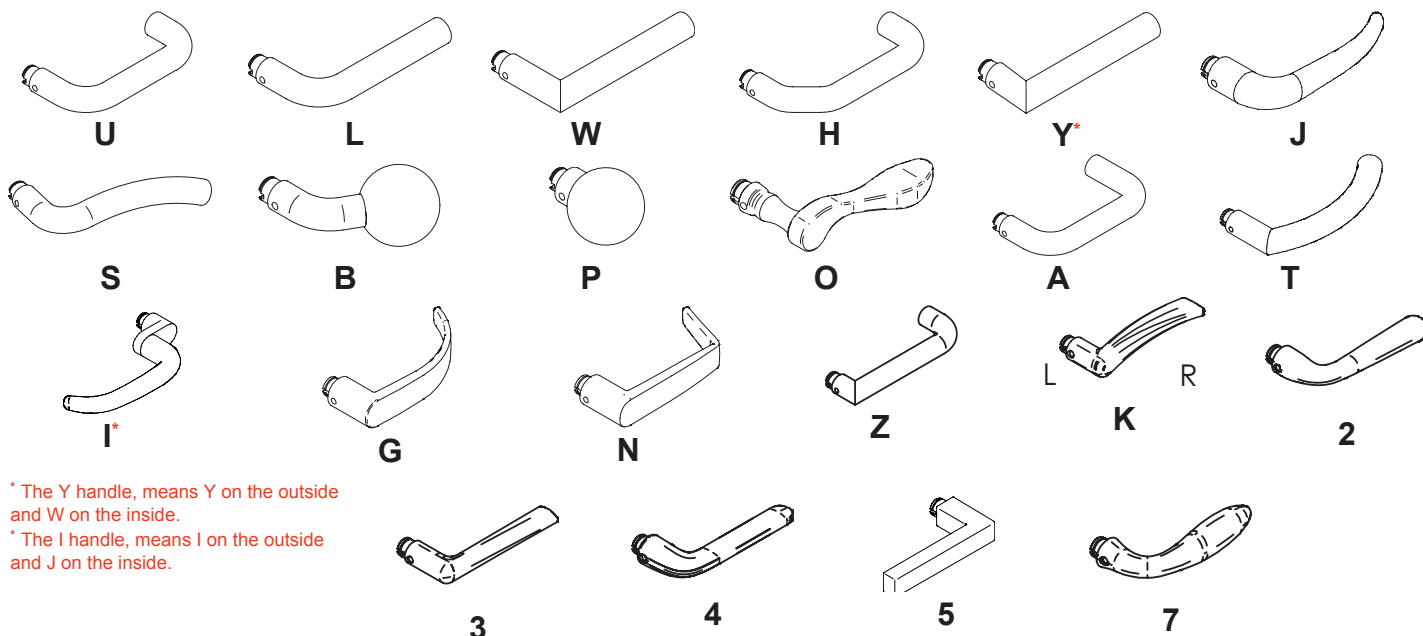

* The Y handle, means Y on the outside and W on the inside.
* The I handle, means I on the outside and J on the inside.

Distance to cylinder

- 00 = without distance
- 47 = 47mm euro profile cylinder
- 48 = 48mm euro profile cylinder
- 49 = 49mm euro profile cylinder
- 55 = 55mm euro profile cylinder
- 62 = 62mm euro profile cylinder
- 70 = 70mm euro profile cylinder
- 72 = 72mm euro profile cylinder
- 7F = 72mm for fire doors
- 78 = 78mm euro profile cylinder
- 3R = 73,5mm swiss profile cylinder
- 4R = 74mm swiss profile cylinder
- 7R = 78mm swiss profile cylinder
- 85 = 85mm euro profile cylinder
- 88 = 88mm euro profile cylinder
- 90 = 90mm euro profile cylinder
- 92 = 92 mm euro profile cylinder
- 9R = 94mm swiss profile cylinder
- 10 = 100mm euro profile cylinder
- 11 = 110mm euro profile cylinder



Fire doors mortise locks

For DIN Fastening Holes doors (Models Ex550, Ex556, Ex-5P0,E5P6)

RO = Rose configuration

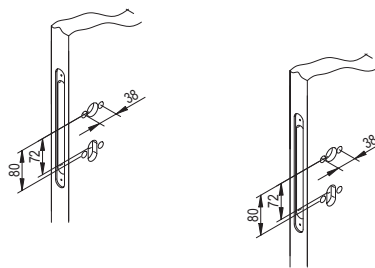

SH= Short plate configuration

Finishes

- IM = Satin stainless steel
- IP = Bright stainless steel
- PP = Bright Brass
- PM = Satin Brass
- IA = Antique Brass
- NE = Black
- BC = BioCote - antimicrobial finish



Satin stainless steel



Bright stainless steel



Bright Brass PVD



Satin Brass PVD



Antique Brass



Black



BioCote finish



The BioCote and IA finish is 'painted' and sharp objects such as rings and other metallic objects as well as harsh and abrasive chemicals should be avoided during any cleaning process.

Door thickness

- 3 = 32-47mm.
- 4 = 45-60mm.
- 6 = 60-75mm.
- 7 = 75-90mm.
- 9 = 90-105mm.
- 1 = 105-120mm.



For 7,6 spindle check chart below. The door thickness must be defined by the distance Fo (distance from the edge of the door to the HUB).

*** Note** if you have a cover plate you will need to add 1.5mm to Fo.

Door thickness 7,6 split spindle	Fo	Co Outside Spindle	Fi Inside Spindle	P Door Thickness (Orientative)
2	15 - 17.5 mm	9 - 11.5 mm	68mm	32 - 53 mm
A	17.5 - 20 mm	11.5 - 14 mm		
B	20 - 22.5 mm	14 - 16.5 mm		
5	22.5 - 25 mm	16.5 - 19 mm	70 - 100.5mm	50 - 90 mm
9	16.5 - 59 mm	19 - 54.5 mm		
1	30.5 - 89 mm	54.5 - 81.5 mm		

↑ Ref =9,1 Necessary to cut to measure

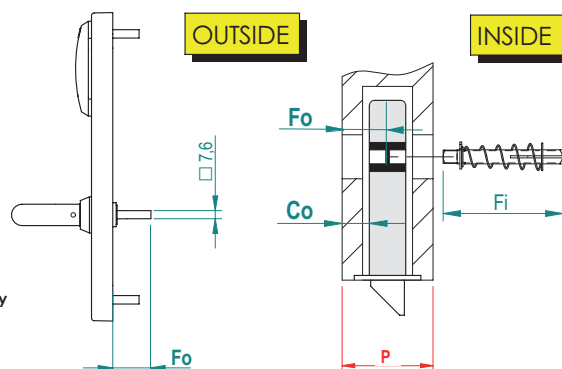

Handle handing

R = Right hand.
L = Left hand.
just for O, K and S handles

R	RIGHT HAND
L	LEFT HAND

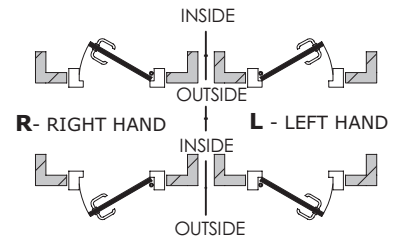

Wireless

- = Standalone wire free SVN escutcheon.

C = Offline escutcheon with convertible module that can be upgraded to a wireless escutcheon just by adding the wireless antenna kit.

W = Wireless online escutcheon.

Keypad function

K = Keypad Function

Keypad Function is a special function that permits to use a PIN code, a lock code or card plus PIN to operate the electronic escutcheon.

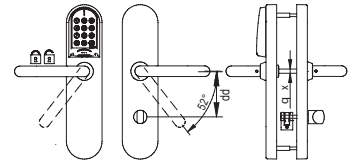

Keypad escutcheons are just available for MIFARE DESFire and HID technologies, and are compatible with Wireless.

Amok function

A = Amok Function

Amok Function is a special function that permits to put the electronic escutcheon in a standalone lockdown mode just by presenting a user card that have the Amok capability on his access plan in the inside reader of the escutcheon.



BLE Mifare DESFire escutcheons are not available in Amok version.

Wireless mode and Amok mode are not compatibles and can not be available in the same escutcheon.

Amok escutcheons are not scalable, and can not be programmed as self-programmable or ROM system. Just available for RW systems

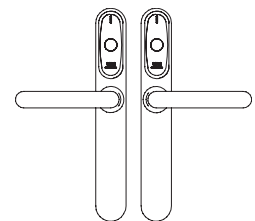

Gain durability

- = Standard product

G = Gained durability for high transit and heavy doors.

Model Ex450

SALTO XS4 Electronic Escutcheon Ex450,
2 Handles, any type.

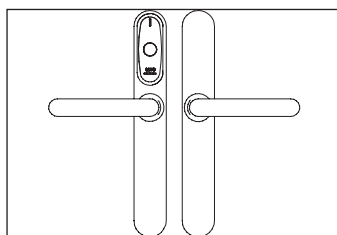

Inside Picopass
LEGIC advant - Prime
Mifare - DESFire
BLE Mifare DESFire
HID iCLASS
BLE HID iCLASS

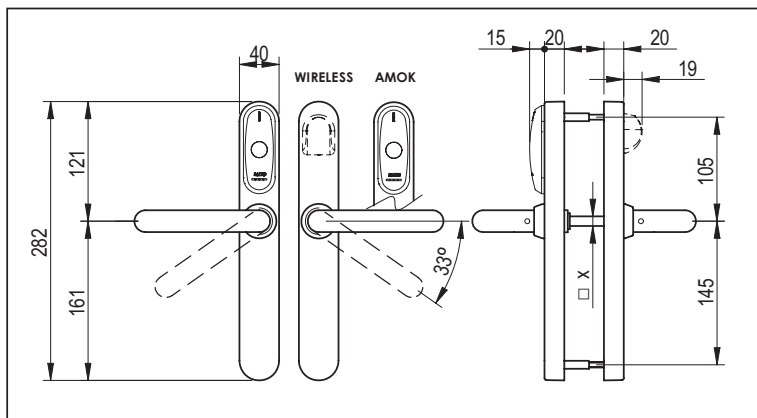

Technology	Escutcheon width	Function	Handle	Handle to thumbturn	Finish	Door thickness	Square spindle	Handing	Wireless option	Gain durability
E7 PICOPASS	4	50	U	00 without distance	IM	2 Fo = 15-17,5mm	7 7mm	-	-	-
			L			-				
			W			-				
E8 LEGIC			H ²		IP ²	3 32-47 mm	-			
			I ²			8 8mm	-			
			Y ²				-			
E9 MIFARE			S ^{1,2}	PP	4 45-60mm	-	9 9mm	R/L ¹	C Convertible	
			B ²			-				
			P ²		-					
EB MIFARE BLE			O ¹	PM	5 Fo = 20-22,5mm	-	S 8mm split	-	W Wireless	
			J			-				
			T			-				
EH HID iCLASS	Z	IA	6 60-75mm	-	V 9mm split	R/L ¹	A ³ Amok			
	G			-						
	N			-						
EJ BLE HID iCLASS	K ¹	NE ²	7 75-90mm	-	6 7,6mm split	-	G Gain durability			
	2 ²			-						
	3 ²			-						
	4 ²	BC ² BioCote	9 90-105mm Fo = 16.5 -59mm	-	1 105-120mm Fo = 30.5 - 89mm	-				
	5 ²			-						
	7 ²			-						
				7F 72mm for fire doors						

Additional Prices - Gross prices



¹ For Handed lever handles, only for S, O or K handles.

² This option has an additional price please refer to the handles or finishes chapter.

³ Not available in BLE Mifare DESFire.

Ref	Remarks	€
G	Gain durability	21,30

Model Ex450	SALTO XS4 Electronic Escutcheon Ex450, 2 Handles, any type.
--------------------	--

Prices - Gross prices	€
------------------------------	---



Picopass: Standard - standard square spindles, finishes and handles.	488,00
Picopass: Standard - 9mm square spindle, finishes and handles.	516,85
Picopass: Wireless convertible - standard square spindles, finishes and handles.	526,75
Picopass: Wireless convertible - 9mm square spindle, finishes and handles.	555,70
Picopass: Wireless - standard square spindles, finishes and handles.	624,65
Picopass: Wireless - 9mm square spindle, finishes and handles.	653,40
Picopass: Amok - standard square spindles, finishes and handles.	657,90
Picopass: Amok - 9mm square spindle, finishes and handles.	686,80



Legic: Standard - standard square spindles, finishes and handles.	464,70
Legic: Standard - 9mm square spindle, finishes and handles.	493,50
Legic: Wireless convertible - standard square spindles, finishes and handles.	503,55
Legic: Wireless convertible - 9mm square spindle, finishes and handles.	532,35
Legic: Wireless - standard square spindles, finishes and handles.	601,35
Legic: Wireless - 9mm square spindle, finishes and handles.	630,10
Legic: Amok - standard square spindles, finishes and handles.	589,85
Legic: Amok - 9mm square spindle, finishes and handles.	618,65



Mifare DESFire: Standard - standard square spindles, finishes and handles.	464,70
Mifare DESFire: Standard - 9mm square spindle, finishes and handles.	493,50
Mifare DESFire: Wireless convertible - standard square spindles, finishes and handles.	503,55
Mifare DESFire: Wireless convertible - 9mm square spindle, finishes and handles.	532,35
Mifare DESFire: Wireless - standard square spindles, finishes and handles.	601,35
Mifare DESFire: Wireless - 9mm square spindle, finishes and handles.	630,10
Mifare DESFire: Amok - standard square spindles, finishes and handles.	589,85
Mifare DESFire: Amok - 9mm square spindle, finishes and handles.	618,65



BLE Mifare DESFire: additional price to add to the Mifare DESFire price. Gross price	27,70
---	-------



HID iCLASS: Standard - standard square spindles, finishes and handles.	586,15
HID iCLASS: Standard - 9mm square spindle, finishes and handles.	615,00
HID iCLASS: Wireless convertible - standard square spindles, finishes and handles.	625,00
HID iCLASS: Wireless convertible - 9mm square spindle, finishes and handles.	653,80
HID iCLASS: Wireless - standard square spindles, finishes and handles.	722,75
HID iCLASS: Wireless - 9mm square spindle, finishes and handles.	751,65
HID iCLASS: Amok - standard square spindles, finishes and handles.	867,35
HID iCLASS: Amok - 9mm square spindle, finishes and handles.	896,20



BLE HID iCLASS: additional price to add to the HID iCLASS price. Gross price	27,70
---	-------

Model Ex451

SALTO XS4 Electronic Escutcheon Ex451,
2 Handles, any type, inside thumbturn, with connector for mortise lock with micro-switch.

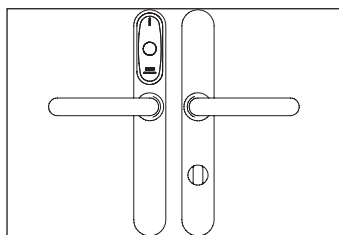

Inside Picopass
LEGIC advant - Prime
Mifare - DESFire
BLE Mifare DESFire
HID iCLASS
BLE HID iCLASS

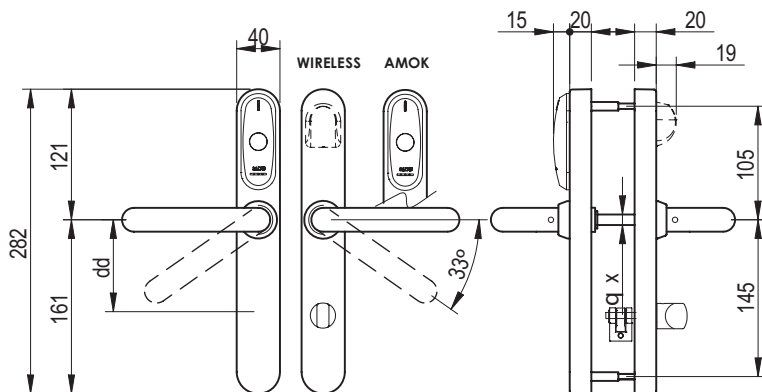

Technology	Escutcheon width	Function	Handle	Handle to thumbturn	Finish	Door thickness	Square spindle	Handing	Wireless option	Gain durability							
E7 PICOPASS	4	51	U	47	IM	3 32-47 mm	7 7mm	-	-								
			L	48				-									
			W	49				-									
E8 LEGIC			4	51	H ²	55	IP ²	4 45-60mm			8 8mm	-					
					I ²	62						R/L ¹					
					S ^{1,2}	70						-					
E9 MIFARE					4	51	B ²	72			PP	6 60-75mm	9 9mm	-	C Convertible		
							P ²	78						R/L ¹			
							O ¹	7F						-			
EB MIFARE BLE							4	51			J	3R	PM	7 75-90mm	S 8mm split	-	W Wireless
											T	4R				-	
	Z	7R							-								
EH HID iCLASS	4	51							G	85	IA	9 90-105mm	V 9mm split	-	A ³ Amok		
									N	88				R/L ¹			
			K ¹	90					-								
EJ BLE HID iCLASS			4	51					2 ²	92	NE ²	1 105-120mm	V 9mm split	-	G Gain durability		
									3 ²	9R				-			
					4 ²	10			-								
					4	51			5 ²	11	BC ² BioCote	1 105-120mm	V 9mm split	-	G Gain durability		
									6 ²	12				-			
							7 ²	13	-								

Additional Prices - Gross prices



¹ For Handed lever handles, only for S, O or K handles.

² This option has an additional price please refer to the handles or finishes chapter.

³ Not available in BLE Mifare DESFire.

Ref	Remarks	€
G	Gain durability	21,30

Model Ex451	SALTO XS4 Electronic Escutcheon Ex451, 2 Handles, any type, inside thumbturn, with connector for mortise lock with micro-switch.
--------------------	--

Prices - Gross prices	€
------------------------------	---



Picopass: Standard - standard square spindles, finishes and handles.	531,55
Picopass: Standard - 9mm square spindle, finishes and handles.	560,20
Picopass: Wireless convertible - standard square spindles, finishes and handles.	570,35
Picopass: Wireless convertible - 9mm square spindle, finishes and handles.	599,15
Picopass: Wireless - standard square spindles, finishes and handles.	668,05
Picopass: Wireless - 9mm square spindle, finishes and handles.	697,00
Picopass: Amok - standard square spindles, finishes and handles.	701,40
Picopass: Amok - 9mm square spindle, finishes and handles.	730,30



Legic: Standard - standard square spindles, finishes and handles.	506,20
Legic: Standard - 9mm square spindle, finishes and handles.	534,95
Legic: Wireless convertible - standard square spindles, finishes and handles.	545,10
Legic: Wireless convertible - 9mm square spindle, finishes and handles.	573,75
Legic: Wireless - standard square spindles, finishes and handles.	642,85
Legic: Wireless - 9mm square spindle, finishes and handles.	671,60
Legic: Amok - standard square spindles, finishes and handles.	631,35
Legic: Amok - 9mm square spindle, finishes and handles.	660,15



Mifare DESFire: Standard - standard square spindles, finishes and handles.	506,20
Mifare DESFire: Standard - 9mm square spindle, finishes and handles.	534,95
Mifare DESFire: Wireless convertible - standard square spindles, finishes and handles.	545,10
Mifare DESFire: Wireless convertible - 9mm square spindle, finishes and handles.	573,75
Mifare DESFire: Wireless - standard square spindles, finishes and handles.	642,85
Mifare DESFire: Wireless - 9mm square spindle, finishes and handles.	671,60
Mifare DESFire: Amok - standard square spindles, finishes and handles.	631,35
Mifare DESFire: Amok - 9mm square spindle, finishes and handles.	660,15



BLE Mifare DESFire: additional price to add to the Mifare DESFire price. Gross price	27,70
---	-------



HID iCLASS: Standard - standard square spindles, finishes and handles.	620,00
HID iCLASS: Standard - 9mm square spindle, finishes and handles.	648,85
HID iCLASS: Wireless convertible - standard square spindles, finishes and handles.	658,85
HID iCLASS: Wireless convertible - 9mm square spindle, finishes and handles.	687,60
HID iCLASS: Wireless - standard square spindles, finishes and handles.	756,70
HID iCLASS: Wireless - 9mm square spindle, finishes and handles.	785,45
HID iCLASS: Amok - standard square spindles, finishes and handles.	901,20
HID iCLASS: Amok - 9mm square spindle, finishes and handles.	930,00



BLE HID iCLASS: additional price to add to the HID iCLASS price. Gross price	27,70
---	-------

Model Ex452

SALTO XS4 Electronic Escutcheon Ex452,
2 Handles, any type, Inside/Outside cylinder cut out.

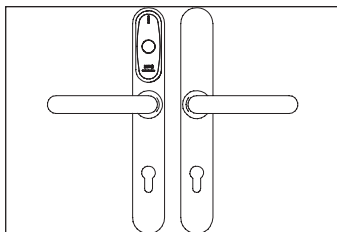

Inside Picopass
LEGIC advant - Prime
Mifare - DESFire
BLE Mifare DESFire
HID iCLASS
BLE HID iCLASS

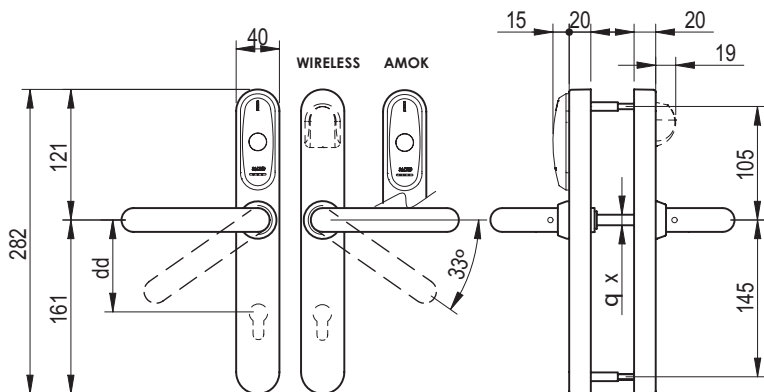

Technology	Escutcheon width	Function	Handle	Handle to thumbturn	Finish	Door thickness	Square spindle	Handing	Wireless option	Gain durability	
E7 PICOPASS	4	52	U	70	IM	3 32-47 mm	7 7mm	-	-		
			L	72				-			
			W					-			
E8 LEGIC			H ²	7F	IP ²	4 45-60mm	8 8mm	-			
			I ²	78				R/L ¹			
			Y ²					-			
E9 MIFARE			B ²	85	PP	6 60-75mm	9 9mm	-			C Convertible
			P ²	88				R/L ¹			
			O ¹	90	-						
EB MIFARE BLE			J	92	PM	7 75-90mm	S 8mm split	-			W Wireless
			T	10	IA			-			
			Z					-			
EH HID iCLASS	G	11	NE ²	9 90-105mm	V 9mm split	R/L ¹	A ³ Amok				
	N	3R				-					
	K ¹	4R				-					
EJ BLE HID iCLASS	2 ²	7R	BC ² BioCote	1 105-120mm		-					
	3 ²	9R				-					
	4 ²					-					
	5 ²										
	7 ²										

Additional Prices - Gross prices



¹ For Handed lever handles, only for S, O or K handles.

² This option has an additional price please refer to the handles or finishes chapter.

³ Not available in BLE Mifare DESFire.

Ref	Remarks	€
G	Gain durability	21,30

Model Ex452

SALTO XS4 Electronic Escutcheon Ex452,
2 Handles, any type, Inside/Outside cylinder cut out.

Prices - Gross prices

€



Picopass: Standard - standard square spindles, finishes and handles.	495,10
Picopass: Standard - 9mm square spindle, finishes and handles.	523,95
Picopass: Wireless convertible - standard square spindles, finishes and handles.	533,95
Picopass: Wireless convertible - 9mm square spindle, finishes and handles.	562,70
Picopass: Wireless - standard square spindles, finishes and handles.	631,70
Picopass: Wireless - 9mm square spindle, finishes and handles.	660,60
Picopass: Amok - standard square spindles, finishes and handles.	665,00
Picopass: Amok - 9mm square spindle, finishes and handles.	693,80



Legic: Standard - standard square spindles, finishes and handles.	471,55
Legic: Standard - 9mm square spindle, finishes and handles.	500,25
Legic: Wireless convertible - standard square spindles, finishes and handles.	510,35
Legic: Wireless convertible - 9mm square spindle, finishes and handles.	539,05
Legic: Wireless - standard square spindles, finishes and handles.	608,10
Legic: Wireless - 9mm square spindle, finishes and handles.	636,85
Legic: Amok - standard square spindles, finishes and handles.	596,65
Legic: Amok - 9mm square spindle, finishes and handles.	625,40

MIFARE DESFire

Mifare DESFire: Standard - standard square spindles, finishes and handles.	471,55
Mifare DESFire: Standard - 9mm square spindle, finishes and handles.	500,25
Mifare DESFire: Wireless convertible - standard square spindles, finishes and handles.	510,35
Mifare DESFire: Wireless convertible - 9mm square spindle, finishes and handles.	539,05
Mifare DESFire: Wireless - standard square spindles, finishes and handles.	608,10
Mifare DESFire: Wireless - 9mm square spindle, finishes and handles.	636,85
Mifare DESFire: Amok - standard square spindles, finishes and handles.	596,65
Mifare DESFire: Amok - 9mm square spindle, finishes and handles.	625,40
BLE Mifare DESFire: additional price to add to the Mifare DESFire price. Gross price	27,70



HID iCLASS: Standard - standard square spindles, finishes and handles.	600,55
HID iCLASS: Standard - 9mm square spindle, finishes and handles.	629,40
HID iCLASS: Wireless convertible - standard square spindles, finishes and handles.	639,40
HID iCLASS: Wireless convertible - 9mm square spindle, finishes and handles.	668,20
HID iCLASS: Wireless - standard square spindles, finishes and handles.	737,20
HID iCLASS: Wireless - 9mm square spindle, finishes and handles.	766,05
HID iCLASS: Amok - standard square spindles, finishes and handles.	881,80
HID iCLASS: Amok - 9mm square spindle, finishes and handles.	910,70
BLE HID iCLASS: additional price to add to the HID iCLASS price. Gross price	27,70



Model Ex453

SALTO XS4 Electronic Escutcheon Ex453,
2 Handles, any type, Inside cylinder cut out.

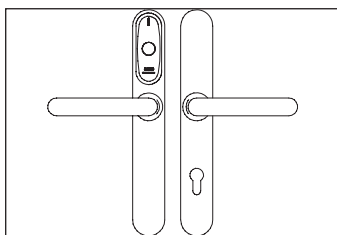

Inside Picopass
LEGIC advant - Prime
Mifare - DESFire
BLE Mifare DESFire
HID iCLASS
BLE HID iCLASS

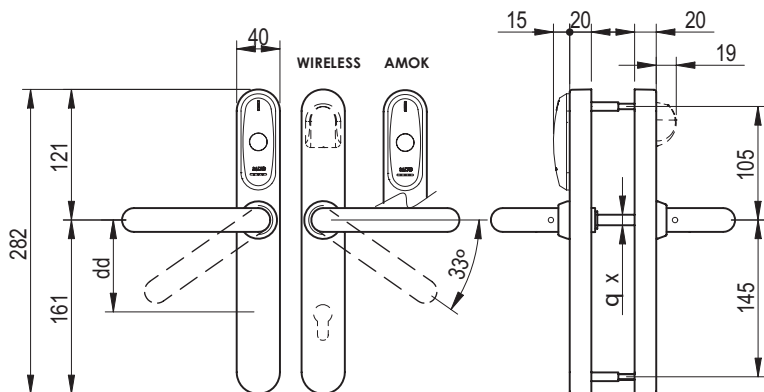

Technology	Escutcheon width	Function	Handle	Handle to thumbturn	Finish	Door thickness	Square spindle	Handing	Wireless option	Gain durability	
E7 PICOPASS	4	53	U	47	IM	2 Fo = 15-17,5mm	7 7mm	-	-		
			L	48				-			
			W	49				-			
E8 LEGIC			H ²	55	IP ²	3 32-47 mm	8 8mm	-			
			I ²	62				-			
			Y ²	70				R/L ¹			
E9 MIFARE			B ²	72	PP	4 45-60mm	9 9mm	-			C Convertible
			P ²	78				R/L ¹			
			O ¹	7F				-			
EB MIFARE BLE			J	3R	PM	5 Fo = 22.5-25mm	S 8mm split	-			W Wireless
			T	4R				-			
	Z	7R	-								
EH HID iCLASS	G	85	IA	6 60-75mm	V 9mm split	R/L ¹	G Gain durability				
	N	88				-					
	K ¹	90				-					
EJ BLE HID iCLASS	2 ²	92	NE ²	7 75-90mm	9 90-105mm Fo = 16.5 -59mm	-	A ³ Amok				
	3 ²	9R				-					
	4 ²	10	BC ² BioCote	1 105-120mm Fo = 30.5 - 89mm	6 7,6mm split	-					
	5 ²	11				-					

Additional Prices - Gross prices



¹ For Handed lever handles, only for S, O or K handles.

² This option has an additional price please refer to the handles or finishes chapter.

³ Not available in BLE Mifare DESFire.

Ref	Remarks	€
G	Gain durability	21,30

Model Ex453

SALTO XS4 Electronic Escutcheon Ex453,
2 Handles, any type, Inside cylinder cut out.

Prices - Gross prices

€



Picopass: Standard - standard square spindles, finishes and handles.	486,15
Picopass: Standard - 9mm square spindle, finishes and handles.	515,00
Picopass: Wireless convertible - standard square spindles, finishes and handles.	525,00
Picopass: Wireless convertible - 9mm square spindle, finishes and handles.	553,80
Picopass: Wireless - standard square spindles, finishes and handles.	622,80
Picopass: Wireless - 9mm square spindle, finishes and handles.	651,75
Picopass: Amok - standard square spindles, finishes and handles.	656,10
Picopass: Amok - 9mm square spindle, finishes and handles.	684,95



Legic: Standard - standard square spindles, finishes and handles.	462,95
Legic: Standard - 9mm square spindle, finishes and handles.	491,90
Legic: Wireless convertible - standard square spindles, finishes and handles.	501,85
Legic: Wireless convertible - 9mm square spindle, finishes and handles.	530,70
Legic: Wireless - standard square spindles, finishes and handles.	599,65
Legic: Wireless - 9mm square spindle, finishes and handles.	628,50
Legic: Amok - standard square spindles, finishes and handles.	588,10
Legic: Amok - 9mm square spindle, finishes and handles.	617,10

MIFARE DESFire

Mifare DESFire: Standard - standard square spindles, finishes and handles.	462,95
Mifare DESFire: Standard - 9mm square spindle, finishes and handles.	491,90
Mifare DESFire: Wireless convertible - standard square spindles, finishes and handles.	501,85
Mifare DESFire: Wireless convertible - 9mm square spindle, finishes and handles.	530,70
Mifare DESFire: Wireless - standard square spindles, finishes and handles.	599,65
Mifare DESFire: Wireless - 9mm square spindle, finishes and handles.	628,50
Mifare DESFire: Amok - standard square spindles, finishes and handles.	588,10
Mifare DESFire: Amok - 9mm square spindle, finishes and handles.	617,10
BLE Mifare DESFire: additional price to add to the Mifare DESFire price. Gross price	27,70



HID iCLASS: Standard - standard square spindles, finishes and handles.	597,35
HID iCLASS: Standard - 9mm square spindle, finishes and handles.	626,20
HID iCLASS: Wireless convertible - standard square spindles, finishes and handles.	636,15
HID iCLASS: Wireless convertible - 9mm square spindle, finishes and handles.	664,95
HID iCLASS: Wireless - standard square spindles, finishes and handles.	734,00
HID iCLASS: Wireless - 9mm square spindle, finishes and handles.	762,75
HID iCLASS: Amok - standard square spindles, finishes and handles.	878,55
HID iCLASS: Amok - 9mm square spindle, finishes and handles.	907,40
BLE HID iCLASS: additional price to add to the HID iCLASS price. Gross price	27,70



Model Ex454

SALTO XS4 Electronic Escutcheon Ex454,
2 Handles, any type, Outside cylinder cut out

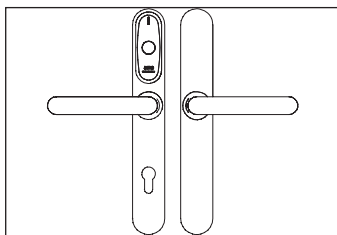

Inside Picopass
LEGIC advant - Prime
Mifare - DESFire
BLE Mifare DESFire
HID iCLASS
BLE HID iCLASS

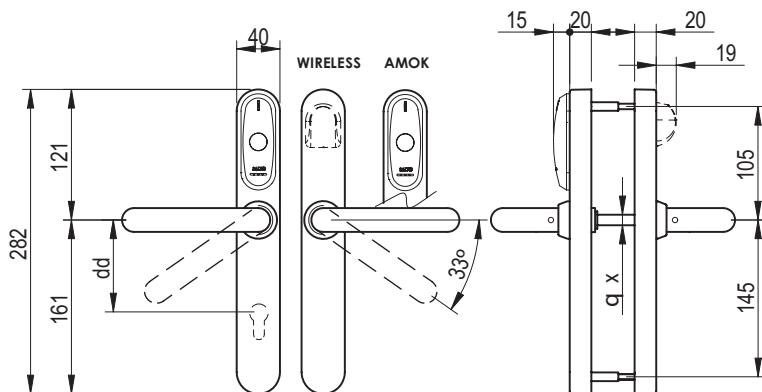

Technology	Escutcheon width	Function	Handle	Handle to thumbturn	Finish	Door thickness	Square spindle	Handing	Wireless option	Gain durability	
E7 PICOPASS	4	54	U	70	IM	2 Fo = 15-17,5mm	7 7mm	-	-		
			L	72				-			
			W					-			
E8 LEGIC			H ²	7F	IP ²	3 32-47 mm	8 8mm	-			
			I ²	78				-			
			Y ²					R/L ¹			
E9 MIFARE			S ^{1,2}	85	PP	4 45-60mm	9 9mm	-			C Convertible
			B ²	88				-			
			P ²					R/L ¹			
EB MIFARE BLE			J	90	PM	B Fo = 20-22,5mm	S 8mm split	-			W Wireless
			T	92				-			
			Z					10			
EH HID iCLASS	G	11	IA	6 60-75mm	V 9mm split	-	G Gain durability				
	N	3R				-					
	K ¹					R/L ¹					
EJ BLE HID iCLASS	2 ²	4R	NE ²	7 75-90mm	9 90-105mm Fo = 16.5 -59mm	-	A ³ Amok				
	3 ²	7R				-					
	4 ²		9R	1 105-120mm Fo = 30.5 - 89mm	-						
	5 ²	-									
7 ²	-										

Additional Prices - Gross prices



¹ For Handed lever handles, only for S, O or K handles.

² This option has an additional price please refer to the handles or finishes chapter.

³ Not available in BLE Mifare DESFire.

Ref	Remarks	€
G	Gain durability	21,30

Model Ex454

SALTO XS4 Electronic Escutcheon Ex454,
2 Handles, any type, Outside cylinder cut out

Prices - Gross prices

€



Picopass: Standard - standard square spindles, finishes and handles.	486,15
Picopass: Standard - 9mm square spindle, finishes and handles.	515,00
Picopass: Wireless convertible - standard square spindles, finishes and handles.	525,00
Picopass: Wireless convertible - 9mm square spindle, finishes and handles.	553,80
Picopass: Wireless - standard square spindles, finishes and handles.	622,80
Picopass: Wireless - 9mm square spindle, finishes and handles.	651,75
Picopass: Amok - standard square spindles, finishes and handles.	656,10
Picopass: Amok - 9mm square spindle, finishes and handles.	684,95



Legic: Standard - standard square spindles, finishes and handles.	462,95
Legic: Standard - 9mm square spindle, finishes and handles.	491,35
Legic: Wireless convertible - standard square spindles, finishes and handles.	501,85
Legic: Wireless convertible - 9mm square spindle, finishes and handles.	530,05
Legic: Wireless - standard square spindles, finishes and handles.	599,65
Legic: Wireless - 9mm square spindle, finishes and handles.	628,00
Legic: Amok - standard square spindles, finishes and handles.	588,10
Legic: Amok - 9mm square spindle, finishes and handles.	616,45

MIFARE DESFire

Mifare DESFire: Standard - standard square spindles, finishes and handles.	462,95
Mifare DESFire: Standard - 9mm square spindle, finishes and handles.	491,35
Mifare DESFire: Wireless convertible - standard square spindles, finishes and handles.	501,85
Mifare DESFire: Wireless convertible - 9mm square spindle, finishes and handles.	530,05
Mifare DESFire: Wireless - standard square spindles, finishes and handles.	599,65
Mifare DESFire: Wireless - 9mm square spindle, finishes and handles.	628,00
Mifare DESFire: Amok - standard square spindles, finishes and handles.	588,10
Mifare DESFire: Amok - 9mm square spindle, finishes and handles.	616,45



BLE Mifare DESFire: additional price to add to the Mifare DESFire price. Gross price	27,70
--	-------



HID iCLASS: Standard - standard square spindles, finishes and handles.	597,35
HID iCLASS: Standard - 9mm square spindle, finishes and handles.	626,20
HID iCLASS: Wireless convertible - standard square spindles, finishes and handles.	636,15
HID iCLASS: Wireless convertible - 9mm square spindle, finishes and handles.	664,95
HID iCLASS: Wireless - standard square spindles, finishes and handles.	734,00
HID iCLASS: Wireless - 9mm square spindle, finishes and handles.	762,75
HID iCLASS: Amok - standard square spindles, finishes and handles.	878,55
HID iCLASS: Amok - 9mm square spindle, finishes and handles.	907,40



BLE HID iCLASS: additional price to add to the HID iCLASS price. Gross price	27,70
--	-------

Model Ex456

SALTO XS4 Electronic Escutcheon Ex456,
2 Handles, any type, Electronic “do not disturb” system.

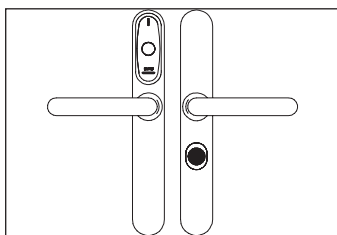

Inside Picopass
LEGIC advant - Prime
Mifare - DESFire
BLE Mifare DESFire
HID iCLASS
BLE HID iCLASS

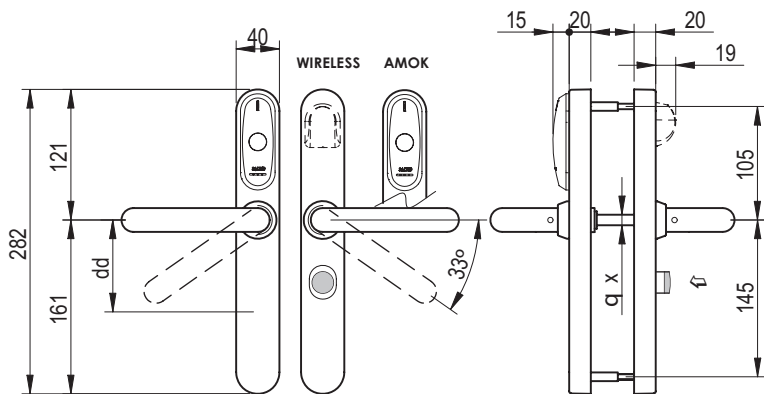

Technology	Escutcheon width	Function	Handle	Handle to thumbturn	Finish	Door thickness	Square spindle	Handing	Wireless option	Gain durability
E7 PICOPASS	4	56	U	00 without distance	IM	2 Fo = 15-17,5mm	7 7mm	-	-	-
			L			-				
			W			-				
E8 LEGIC			H ²		IP ²	3 32-47 mm	-			
			I ²			-				
			Y ²			-				
E9 MIFARE			S ^{1,2}	PP	A Fo = 17.5 -20mm	8 8mm	R/L ¹	C Convertible		
			B ²		-					
			P ²		-					
EB MIFARE BLE			O ¹	PM	B Fo = 20-22,5mm	9 9mm	R/L ¹			
			J		-					
			T		-					
EH HID iCLASS	Z	7F 72mm for fire doors	5 Fo = 22.5-25mm	S 8mm split	-	W Wireless				
	G		-							
	N		-							
EJ BLE HID iCLASS	K ¹		NE ²	6 60-75mm	V 9mm split		R/L ¹	G Gain durability		
	2 ²			-						
	3 ²			-						
	4 ²	BC ² BioCote	7 75-90mm	6 7,6mm split	-	A ³ Amok				
	5 ²		-							
	7 ²		-							
			9 90-105mm Fo = 16.5 -59mm							
			1 105-120mm Fo = 30.5 - 89mm							

Additional Prices - Gross prices



¹ For Handed lever handles, only for S, O or K handles.

² This option has an additional price please refer to the handles or finishes chapter.

³ Not available in BLE Mifare DESFire.

Ref	Remarks	€
G	Gain durability	21,30

Model Ex456

SALTO XS4 Electronic Escutcheon Ex456, 2 Handles, any type, Electronic “do not disturb” system.

Prices - Gross prices

€



Picopass: Standard - standard square spindles, finishes and handles.	516,25
Picopass: Standard - 9mm square spindle, finishes and handles.	545,20
Picopass: Wireless convertible - standard square spindles, finishes and handles.	555,05
Picopass: Wireless convertible - 9mm square spindle, finishes and handles.	583,95
Picopass: Wireless - standard square spindles, finishes and handles.	652,90
Picopass: Wireless - 9mm square spindle, finishes and handles.	681,75
Picopass: Amok - standard square spindles, finishes and handles.	686,40
Picopass: Amok - 9mm square spindle, finishes and handles.	715,15



Legic: Standard - standard square spindles, finishes and handles.	491,75
Legic: Standard - 9mm square spindle, finishes and handles.	520,55
Legic: Wireless convertible - standard square spindles, finishes and handles.	530,50
Legic: Wireless convertible - 9mm square spindle, finishes and handles.	559,45
Legic: Wireless - standard square spindles, finishes and handles.	628,40
Legic: Wireless - 9mm square spindle, finishes and handles.	657,25
Legic: Amok - standard square spindles, finishes and handles.	616,95
Legic: Amok - 9mm square spindle, finishes and handles.	645,70



Mifare DESFire: Standard - standard square spindles, finishes and handles.	491,75
Mifare DESFire: Standard - 9mm square spindle, finishes and handles.	520,55
Mifare DESFire: Wireless convertible - standard square spindles, finishes and handles.	530,50
Mifare DESFire: Wireless convertible - 9mm square spindle, finishes and handles.	559,45
Mifare DESFire: Wireless - standard square spindles, finishes and handles.	628,40
Mifare DESFire: Wireless - 9mm square spindle, finishes and handles.	657,25
Mifare DESFire: Amok - standard square spindles, finishes and handles.	616,95
Mifare DESFire: Amok - 9mm square spindle, finishes and handles.	645,70



BLE Mifare DESFire: additional price to add to the Mifare DESFire price. Gross price	27,70
--	--------------



HID iCLASS: Standard - standard square spindles, finishes and handles.	620,00
HID iCLASS: Standard - 9mm square spindle, finishes and handles.	648,85
HID iCLASS: Wireless convertible - standard square spindles, finishes and handles.	658,85
HID iCLASS: Wireless convertible - 9mm square spindle, finishes and handles.	687,60
HID iCLASS: Wireless - standard square spindles, finishes and handles.	756,70
HID iCLASS: Wireless - 9mm square spindle, finishes and handles.	785,45
HID iCLASS: Amok - standard square spindles, finishes and handles.	901,20
HID iCLASS: Amok - 9mm square spindle, finishes and handles.	930,00



BLE HID iCLASS: additional price to add to the HID iCLASS price. Gross price	27,70
--	--------------

Model Ex457

SALTO XS4 Electronic Escutcheon Ex457,
2 Handles, any type, Outside cylinder cut out, Electronic “do not disturb” system.

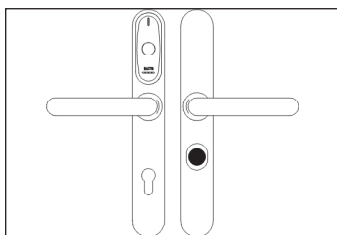

Inside Picopass
LEGIC advant - Prime
Mifare - DESFire
BLE Mifare DESFire
HID iCLASS
BLE HID iCLASS

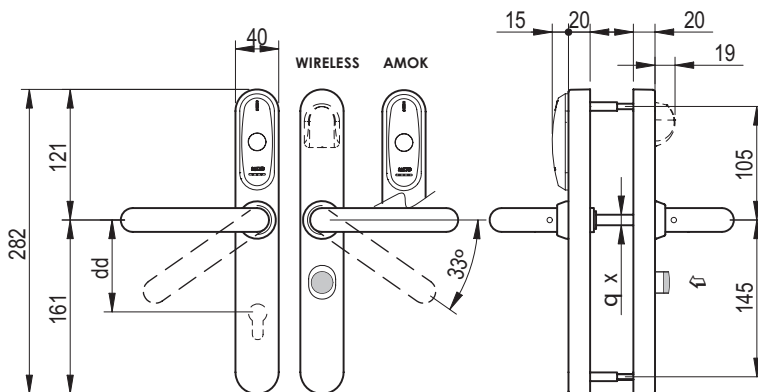

Technology	Escutcheon width	Function	Handle	Handle to thumbturn	Finish	Door thickness	Square spindle	Handing	Wireless option	Gain durability	
E7 PICOPASS	4	57	U	70	IM	2 Fo = 15-17,5mm	7 7mm	-	-		
			L	72				-			
			W					-			
E8 LEGIC			H ²	7F	IP ²	3 32-47 mm	8 8mm	-			
			I ²	78				-			
			Y ²					R/L ¹			
E9 MIFARE			S ^{1,2}	85	PP	4 45-60mm	9 9mm	-			C Convertible
			B ²	88				-			
			P ²					R/L ¹			
EB MIFARE BLE			J	90	PM	B Fo = 20-22,5mm	S 8mm split	-			W Wireless
			T	92				-			
			Z	10				IA			
G	11	-									
EH HID iCLASS	N	3R	NE ²	7 75-90mm	V 9mm split	R/L ¹	G Gain durability				
	K ¹					-					
	2 ²					4R		-			
EJ BLE HID iCLASS	3 ²	7R	BC ² BioCote	9 90-105mm Fo = 16.5 -59mm	6 7,6mm split	-	A ³ Amok				
	4 ²					-					
	5 ²					9R		-			
	7 ²			1 105-120mm Fo = 30.5 - 89mm							

Additional Prices - Gross prices



¹ For Handed lever handles, only for S, O or K handles.

² This option has an additional price please refer to the handles or finishes chapter.

³ Not available in BLE Mifare DESFire.

Ref	Remarks	€
G	Gain durability	21,30

Model Ex457	SALTO XS4 Electronic Escutcheon Ex457, 2 Handles, any type, Outside cylinder cut out, Electronic “do not disturb” system.
--------------------	--

Prices - Gross prices	€
------------------------------	---



Picopass: Standard - standard square spindles, finishes and handles.	516,25
Picopass: Standard - 9mm square spindle, finishes and handles.	545,20
Picopass: Wireless convertible - standard square spindles, finishes and handles.	555,05
Picopass: Wireless convertible - 9mm square spindle, finishes and handles.	583,95
Picopass: Wireless - standard square spindles, finishes and handles.	652,90
Picopass: Wireless - 9mm square spindle, finishes and handles.	681,75
Picopass: Amok - standard square spindles, finishes and handles.	686,40
Picopass: Amok - 9mm square spindle, finishes and handles.	715,15



Legic: Standard - standard square spindles, finishes and handles.	491,75
Legic: Standard - 9mm square spindle, finishes and handles.	520,55
Legic: Wireless convertible - standard square spindles, finishes and handles.	530,50
Legic: Wireless convertible - 9mm square spindle, finishes and handles.	559,45
Legic: Wireless - standard square spindles, finishes and handles.	628,40
Legic: Wireless - 9mm square spindle, finishes and handles.	657,25
Legic: Amok - standard square spindles, finishes and handles.	616,95
Legic: Amok - 9mm square spindle, finishes and handles.	645,70



Mifare DESFire: Standard - standard square spindles, finishes and handles.	491,75
Mifare DESFire: Standard - 9mm square spindle, finishes and handles.	520,55
Mifare DESFire: Wireless convertible - standard square spindles, finishes and handles.	530,50
Mifare DESFire: Wireless convertible - 9mm square spindle, finishes and handles.	559,45
Mifare DESFire: Wireless - standard square spindles, finishes and handles.	628,40
Mifare DESFire: Wireless - 9mm square spindle, finishes and handles.	657,25
Mifare DESFire: Amok - standard square spindles, finishes and handles.	616,95
Mifare DESFire: Amok - 9mm square spindle, finishes and handles.	645,70



BLE Mifare DESFire: additional price to add to the Mifare DESFire price. Gross price	27,70
---	-------



HID iCLASS: Standard - standard square spindles, finishes and handles.	620,00
HID iCLASS: Standard - 9mm square spindle, finishes and handles.	648,85
HID iCLASS: Wireless convertible - standard square spindles, finishes and handles.	658,85
HID iCLASS: Wireless convertible - 9mm square spindle, finishes and handles.	687,60
HID iCLASS: Wireless - standard square spindles, finishes and handles.	756,70
HID iCLASS: Wireless - 9mm square spindle, finishes and handles.	785,45
HID iCLASS: Amok - standard square spindles, finishes and handles.	901,20
HID iCLASS: Amok - 9mm square spindle, finishes and handles.	930,00



BLE HID iCLASS: additional price to add to the HID iCLASS price. Gross price	27,70
---	-------

Model Ex4P0

SALTO XS4 Electronic Escutcheon Ex4P0,
2 Handles, any type, Built in mechanical cylinder with audit housing,
(mechanical cylinder not included, for technical specifications consult SALTO)

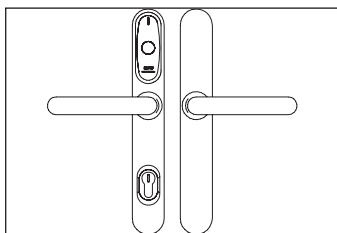

Inside Picopass
LEGIC advant - Prime
Mifare - DESFire
BLE Mifare DESFire
HID iCLASS
BLE HID iCLASS

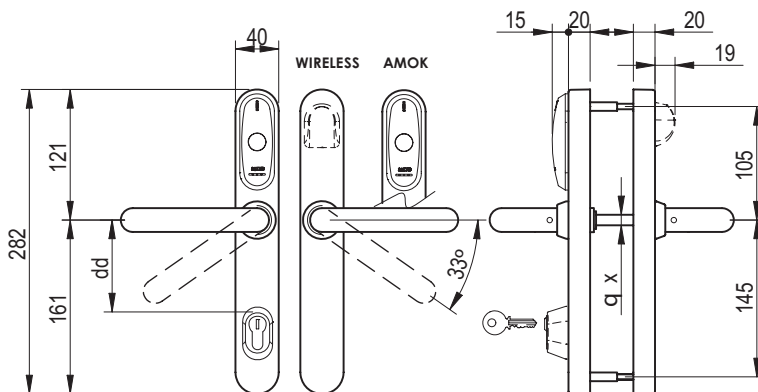

Technology	Escutcheon width	Function	Handle	Handle to thumbturn	Finish	Door thickness	Square spindle	Handing	Wireless option	Gain durability				
E7 PICOPASS	4	PO Euro profile cylinder 30-10	U	00 without distance	IM	2 Fo = 15-17,5mm	7 7mm	-	-	-				
			L					-						
			W					-						
E8 LEGIC			H ²		I ²	Y ²	S ^{1,2}	IP ²			3 32-47 mm	8 8mm	-	
													R/L ¹	
													-	
E9 MIFARE			B ²		P ²	O ¹	PP	4 45-60mm			9 9mm	-	C Convertible	
												R/L ¹		
												-		
EB MIFARE BLE			J		T	Z	G	PM			5 Fo = 22.5-25mm	S 8mm split	-	W Wireless
													-	
													-	
EH HID iCLASS	N	K ¹	2 ²	3 ²	IA	6 60-75mm	V 9mm split	R/L ¹	G Gain durability					
								-						
								-						
EJ BLE HID iCLASS	4 ²	5 ²	7 ²	NE ²	9 90-105mm Fo = 16.5 -59mm	7 75-90mm	6 7,6mm split	-	A ³ Amok					
								-						
								-						
					BC ² BioCote	1 105-120mm Fo = 30.5 - 89mm		-						
								-						
								-						



¹ For Handed lever handles, only for S, O or K handles.

² This option has an additional price please refer to the handles or finishes chapter.

³ Not available in BLE Mifare DESFire.

Cylinders for the override Model P

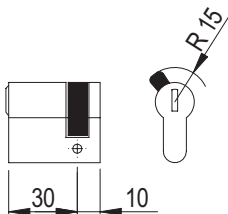

Additional Prices - Gross prices

Ref	Remarks	€
G	Gain durability	21,30

Model Ex4P0

SALTO XS4 Electronic Escutcheon Ex4P0,
2 Handles, any type, Built in mechanical cylinder with audit housing,
(mechanical cylinder not included, for technical specifications consult SALTO)

Prices - Gross prices

€



Picopass: Standard - standard square spindles, finishes and handles.	495,30
Picopass: Standard - 9mm square spindle, finishes and handles.	524,15
Picopass: Wireless convertible - standard square spindles, finishes and handles.	534,25
Picopass: Wireless convertible - 9mm square spindle, finishes and handles.	562,95
Picopass: Wireless - standard square spindles, finishes and handles.	631,95
Picopass: Wireless - 9mm square spindle, finishes and handles.	660,75
Picopass: Amok - standard square spindles, finishes and handles.	665,20
Picopass: Amok - 9mm square spindle, finishes and handles.	694,05



Legic: Standard - standard square spindles, finishes and handles.	472,00
Legic: Standard - 9mm square spindle, finishes and handles.	500,90
Legic: Wireless convertible - standard square spindles, finishes and handles.	510,85
Legic: Wireless convertible - 9mm square spindle, finishes and handles.	539,75
Legic: Wireless - standard square spindles, finishes and handles.	608,65
Legic: Wireless - 9mm square spindle, finishes and handles.	637,65
Legic: Amok - standard square spindles, finishes and handles.	597,15
Legic: Amok - 9mm square spindle, finishes and handles.	626,15

MIFARE DESFire

Mifare DESFire: Standard - standard square spindles, finishes and handles.	472,00
Mifare DESFire: Standard - 9mm square spindle, finishes and handles.	500,90
Mifare DESFire: Wireless convertible - standard square spindles, finishes and handles.	510,85
Mifare DESFire: Wireless convertible - 9mm square spindle, finishes and handles.	539,75
Mifare DESFire: Wireless - standard square spindles, finishes and handles.	608,65
Mifare DESFire: Wireless - 9mm square spindle, finishes and handles.	637,65
Mifare DESFire: Amok - standard square spindles, finishes and handles.	597,15
Mifare DESFire: Amok - 9mm square spindle, finishes and handles.	626,15
BLE Mifare DESFire: additional price to add to the Mifare DESFire price. Gross price	27,70



HID iCLASS: Standard - standard square spindles, finishes and handles.	593,40
HID iCLASS: Standard - 9mm square spindle, finishes and handles.	622,30
HID iCLASS: Wireless convertible - standard square spindles, finishes and handles.	632,30
HID iCLASS: Wireless convertible - 9mm square spindle, finishes and handles.	661,20
HID iCLASS: Wireless - standard square spindles, finishes and handles.	730,05
HID iCLASS: Wireless - 9mm square spindle, finishes and handles.	758,95
HID iCLASS: Amok - standard square spindles, finishes and handles.	874,60
HID iCLASS: Amok - 9mm square spindle, finishes and handles.	903,50
BLE HID iCLASS: additional price to add to the HID iCLASS price. Gross price	27,70



Model Ex4P1

SALTO XS4 Electronic Escutcheon Ex4P1, 2 Handles, any type, Inside thumbturn, built in mechanical cylinder with audit housing, (mechanical cylinder not included, for technical specifications consult SALTO).

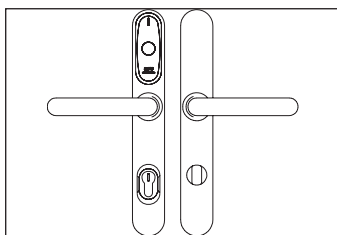

Inside Picopass
LEGIC advant - Prime
Mifare - DESFire
BLE Mifare DESFire
HID iCLASS
BLE HID iCLASS

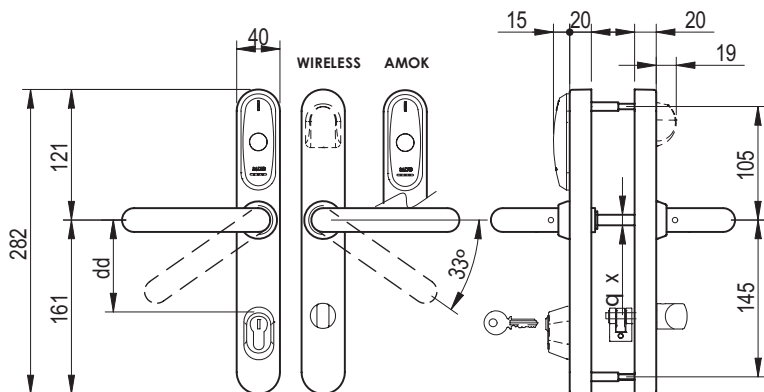

Technology	Escutcheon width	Function	Handle	Handle to thumbturn	Finish	Door thickness	Square spindle	Handing	Wireless option	Gain durability								
E7 PICOPASS	4	P1 Euro profile cylinder 30-10	U	47	IM	3 32-47 mm	7 7mm	-	-									
			L	48				-										
			W	49				-										
E8 LEGIC			4	P1 Euro profile cylinder 30-10	H ²	55	IP ²	4 45-60mm			8 8mm	-						
					I ²	62						R/L ¹						
					S ^{1,2}	70						-						
E9 MIFARE					4	P1 Euro profile cylinder 30-10	B ²	72			PP	6 60-75mm	9 9mm	-	C Convertible			
							P ²	78						R/L ¹				
							O ¹	3R						-				
EB MIFARE BLE							4	P1 Euro profile cylinder 30-10			J	4R	PM	7 75-90mm		S 8mm split	-	W Wireless
											T	7R					-	
											Z	85					-	
EH HID iCLASS	4	P1 Euro profile cylinder 30-10							G	88	IA	9 90-105mm	V 9mm split	R/L ¹	G Gain durability			
									N	90				-				
									K ¹	92				-				
EJ BLE HID iCLASS			4	P1 Euro profile cylinder 30-10					2 ²	9R	NE ²	1 105-120mm	V 9mm split	-		A ³ Amok		
									3 ²	10				-				
									4 ²	11				-				
					5 ²													
									7 ²									



¹ For Handed lever handles, only for S, O or K handles.

² This option has an additional price please refer to the handles or finishes chapter.

³ Not available in BLE Mifare DESFire.

Cylinders for the override Model P

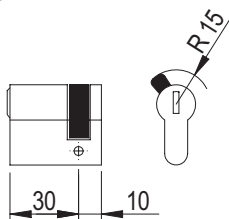

Additional Prices - Gross prices

Ref	Remarks	€
G	Gain durability	21,30

Model Ex4P1

SALTO XS4 Electronic Escutcheon Ex4P1, 2 Handles, any type, Inside thumbturn, built in mechanical cylinder with audit housing, (mechanical cylinder not included, for technical specifications consult SALTO).

Prices - Gross prices

€



Picopass: Standard - standard square spindles, finishes and handles.	538,80
Picopass: Standard - 9mm square spindle, finishes and handles.	567,65
Picopass: Wireless convertible - standard square spindles, finishes and handles.	577,60
Picopass: Wireless convertible - 9mm square spindle, finishes and handles.	606,45
Picopass: Wireless - standard square spindles, finishes and handles.	675,55
Picopass: Wireless - 9mm square spindle, finishes and handles.	704,25
Picopass: Amok - standard square spindles, finishes and handles.	708,80
Picopass: Amok - 9mm square spindle, finishes and handles.	737,65



Legic: Standard - standard square spindles, finishes and handles.	513,45
Legic: Standard - 9mm square spindle, finishes and handles.	542,30
Legic: Wireless convertible - standard square spindles, finishes and handles.	552,30
Legic: Wireless convertible - 9mm square spindle, finishes and handles.	581,25
Legic: Wireless - standard square spindles, finishes and handles.	650,10
Legic: Wireless - 9mm square spindle, finishes and handles.	678,90
Legic: Amok - standard square spindles, finishes and handles.	638,60
Legic: Amok - 9mm square spindle, finishes and handles.	667,45

MIFARE DESFire

Mifare DESFire: Standard - standard square spindles, finishes and handles.	513,45
Mifare DESFire: Standard - 9mm square spindle, finishes and handles.	542,30
Mifare DESFire: Wireless convertible - standard square spindles, finishes and handles.	552,30
Mifare DESFire: Wireless convertible - 9mm square spindle, finishes and handles.	581,25
Mifare DESFire: Wireless - standard square spindles, finishes and handles.	650,10
Mifare DESFire: Wireless - 9mm square spindle, finishes and handles.	678,90
Mifare DESFire: Amok - standard square spindles, finishes and handles.	638,60
Mifare DESFire: Amok - 9mm square spindle, finishes and handles.	667,45
BLE Mifare DESFire: additional price to add to the Mifare DESFire price. Gross price	27,70



HID iCLASS: Standard - standard square spindles, finishes and handles.	627,20
HID iCLASS: Standard - 9mm square spindle, finishes and handles.	656,10
HID iCLASS: Wireless convertible - standard square spindles, finishes and handles.	666,20
HID iCLASS: Wireless convertible - 9mm square spindle, finishes and handles.	695,05
HID iCLASS: Wireless - standard square spindles, finishes and handles.	763,95
HID iCLASS: Wireless - 9mm square spindle, finishes and handles.	792,75
HID iCLASS: Amok - standard square spindles, finishes and handles.	908,45
HID iCLASS: Amok - 9mm square spindle, finishes and handles.	937,45
BLE HID iCLASS: additional price to add to the HID iCLASS price. Gross price	27,70



Model Ex4P6

SALTO XS4 Electronic Escutcheon Ex4P6,
2 Handles, any type, electronic “do not disturb” system, built in mechanical cylinder with audit housing, (mechanical cylinder not included, for technical specifications consult SALTO).

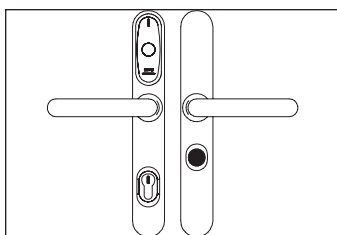

Inside Picopass
LEGIC advant - Prime
Mifare - DESFire
BLE Mifare DESFire
HID iCLASS
BLE HID iCLASS

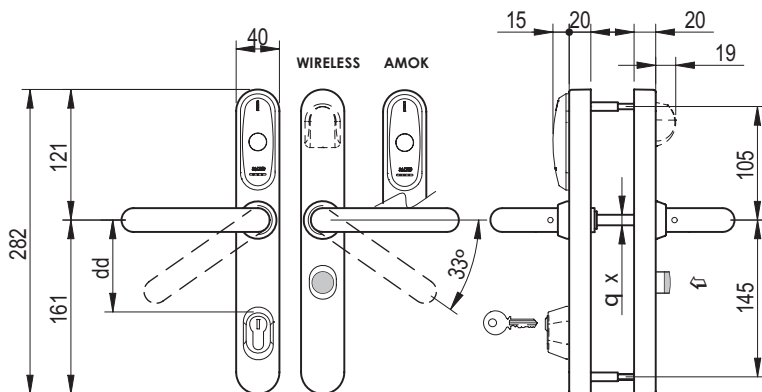

Technology	Escutcheon width	Function	Handle	Handle to thumbturn	Finish	Door thickness	Square spindle	Handing	Wireless option	Gain durability		
E7 PICOPASS	4	P6 Euro profile cylinder 30-10	U	00 without distance	IM	2 Fo = 15-17,5mm	7 7mm	-	-	-		
			L			-						
			W			-						
E8 LEGIC			H ²		I ²	IP ²	3 32-47 mm	8 8mm			-	
							Y ²				-	
							S ^{1,2}				R/L ¹	
E9 MIFARE			B ²		P ²	PP	4 45-60mm	9 9mm			-	C Convertible
							O ¹				R/L ¹	
							J				-	
EB MIFARE BLE			T		Z	IA	5 Fo = 22.5-25mm	S 8mm split			-	W Wireless
							G				-	
							N				-	
EH HID iCLASS	K ¹	2 ²	NE ²	6 60-75mm	V 9mm split	R/L ¹	G Gain durability					
				3 ²		-						
				9 90-105mm Fo = 16.5 -59mm		-						
EJ BLE HID iCLASS	4 ²	5 ²	BC ² BioCote	7 75-90mm	6 7,6mm split	-	A ³ Amok					
				1 105-120mm Fo = 30.5 - 89mm		-						
				7 ²		-						



¹ For Handed lever handles, only for S, O or K handles.

² This option has an additional price please refer to the handles or finishes chapter.

³ Not available in BLE Mifare DESFire.

Cylinders for the override Model P

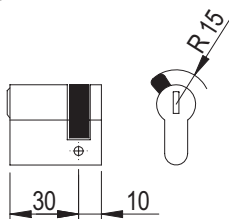

Additional Prices - Gross prices

Ref	Remarks	€
G	Gain durability	21,30

Model Ex4P6

SALTO XS4 Electronic Escutcheon Ex4P6, 2 Handles, any type, electronic “do not disturb” system, built in mechanical cylinder with audit housing, (mechanical cylinder not included, for technical specifications consult SALTO).

Prices - Gross prices

€



Picopass: Standard - standard square spindles, finishes and handles.	523,65
Picopass: Standard - 9mm square spindle, finishes and handles.	552,55
Picopass: Wireless convertible - standard square spindles, finishes and handles.	562,45
Picopass: Wireless convertible - 9mm square spindle, finishes and handles.	591,30
Picopass: Wireless - standard square spindles, finishes and handles.	660,30
Picopass: Wireless - 9mm square spindle, finishes and handles.	689,25
Picopass: Amok - standard square spindles, finishes and handles.	693,50
Picopass: Amok - 9mm square spindle, finishes and handles.	722,50



Legic: Standard - standard square spindles, finishes and handles.	499,00
Legic: Standard - 9mm square spindle, finishes and handles.	527,75
Legic: Wireless convertible - standard square spindles, finishes and handles.	537,90
Legic: Wireless convertible - 9mm square spindle, finishes and handles.	566,85
Legic: Wireless - standard square spindles, finishes and handles.	635,65
Legic: Wireless - 9mm square spindle, finishes and handles.	664,45
Legic: Amok - standard square spindles, finishes and handles.	624,15
Legic: Amok - 9mm square spindle, finishes and handles.	653,00

MIFARE DESFire

Mifare DESFire: Standard - standard square spindles, finishes and handles.	499,00
Mifare DESFire: Standard - 9mm square spindle, finishes and handles.	527,75
Mifare DESFire: Wireless convertible - standard square spindles, finishes and handles.	537,90
Mifare DESFire: Wireless convertible - 9mm square spindle, finishes and handles.	566,85
Mifare DESFire: Wireless - standard square spindles, finishes and handles.	635,65
Mifare DESFire: Wireless - 9mm square spindle, finishes and handles.	664,45
Mifare DESFire: Amok - standard square spindles, finishes and handles.	624,15
Mifare DESFire: Amok - 9mm square spindle, finishes and handles.	653,00



BLE Mifare DESFire: additional price to add to the Mifare DESFire price. Gross price	27,70
--	-------



HID iCLASS: Standard - standard square spindles, finishes and handles.	627,20
HID iCLASS: Standard - 9mm square spindle, finishes and handles.	656,10
HID iCLASS: Wireless convertible - standard square spindles, finishes and handles.	666,20
HID iCLASS: Wireless convertible - 9mm square spindle, finishes and handles.	695,05
HID iCLASS: Wireless - standard square spindles, finishes and handles.	763,95
HID iCLASS: Wireless - 9mm square spindle, finishes and handles.	792,75
HID iCLASS: Amok - standard square spindles, finishes and handles.	908,45
HID iCLASS: Amok - 9mm square spindle, finishes and handles.	937,45



BLE HID iCLASS: additional price to add to the HID iCLASS price. Gross price	27,70
--	-------

Model Ex4K0

SALTO XS4 Electronic Escutcheon Ex4K0,
1 Handle, any type, knob on the inside, SKG** compliant.
(Must be fitted in combination with an automatic deadbolt through mortise lock)

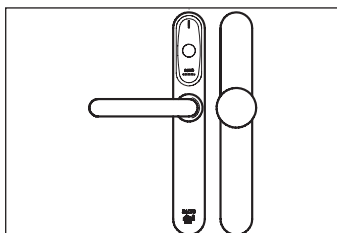

Inside Picopass
LEGIC advant - Prime
Mifare - DESFire
BLE Mifare DESFire
HID iCLASS
BLE HID iCLASS

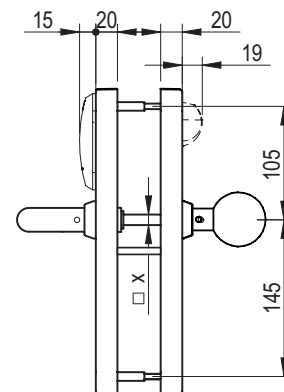
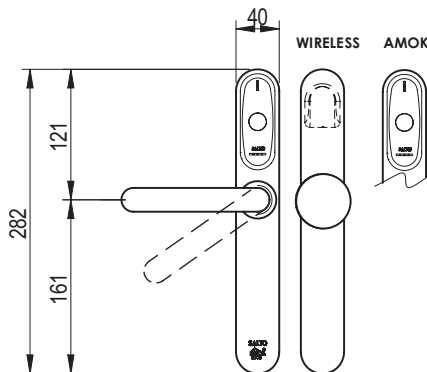

Technology	Escutcheon width	Function	Handle	Handle to thumbturn	Finish	Door thickness	Square spindle	Handing	Wireless option	Gain durability	
E7 PICOPASS	4	K0	U	00 without distance	IM	3 32-47 mm	8 8mm	-	-	Gain durability included by default	
			L					-			
			W					-			
E8 LEGIC			H ²		IP ²	4 45-60mm		-			
			I ²					-			
			Y ²					R/L ¹			
E9 MIFARE			B ²		PP	6 60-75mm		-			C Convertible
			P ²					R/L ¹			
			O ¹					-			
EB MIFARE BLE			J		PM	7 75-90mm		-			W Wireless
			T					-			
			Z					-			
EH HID iCLASS	G	IA	9 90-105mm	-	A ³ Amok						
	N			R/L ¹							
	K ¹			-							
EJ BLE HID iCLASS	2 ²	NE ²	1 105-120mm	-							
	3 ²			-							
	4 ²			-							
	5 ²	BC ² BioCote		-							
	7 ²			-							



¹ For Handed lever handles, only for S, O or K handles.

² This option has an additional price please refer to the handles or finishes chapter.

³ Not available in BLE Mifare DESFire.

Automatic

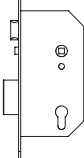

**SKG



Model Ex4K0

SALTO XS4 Electronic Escutcheon Ex4K0,
1 Handle, any type, knob on the inside, SKG** compliant.
(Must be fitted in combination with an automatic deadbolt through mortise lock)

Prices - Gross prices

€



Picopass: Standard - standard square spindles, finishes and handles.

575,40

Picopass: Wireless convertible - standard square spindles, finishes and handles.

614,20

Picopass: Wireless - standard square spindles, finishes and handles.

711,95

Picopass: Amok - standard square spindles, finishes and handles.

745,35



Legic: Standard - standard square spindles, finishes and handles.

552,10

Legic: Wireless convertible - standard square spindles, finishes and handles.

590,90

Legic: Wireless - standard square spindles, finishes and handles.

688,85

Legic: Amok - standard square spindles, finishes and handles.

677,25



Mifare DESFire: Standard - standard square spindles, finishes and handles.

552,10

Mifare DESFire: Wireless convertible - standard square spindles, finishes and handles.

590,90

Mifare DESFire: Wireless - standard square spindles, finishes and handles.

688,85

Mifare DESFire: Amok - standard square spindles, finishes and handles.

677,25



BLE Mifare DESFire: additional price to add to the Mifare DESFire price. **Gross price**

27,70



HID iCLASS: Standard - standard square spindles, finishes and handles.

673,45

HID iCLASS: Wireless convertible - standard square spindles, finishes and handles.

712,35

HID iCLASS: Wireless - standard square spindles, finishes and handles.

810,05

HID iCLASS: Amok - standard square spindles, finishes and handles.

954,70



BLE HID iCLASS: additional price to add to the HID iCLASS price. **Gross price**

27,70

Model Ex4K2

SALTO XS4 Electronic Escutcheon Ex4K2,
2 Handles, any type, Inside/Outside cylinder cut out, SKG** compliant.
(Must be fitted in combination with an SKG** antipanic mortise lock and mechanical cylinder)

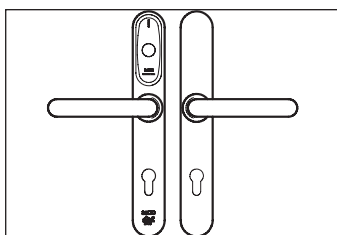

Inside Picopass
LEGIC advant - Prime
Mifare - DESFire
BLE Mifare DESFire
HID iCLASS
BLE HID iCLASS

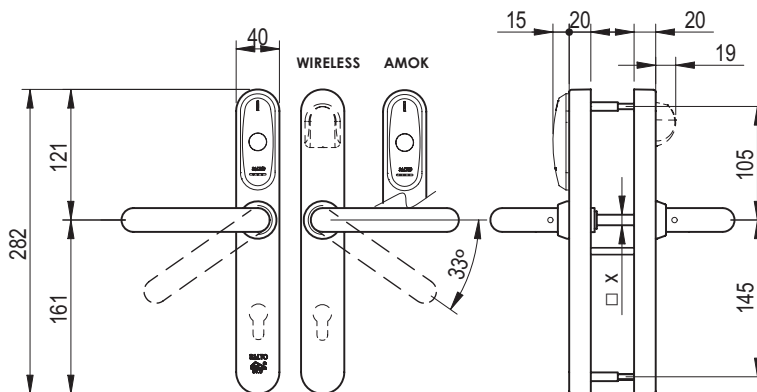

Technology	Escutcheon width	Function	Handle	Handle to thumbturn	Finish	Door thickness	Square spindle	Handing	Wireless option	Gain durability
E7 PICOPASS	4	K2	U	72	IM	3 32-47mm	8 8mm	-	-	Gain durability included by default
			L					-		
			W					-		
E8 LEGIC			H ²		IP ²	4 45-60mm		-		
			I ²					-		
			Y ²					-		
E9 MIFARE			S ^{1,2}	PP	6 60-75mm	R/L ¹	C Convertible			
			B ²			-				
			P ²			R/L ¹				
EB MIFARE BLE			O ¹	PM	7 75-90mm	-	W Wireless			
			J			-				
			T			-				
EH HID iCLASS	Z	IA	9 90-105mm	-	A ³ Amok					
	G			-						
	N			-						
EJ BLE HID iCLASS	K ¹	NE ²	1 105-120mm	R/L ¹	-					
	2 ²			-						
	3 ²			-						
	4 ²			-						
	5 ²	BC ² BioCote		-	-					
	7 ²			-						
				-						
				-						



¹ For Handed lever handles, only for S, O or K handles.

² This option has an additional price please refer to the handles or finishes chapter.

³ Not available in BLE Mifare DESFire.

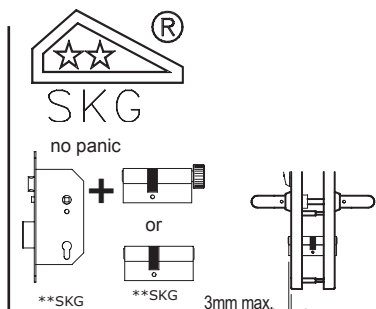

Model Ex4K2

SALTO XS4 Electronic Escutcheon Ex4K2,
2 Handles, any type, Inside/Outside cylinder cut out, SKG** compliant.
(Must be fitted in combination with an SKG** antipanic mortise lock and mechanical cylinder)

Prices - Gross prices

€



Picopass: Standard - standard square spindles, finishes and handles.	582,45
Picopass: Standard - 9mm square spindle, finishes and handles.	611,35
Picopass: Wireless convertible - standard square spindles, finishes and handles.	621,20
Picopass: Wireless convertible - 9mm square spindle, finishes and handles.	650,05
Picopass: Wireless - standard square spindles, finishes and handles.	719,15
Picopass: Wireless - 9mm square spindle, finishes and handles.	747,95
Picopass: Amok - standard square spindles, finishes and handles.	752,45
Picopass: Amok - 9mm square spindle, finishes and handles.	781,20



Legic: Standard - standard square spindles, finishes and handles.	558,90
Legic: Standard - 9mm square spindle, finishes and handles.	587,60
Legic: Wireless convertible - standard square spindles, finishes and handles.	597,65
Legic: Wireless convertible - 9mm square spindle, finishes and handles.	626,50
Legic: Wireless - standard square spindles, finishes and handles.	695,45
Legic: Wireless - 9mm square spindle, finishes and handles.	724,25
Legic: Amok - standard square spindles, finishes and handles.	684,00
Legic: Amok - 9mm square spindle, finishes and handles.	712,75



Mifare DESFire: Standard - standard square spindles, finishes and handles.	558,90
Mifare DESFire: Standard - 9mm square spindle, finishes and handles.	587,60
Mifare DESFire: Wireless convertible - standard square spindles, finishes and handles.	597,65
Mifare DESFire: Wireless convertible - 9mm square spindle, finishes and handles.	626,50
Mifare DESFire: Wireless - standard square spindles, finishes and handles.	695,45
Mifare DESFire: Wireless - 9mm square spindle, finishes and handles.	724,25
Mifare DESFire: Amok - standard square spindles, finishes and handles.	684,00
Mifare DESFire: Amok - 9mm square spindle, finishes and handles.	712,75



BLE Mifare DESFire: additional price to add to the Mifare DESFire price. Gross price	27,70
--	--------------



HID iCLASS: Standard - standard square spindles, finishes and handles.	687,80
HID iCLASS: Standard - 9mm square spindle, finishes and handles.	716,80
HID iCLASS: Wireless convertible - standard square spindles, finishes and handles.	726,80
HID iCLASS: Wireless convertible - 9mm square spindle, finishes and handles.	755,55
HID iCLASS: Wireless - standard square spindles, finishes and handles.	824,60
HID iCLASS: Wireless - 9mm square spindle, finishes and handles.	853,40
HID iCLASS: Amok - standard square spindles, finishes and handles.	969,20
HID iCLASS: Amok - 9mm square spindle, finishes and handles.	998,00



BLE HID iCLASS: additional price to add to the HID iCLASS price. Gross price	27,70
--	--------------

Model Ex4K3

SALTO XS4 Electronic Escutcheon Ex4K3,
2 Handles, any type, Inside cylinder cut out, SKG** compliant.
(Must be fitted in combination with an SKG** antipanic mortise lock and mechanical cylinder)

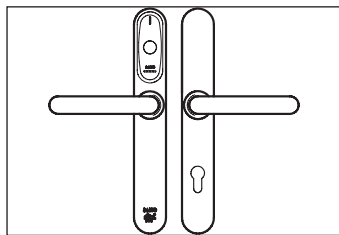

Inside Picopass
LEGIC advant - Prime
Mifare - DESFire
BLE Mifare DESFire
HID iCLASS
BLE HID iCLASS

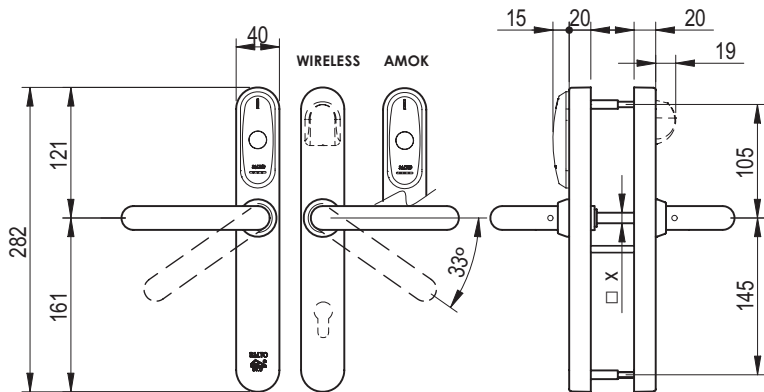

Technology	Escutcheon width	Function	Handle	Handle to thumbturn	Finish	Door thickness	Square spindle	Handing	Wireless option	Gain durability
E7 PICOPASS	4	K3	U	72	IM	3 32-47mm	8 8mm	-	-	Gain durability included by default
			L					-		
			W					-		
E8 LEGIC			H ²		IP ²	4 45-60mm		-		
			I ²					-		
			Y ²					-		
E9 MIFARE			B ²	PP	6 60-75mm	-	9 9mm	R/L ¹	C Convertible	
			P ²			-				
			O ¹			R/L ¹				
EB MIFARE BLE			J	PM	7 75-90mm	-	S 8mm split	-	W Wireless	
			T			-				
			Z			-				
EH HID iCLASS	G	IA	9 90-105mm	-	V 9mm split	R/L ¹	A ³ Amok			
	N			-						
	K ¹			-						
EJ BLE HID iCLASS	2 ²	NE ²	1 105-120mm	-	-	-				
	3 ²			-						
	4 ²			-						
	5 ²			-						
			7 ²		BC ² BioCote					



¹ For Handed lever handles, only for S, O or K handles.

² This option has an additional price please refer to the handles or finishes chapter.

³Not available in BLE Mifare DESFire.

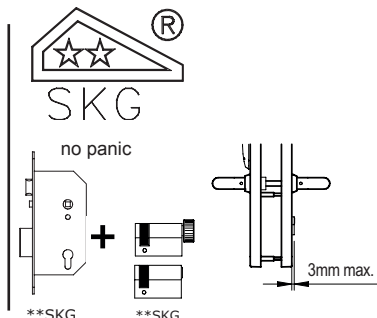

Model Ex4K3

SALTO XS4 Electronic Escutcheon Ex4K3,
2 Handles, any type, Inside cylinder cut out, SKG** compliant.
(Must be fitted in combination with an SKG** antipanic mortise lock and mechanical cylinder)

Prices - Gross prices

€



Picopass: Standard - standard square spindles, finishes and handles.	573,55
Picopass: Standard - 9mm square spindle, finishes and handles.	602,30
Picopass: Wireless convertible - standard square spindles, finishes and handles.	612,40
Picopass: Wireless convertible - 9mm square spindle, finishes and handles.	641,15
Picopass: Wireless - standard square spindles, finishes and handles.	710,15
Picopass: Wireless - 9mm square spindle, finishes and handles.	738,90
Picopass: Amok - standard square spindles, finishes and handles.	743,50
Picopass: Amok - 9mm square spindle, finishes and handles.	772,25



Legic: Standard - standard square spindles, finishes and handles.	550,40
Legic: Standard - 9mm square spindle, finishes and handles.	578,70
Legic: Wireless convertible - standard square spindles, finishes and handles.	589,20
Legic: Wireless convertible - 9mm square spindle, finishes and handles.	617,40
Legic: Wireless - standard square spindles, finishes and handles.	687,00
Legic: Wireless - 9mm square spindle, finishes and handles.	715,30
Legic: Amok - standard square spindles, finishes and handles.	675,55
Legic: Amok - 9mm square spindle, finishes and handles.	703,80

MIFARE DESFire

Mifare DESFire: Standard - standard square spindles, finishes and handles.	550,40
Mifare DESFire: Standard - 9mm square spindle, finishes and handles.	578,70
Mifare DESFire: Wireless convertible - standard square spindles, finishes and handles.	589,20
Mifare DESFire: Wireless convertible - 9mm square spindle, finishes and handles.	617,40
Mifare DESFire: Wireless - standard square spindles, finishes and handles.	687,00
Mifare DESFire: Wireless - 9mm square spindle, finishes and handles.	715,30
Mifare DESFire: Amok - standard square spindles, finishes and handles.	675,55
Mifare DESFire: Amok - 9mm square spindle, finishes and handles.	703,80
BLE Mifare DESFire: additional price to add to the Mifare DESFire price. Gross price	27,70



HID iCLASS: Standard - standard square spindles, finishes and handles.	684,65
HID iCLASS: Standard - 9mm square spindle, finishes and handles.	713,50
HID iCLASS: Wireless convertible - standard square spindles, finishes and handles.	723,50
HID iCLASS: Wireless convertible - 9mm square spindle, finishes and handles.	752,35
HID iCLASS: Wireless - standard square spindles, finishes and handles.	821,35
HID iCLASS: Wireless - 9mm square spindle, finishes and handles.	850,20
HID iCLASS: Amok - standard square spindles, finishes and handles.	966,05
HID iCLASS: Amok - 9mm square spindle, finishes and handles.	994,80
BLE HID iCLASS: additional price to add to the HID iCLASS price. Gross price	27,70



Model Ex4K4

SALTO XS4 Electronic Escutcheon Ex4K4,
2 Handles, any type, Outside cylinder cut out, SKG** compliant.
(Must be fitted in combination with an SKG** antipanic mortise lock and mechanical cylinder)

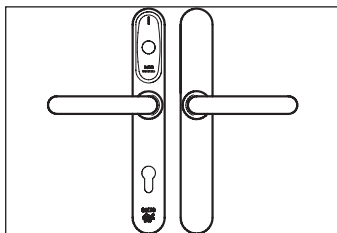

Inside Picopass
LEGIC advant - Prime
Mifare - DESFire
BLE Mifare DESFire
HID iCLASS
BLE HID iCLASS

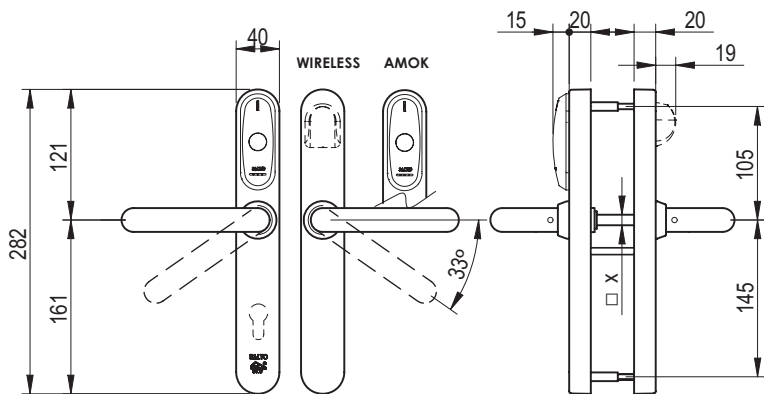

Technology	Escutcheon width	Function	Handle	Handle to thumbturn	Finish	Door thickness	Square spindle	Handing	Wireless option	Gain durability
E7 PICOPASS	4	K4	U	72	IM	3 32-47mm	8 8mm	-	-	Gain durability included by default
			L					-		
			W					-		
E8 LEGIC			H ²		IP ²	4 45-60mm	-			
			I ²				-			
			Y ²				-			
E9 MIFARE			S ^{1,2}	PP	6 60-75mm	R/L ¹	C Convertible			
			B ²			-				
			P ²			R/L ¹				
EB MIFARE BLE			O ¹	PM	7 75-90mm	-	W Wireless			
			J			-				
			T			-				
EH HID iCLASS	Z	IA	9 90-105mm	-	A ³ Amok					
	G			-						
	N			R/L ¹						
EJ BLE HID iCLASS	K ¹	NE ²	1 105-120mm	-						
	2 ²			-						
	3 ²			-						
	4 ²			-						
	5 ²	BC ² BioCote		-						
	7 ²			-						
				-						
				-						



¹ For Handed lever handles, only for S, O or K handles.

² This option has an additional price please refer to the handles or finishes chapter.

³ Not available in BLE Mifare DESFire.

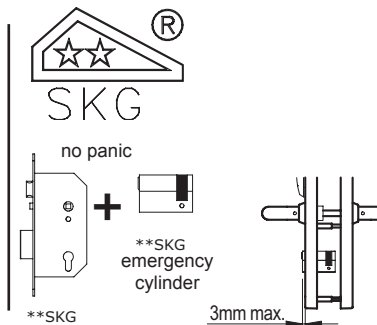

Model Ex4K4

SALTO XS4 Electronic Escutcheon Ex4K4,
2 Handles, any type, Outside cylinder cut out, SKG** compliant.
(Must be fitted in combination with an SKG** antipanic mortise lock and mechanical cylinder)

Prices - Gross prices

€



Picopass: Standard - standard square spindles, finishes and handles.	573,55
Picopass: Standard - 9mm square spindle, finishes and handles.	602,30
Picopass: Wireless convertible - standard square spindles, finishes and handles.	612,40
Picopass: Wireless convertible - 9mm square spindle, finishes and handles.	641,15
Picopass: Wireless - standard square spindles, finishes and handles.	710,15
Picopass: Wireless - 9mm square spindle, finishes and handles.	738,90
Picopass: Amok - standard square spindles, finishes and handles.	743,50
Picopass: Amok - 9mm square spindle, finishes and handles.	772,25



Legic: Standard - standard square spindles, finishes and handles.	550,40
Legic: Standard - 9mm square spindle, finishes and handles.	578,70
Legic: Wireless convertible - standard square spindles, finishes and handles.	589,20
Legic: Wireless convertible - 9mm square spindle, finishes and handles.	617,40
Legic: Wireless - standard square spindles, finishes and handles.	687,00
Legic: Wireless - 9mm square spindle, finishes and handles.	715,30
Legic: Amok - standard square spindles, finishes and handles.	675,55
Legic: Amok - 9mm square spindle, finishes and handles.	703,80

MIFARE DESFire

Mifare DESFire: Standard - standard square spindles, finishes and handles.	550,40
Mifare DESFire: Standard - 9mm square spindle, finishes and handles.	578,70
Mifare DESFire: Wireless convertible - standard square spindles, finishes and handles.	589,20
Mifare DESFire: Wireless convertible - 9mm square spindle, finishes and handles.	617,40
Mifare DESFire: Wireless - standard square spindles, finishes and handles.	687,00
Mifare DESFire: Wireless - 9mm square spindle, finishes and handles.	715,30
Mifare DESFire: Amok - standard square spindles, finishes and handles.	675,55
Mifare DESFire: Amok - 9mm square spindle, finishes and handles.	703,80
BLE Mifare DESFire: additional price to add to the Mifare DESFire price. Gross price	27,70



HID iCLASS: Standard - standard square spindles, finishes and handles.	684,65
HID iCLASS: Standard - 9mm square spindle, finishes and handles.	713,50
HID iCLASS: Wireless convertible - standard square spindles, finishes and handles.	723,50
HID iCLASS: Wireless convertible - 9mm square spindle, finishes and handles.	752,35
HID iCLASS: Wireless - standard square spindles, finishes and handles.	821,35
HID iCLASS: Wireless - 9mm square spindle, finishes and handles.	850,20
HID iCLASS: Amok - standard square spindles, finishes and handles.	966,05
HID iCLASS: Amok - 9mm square spindle, finishes and handles.	994,80
BLE HID iCLASS: additional price to add to the HID iCLASS price. Gross price	27,70



Model Ex550

SALTO XS4 Electronic Escutcheon Ex550,
for DIN fastening holes doors.
2 Handles, any type.

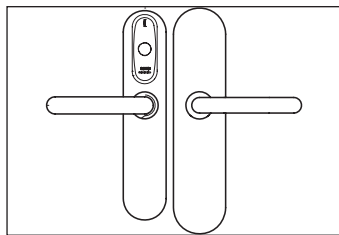

Inside Picopass
LEGIC advant - Prime
Mifare - DESFire
BLE Mifare DESFire
HID iCLASS
BLE HID iCLASS

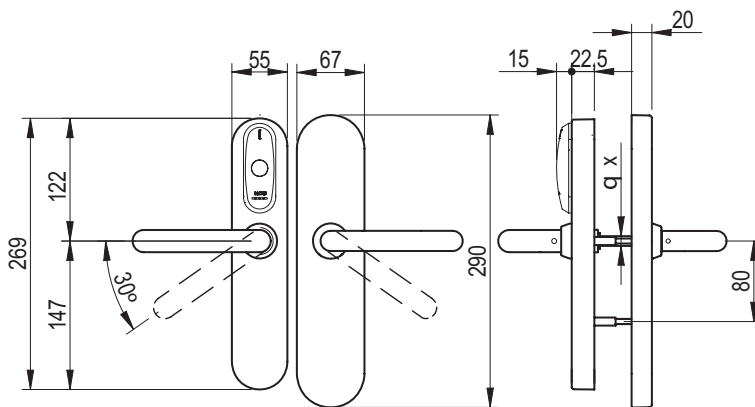

Technology	Escutcheon width	Function	Handle	Handle to thumbturn	Finish	Door thickness	Square spindle	Handing	Wireless option	Gain durability
E7 PICOPASS	5	50	U	RO DIN rose configuration plate	IM	3 32-47 mm	7 7mm	-	-	-
			L					-		
			W					-		
E8 LEGIC			H ²		IP ²	4 45-60mm	-	C Convertible		
			S ^{1,2}				R/L ¹			
			B ²				-			
E9 MIFARE			P ²	6 60-75mm	-	9 9mm	-			
			O ¹		R/L ¹					
			J		-					
EB MIFARE BLE			T	SH DIN short plate configuration plate	7 75-90mm	PM	W Wireless			
			Z					-		
			G					-		
EH HID iCLASS	N	9 90-105mm	S 8mm split		R/L ¹	G Gain durability				
	K ¹				-					
	2 ²				-					
EJ BLE HID iCLASS	3 ²	1 105-120mm	V 9mm split	-	A ³ Amok					
	4 ²			-						
	5 ²			-						
	7 ²			-						



¹ For Handed lever handles, only for S, O or K handles.

² This option has an additional price please refer to the handles or finishes chapter.

³ Not available in BLE Mifare DESFire.

RO door configuration

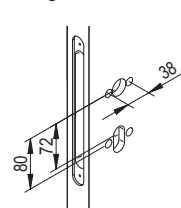

SH door configuration

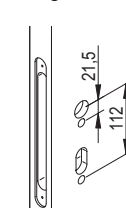

Additional Prices - Gross prices

Ref	Remarks	€
G	Gain durability	21,30

Model Ex550

SALTO XS4 Electronic Escutcheon Ex550,
for DIN fastening holes doors.
2 Handles, any type.

Prices - Gross prices

€



Picopass: Standard - standard square spindles, finishes and handles.	518,50
Picopass: Standard - 9mm square spindle, finishes and handles.	547,50
Picopass: Wireless convertible - standard square spindles, finishes and handles.	557,40
Picopass: Wireless convertible - 9mm square spindle, finishes and handles.	586,25
Picopass: Wireless - standard square spindles, finishes and handles.	655,15
Picopass: Wireless - 9mm square spindle, finishes and handles.	684,15
Picopass: Amok - standard square spindles, finishes and handles.	688,50
Picopass: Amok - 9mm square spindle, finishes and handles.	717,35



Legic: Standard - standard square spindles, finishes and handles.	493,95
Legic: Standard - 9mm square spindle, finishes and handles.	522,75
Legic: Wireless convertible - standard square spindles, finishes and handles.	532,65
Legic: Wireless convertible - 9mm square spindle, finishes and handles.	561,65
Legic: Wireless - standard square spindles, finishes and handles.	630,55
Legic: Wireless - 9mm square spindle, finishes and handles.	659,35
Legic: Amok - standard square spindles, finishes and handles.	619,05
Legic: Amok - 9mm square spindle, finishes and handles.	647,80

MIFARE DESFire

Mifare DESFire: Standard - standard square spindles, finishes and handles.	493,95
Mifare DESFire: Standard - 9mm square spindle, finishes and handles.	522,75
Mifare DESFire: Wireless convertible - standard square spindles, finishes and handles.	532,65
Mifare DESFire: Wireless convertible - 9mm square spindle, finishes and handles.	561,65
Mifare DESFire: Wireless - standard square spindles, finishes and handles.	630,55
Mifare DESFire: Wireless - 9mm square spindle, finishes and handles.	659,35
Mifare DESFire: Amok - standard square spindles, finishes and handles.	619,05
Mifare DESFire: Amok - 9mm square spindle, finishes and handles.	647,80
BLE Mifare DESFire: additional price to add to the Mifare DESFire price. Gross price	27,70



HID iCLASS: Standard - standard square spindles, finishes and handles.	615,35
HID iCLASS: Standard - 9mm square spindle, finishes and handles.	644,10
HID iCLASS: Wireless convertible - standard square spindles, finishes and handles.	654,25
HID iCLASS: Wireless convertible - 9mm square spindle, finishes and handles.	683,05
HID iCLASS: Wireless - standard square spindles, finishes and handles.	751,95
HID iCLASS: Wireless - 9mm square spindle, finishes and handles.	780,75
HID iCLASS: Amok - standard square spindles, finishes and handles.	896,60
HID iCLASS: Amok - 9mm square spindle, finishes and handles.	925,35
BLE HID iCLASS: additional price to add to the HID iCLASS price. Gross price	27,70



Model Ex556

SALTO XS4 Electronic Escutcheon Ex556,
for DIN fastening holes doors.
2 Handles, any type, Electronic "do not disturb" system.

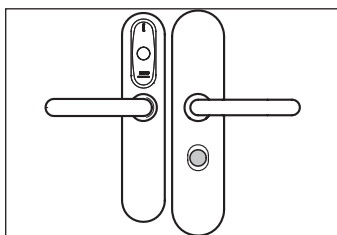

Inside Picopass
LEGIC advant - Prime
Mifare - DESFire
BLE Mifare DESFire
HID iCLASS
BLE HID iCLASS

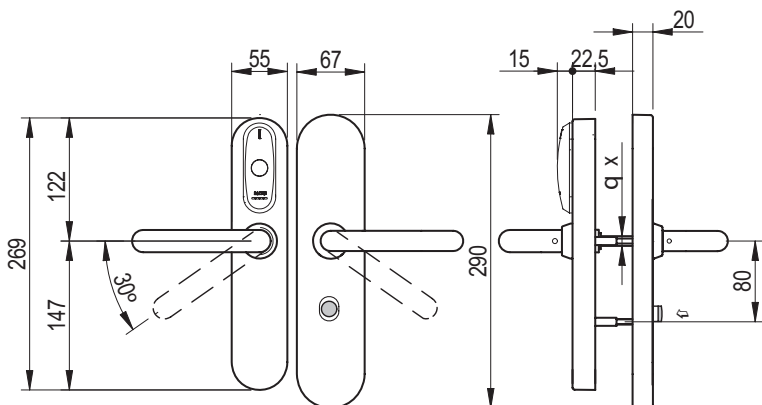

Technology	Escutcheon width	Function	Handle	Handle to thumbturn	Finish	Door thickness	Square spindle	Handing	Wireless option	Gain durability															
E7 PICOPASS	5	56	U	RO DIN rose configuration plate	IM	3 32-47 mm	7 7mm	-	-	-															
			L					-																	
			W					-																	
H ²			-																						
E8 LEGIC			5		56	Y ²	RO DIN rose configuration plate	IP ²			4 45-60mm	8 8mm	-	C Convertible	-										
						S ^{1,2}							R/L ¹												
						B ²							-												
E9 MIFARE						5		56			P ²	RO DIN rose configuration plate	IP ²			6 60-75mm	9 9mm	-	C Convertible	-					
											O ¹							R/L ¹							
											J							-							
EB MIFARE BLE											5		56			T	RO DIN rose configuration plate	PM			7 75-90mm	S	-	W Wireless	G Gain durability
																Z							-		
	G	-																							
EH HID iCLASS	5	56		N					RO DIN rose configuration plate	PM						7 75-90mm		S			-	W Wireless	G Gain durability		
				K ¹																	R/L ¹				
				2 ²																	-				
EJ BLE HID iCLASS			5	56	3 ²		RO DIN rose configuration plate			BC ² BioCote				9 90-105mm	V	-		A ³ Amok			G Gain durability				
					4 ²											-									
					5 ²											-									
					7 ²	-																			



¹ For Handed lever handles, only for S, O or K handles.

² This option has an additional price please refer to the handles or finishes chapter.

³ Not available in BLE Mifare DESFire.

RO door configuration

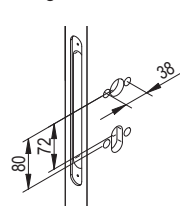

Additional Prices - Gross prices

Ref	Remarks	€
G	Gain durability	21,30

Model Ex556

SALTO XS4 Electronic Escutcheon Ex556,
for DIN fastening holes doors.
2 Handles, any type, Electronic “do not disturb” system.

Prices - Gross prices

€



Picopass: Standard - standard square spindles, finishes and handles.	546,90
Picopass: Standard - 9mm square spindle, finishes and handles.	575,85
Picopass: Wireless convertible - standard square spindles, finishes and handles.	585,85
Picopass: Wireless convertible - 9mm square spindle, finishes and handles.	614,70
Picopass: Wireless - standard square spindles, finishes and handles.	683,65
Picopass: Wireless - 9mm square spindle, finishes and handles.	712,55
Picopass: Amok - standard square spindles, finishes and handles.	717,00
Picopass: Amok - 9mm square spindle, finishes and handles.	745,80



Legic: Standard - standard square spindles, finishes and handles.	520,90
Legic: Standard - 9mm square spindle, finishes and handles.	549,75
Legic: Wireless convertible - standard square spindles, finishes and handles.	559,75
Legic: Wireless convertible - 9mm square spindle, finishes and handles.	588,55
Legic: Wireless - standard square spindles, finishes and handles.	657,55
Legic: Wireless - 9mm square spindle, finishes and handles.	686,45
Legic: Amok - standard square spindles, finishes and handles.	646,10
Legic: Amok - 9mm square spindle, finishes and handles.	674,90

MIFARE DESFire

Mifare DESFire: Standard - standard square spindles, finishes and handles.	520,90
Mifare DESFire: Standard - 9mm square spindle, finishes and handles.	549,75
Mifare DESFire: Wireless convertible - standard square spindles, finishes and handles.	559,75
Mifare DESFire: Wireless convertible - 9mm square spindle, finishes and handles.	588,55
Mifare DESFire: Wireless - standard square spindles, finishes and handles.	657,55
Mifare DESFire: Wireless - 9mm square spindle, finishes and handles.	686,45
Mifare DESFire: Amok - standard square spindles, finishes and handles.	646,10
Mifare DESFire: Amok - 9mm square spindle, finishes and handles.	674,90



BLE Mifare DESFire: additional price to add to the Mifare DESFire price. Gross price	27,70
--	--------------



HID iCLASS: Standard - standard square spindles, finishes and handles.	649,30
HID iCLASS: Standard - 9mm square spindle, finishes and handles.	678,15
HID iCLASS: Wireless convertible - standard square spindles, finishes and handles.	687,85
HID iCLASS: Wireless convertible - 9mm square spindle, finishes and handles.	716,85
HID iCLASS: Wireless - standard square spindles, finishes and handles.	785,85
HID iCLASS: Wireless - 9mm square spindle, finishes and handles.	814,70
HID iCLASS: Amok - standard square spindles, finishes and handles.	930,50
HID iCLASS: Amok - 9mm square spindle, finishes and handles.	959,20



BLE HID iCLASS: additional price to add to the HID iCLASS price. Gross price	27,70
--	--------------

Model Ex5P0

SALTO XS4 Electronic Escutcheon Ex5P0, for DIN fastening holes doors.
2 Handles, any type, built in mechanical cylinder with audit,
(mechanical cylinder not included, for technical specifications consult SALTO).

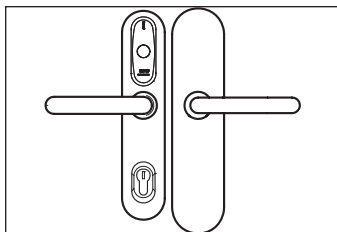

Inside Picopass
LEGIC advant - Prime
Mifare - DESFire
BLE Mifare DESFire
HID iCLASS
BLE HID iCLASS

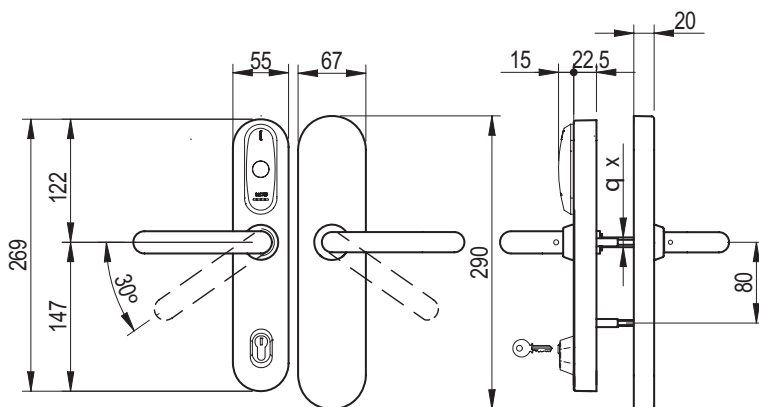

Technology	Escutcheon width	Function	Handle	Handle to thumbturn	Finish	Door thickness	Square spindle	Handing	Wireless option	Gain durability
E7 PICOPASS	5	P0 Euro profile cylinder 30-10	U	RO DIN rose configuration plate	IM	3 32-47 mm	7 7mm	-	-	-
			L					-		
			W					-		
E8 LEGIC			H ²			4 45-60mm		-		
			Y ²					-		
			S ^{1,2}					R/L ¹		
E9 MIFARE			B ²	6 60-75mm	IP ²	-	8 8mm	-	C Convertible	
			P ²			-				
			O ¹			R/L ¹				
EB MIFARE BLE			J	7 75-90mm	SH DIN short plate configuration plate	PM	9 9mm	-	W Wireless	
			T					-		
			Z					-		
EH HID iCLASS	G	9 90-105mm	BC ² BioCote	S		8mm split	-	A ³ Amok		
	N						-			
	K ¹						R/L ¹			
EJ BLE HID iCLASS	2 ²	1 105-120mm	V	9mm split	-	-				
	3 ²				-					
	4 ²				-					
	5 ²				-					
			7 ²							



¹ For Handed lever handles, only for S, O or K handles.

² This option has an additional price please refer to the handles or finishes chapter.

³ Not available in BLE Mifare DESFire.

RO door configuration

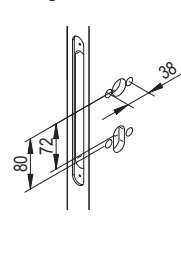

SH door configuration

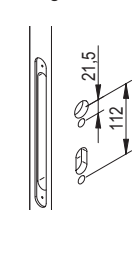

Additional Prices - Gross prices

Ref	Remarks	€
G	Gain durability	21,30

Cylinders for the override Model P

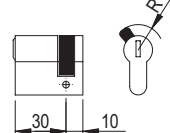

Model Ex5P0

SALTO XS4 Electronic Escutcheon Ex5P0, for DIN fastening holes doors. 2 Handles, any type, built in mechanical cylinder with audit, (mechanical cylinder not included, for technical specifications consult SALTO).

Prices - Gross prices

€



Picopass: Standard - standard square spindles, finishes and handles.	525,95
Picopass: Standard - 9mm square spindle, finishes and handles.	554,75
Picopass: Wireless convertible - standard square spindles, finishes and handles.	564,75
Picopass: Wireless convertible - 9mm square spindle, finishes and handles.	593,55
Picopass: Wireless - standard square spindles, finishes and handles.	662,55
Picopass: Wireless - 9mm square spindle, finishes and handles.	691,45
Picopass: Amok - standard square spindles, finishes and handles.	695,85
Picopass: Amok - 9mm square spindle, finishes and handles.	724,70



Legic: Standard - standard square spindles, finishes and handles.	501,25
Legic: Standard - 9mm square spindle, finishes and handles.	530,05
Legic: Wireless convertible - standard square spindles, finishes and handles.	540,15
Legic: Wireless convertible - 9mm square spindle, finishes and handles.	568,90
Legic: Wireless - standard square spindles, finishes and handles.	637,95
Legic: Wireless - 9mm square spindle, finishes and handles.	666,70
Legic: Amok - standard square spindles, finishes and handles.	626,50
Legic: Amok - 9mm square spindle, finishes and handles.	655,25

MIFARE DESFire

Mifare DESFire: Standard - standard square spindles, finishes and handles.	501,25
Mifare DESFire: Standard - 9mm square spindle, finishes and handles.	530,05
Mifare DESFire: Wireless convertible - standard square spindles, finishes and handles.	540,15
Mifare DESFire: Wireless convertible - 9mm square spindle, finishes and handles.	568,90
Mifare DESFire: Wireless - standard square spindles, finishes and handles.	637,95
Mifare DESFire: Wireless - 9mm square spindle, finishes and handles.	666,70
Mifare DESFire: Amok - standard square spindles, finishes and handles.	626,50
Mifare DESFire: Amok - 9mm square spindle, finishes and handles.	655,25



BLE Mifare DESFire: additional price to add to the Mifare DESFire price. Gross price	27,70
--	--------------



HID iCLASS: Standard - standard square spindles, finishes and handles.	629,70
HID iCLASS: Standard - 9mm square spindle, finishes and handles.	658,55
HID iCLASS: Wireless convertible - standard square spindles, finishes and handles.	668,65
HID iCLASS: Wireless convertible - 9mm square spindle, finishes and handles.	697,50
HID iCLASS: Wireless - standard square spindles, finishes and handles.	766,40
HID iCLASS: Wireless - 9mm square spindle, finishes and handles.	795,20
HID iCLASS: Amok - standard square spindles, finishes and handles.	911,00
HID iCLASS: Amok - 9mm square spindle, finishes and handles.	939,90



BLE HID iCLASS: additional price to add to the HID iCLASS price. Gross price	27,70
--	--------------

Model Ex5P6

SALTO XS4 Electronic Escutcheon Ex5P6, for DIN fastening holes doors. 2 Handles, any type, Electronic "do not disturb" system, built in mechanical cylinder with audit, (mechanical cylinder not included, for technical specifications consult SALTO).

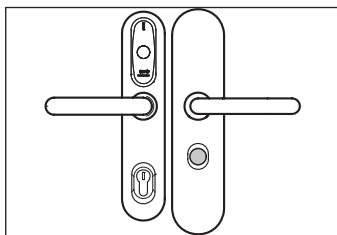

Inside Picopass
LEGIC advant - Prime
Mifare - DESFire
BLE Mifare DESFire
HID iCLASS
BLE HID iCLASS

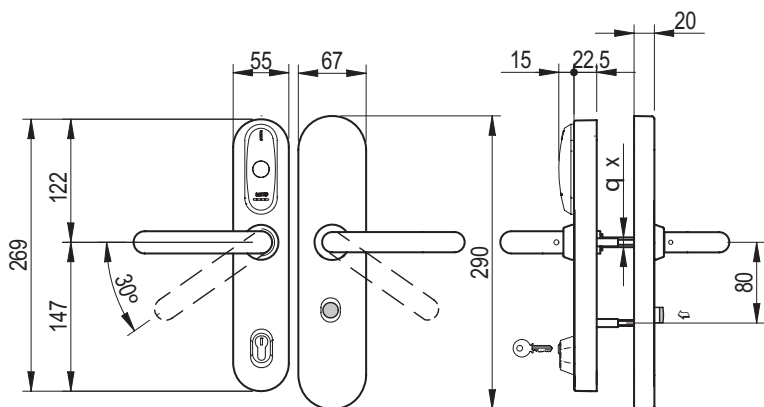

Technology	Escutcheon width	Function	Handle	Handle to thumbturn	Finish	Door thickness	Square spindle	Handing	Wireless option	Gain durability
E7 PICOPASS	5	P6 Euro profile cylinder 30-10	U	RO DIN rose configuration plate	IM	3 32-47 mm	7 7mm	-	-	-
			L					-		
			W					-		
E8 LEGIC			H ²		IP ²	4 45-60mm	-			
			S ^{1,2}				R/L ¹			
			B ²				-			
E9 MIFARE			P ²		6 60-75mm	-				
			O ¹			R/L ¹				
			J			-				
EB MIFARE BLE			T		7 75-90mm	PM	-			
			Z				-			
			G				-			
EH HID iCLASS	N	9 90-105mm	S	-						
	K ¹			R/L ¹						
	2 ²			-						
EJ BLE HID iCLASS	3 ²	1 105-120mm	V	-						
	4 ²			-						
	5 ²			-						
	7 ²			-						



¹ For Handed lever handles, only for S, O or K handles.

² This option has an additional price please refer to the handles or finishes chapter.

³Not available in BLE Mifare DESFire.

RO door configuration

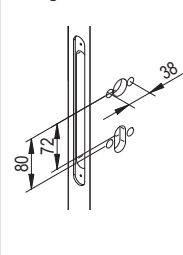

SH door configuration

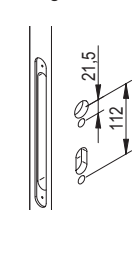

Additional Prices - Gross prices

Ref	Remarks	€
G	Gain durability	21,30

Cylinders for the override Model P

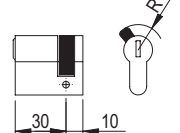

Model Ex5P6

SALTO XS4 Electronic Escutcheon Ex5P6, for DIN fastening holes doors. 2 Handles, any type, Electronic “do not disturb” system, built in mechanical cylinder with audit, (mechanical cylinder not included, for technical specifications consult SALTO).

Prices - Gross prices

€



Picopass: Standard - standard square spindles, finishes and handles.	554,35
Picopass: Standard - 9mm square spindle, finishes and handles.	583,15
Picopass: Wireless convertible - standard square spindles, finishes and handles.	593,15
Picopass: Wireless convertible - 9mm square spindle, finishes and handles.	622,00
Picopass: Wireless - standard square spindles, finishes and handles.	690,85
Picopass: Wireless - 9mm square spindle, finishes and handles.	719,80
Picopass: Amok - standard square spindles, finishes and handles.	724,30
Picopass: Amok - 9mm square spindle, finishes and handles.	753,10



Legic: Standard - standard square spindles, finishes and handles.	528,20
Legic: Standard - 9mm square spindle, finishes and handles.	557,10
Legic: Wireless convertible - standard square spindles, finishes and handles.	567,15
Legic: Wireless convertible - 9mm square spindle, finishes and handles.	595,95
Legic: Wireless - standard square spindles, finishes and handles.	664,80
Legic: Wireless - 9mm square spindle, finishes and handles.	693,65
Legic: Amok - standard square spindles, finishes and handles.	653,25
Legic: Amok - 9mm square spindle, finishes and handles.	682,25

MIFARE DESFire

Mifare DESFire: Standard - standard square spindles, finishes and handles.	528,20
Mifare DESFire: Standard - 9mm square spindle, finishes and handles.	557,10
Mifare DESFire: Wireless convertible - standard square spindles, finishes and handles.	567,15
Mifare DESFire: Wireless convertible - 9mm square spindle, finishes and handles.	595,95
Mifare DESFire: Wireless - standard square spindles, finishes and handles.	664,80
Mifare DESFire: Wireless - 9mm square spindle, finishes and handles.	693,65
Mifare DESFire: Amok - standard square spindles, finishes and handles.	653,25
Mifare DESFire: Amok - 9mm square spindle, finishes and handles.	682,25



BLE Mifare DESFire: additional price to add to the Mifare DESFire price. Gross price	27,70
--	--------------



HID iCLASS: Standard - standard square spindles, finishes and handles.	626,55
HID iCLASS: Standard - 9mm square spindle, finishes and handles.	655,35
HID iCLASS: Wireless convertible - standard square spindles, finishes and handles.	665,40
HID iCLASS: Wireless convertible - 9mm square spindle, finishes and handles.	694,30
HID iCLASS: Wireless - standard square spindles, finishes and handles.	763,15
HID iCLASS: Wireless - 9mm square spindle, finishes and handles.	792,00
HID iCLASS: Amok - standard square spindles, finishes and handles.	907,75
HID iCLASS: Amok - 9mm square spindle, finishes and handles.	936,60



BLE HID iCLASS: additional price to add to the HID iCLASS price. Gross price	27,70
--	--------------

Model Ex650

SALTO XS4 Electronic Escutcheon Ex650,
2 Handles, any type.

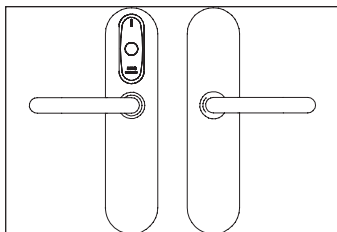

Inside Picopass
LEGIC advant - Prime
Mifare - DESFire
BLE Mifare DESFire
HID iCLASS
BLE HID iCLASS

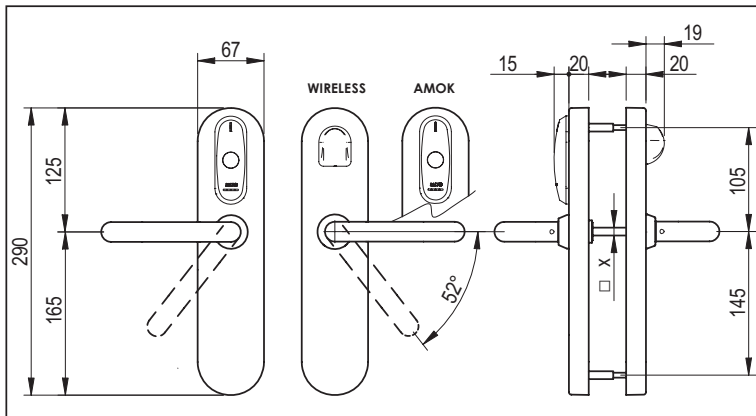

Technology	Escutcheon width	Function	Handle	Handle to thumbturn	Finish	Door thickness	Square spindle	Handing	Wireless option	Gain durability
E7 PICOPASS	6	50	U	00 without distance	IM	2 Fo = 15-17,5mm	7 7mm	-	-	
			L					-		
			W					-		
E8 LEGIC			H ²		IP ²	3 32-47 mm	-			
			Y ²				-			
			S ^{1,2}				-			
E9 MIFARE			B ²	PP	4 45-60mm	-	8 8mm	R/L ¹		
			P ²			-				
			O ¹			-				
EB MIFARE BLE			J	PM	Fo = 20-22,5mm	-	9 9mm	R/L ¹	C Convertible	
			T			-				
			Z			-				
EH HID iCLASS	G	7F 72mm for fire doors	5 Fo = 22.5-25mm	S 8mm split	-	-	W Wireless			
	N				-					
	K ¹				-					
EJ BLE HID iCLASS	2 ²		NE ²	7 75-90mm	V 9mm split	-	R/L ¹	G Gain durability		
	3 ²					-				
	4 ²					-				
	9 90-105mm Fo = 16.5 -59mm	BC ² BioCote	1 105-120mm Fo = 30.5 - 89mm	6 7,6mm split	-	-	A ³ Amok			
	5 ²				-					
	7 ²				-					

Additional Prices - Gross prices



¹ For Handed lever handles, only for S, O or K handles.

² This option has an additional price please refer to the handles or finishes chapter.

³ Not available in BLE Mifare DESFire.

Ref	Remarks	€
G	Gain durability	21,30

Model Ex650	SALTO XS4 Electronic Escutcheon Ex650, 2 Handles, any type.
--------------------	--

Prices - Gross prices	€
------------------------------	---



Picopass: Standard - standard square spindles, finishes and handles.	518,50
Picopass: Standard - 9mm square spindle, finishes and handles.	547,50
Picopass: Wireless convertible - standard square spindles, finishes and handles.	557,40
Picopass: Wireless convertible - 9mm square spindle, finishes and handles.	586,25
Picopass: Wireless - standard square spindles, finishes and handles.	655,15
Picopass: Wireless - 9mm square spindle, finishes and handles.	684,15
Picopass: Amok - standard square spindles, finishes and handles.	688,50
Picopass: Amok - 9mm square spindle, finishes and handles.	717,35



Legic: Standard - standard square spindles, finishes and handles.	493,95
Legic: Standard - 9mm square spindle, finishes and handles.	522,75
Legic: Wireless convertible - standard square spindles, finishes and handles.	532,65
Legic: Wireless convertible - 9mm square spindle, finishes and handles.	561,65
Legic: Wireless - standard square spindles, finishes and handles.	630,55
Legic: Wireless - 9mm square spindle, finishes and handles.	659,35
Legic: Amok - standard square spindles, finishes and handles.	619,05
Legic: Amok - 9mm square spindle, finishes and handles.	647,80



Mifare DESFire: Standard - standard square spindles, finishes and handles.	493,95
Mifare DESFire: Standard - 9mm square spindle, finishes and handles.	522,75
Mifare DESFire: Wireless convertible - standard square spindles, finishes and handles.	532,65
Mifare DESFire: Wireless convertible - 9mm square spindle, finishes and handles.	561,65
Mifare DESFire: Wireless - standard square spindles, finishes and handles.	630,55
Mifare DESFire: Wireless - 9mm square spindle, finishes and handles.	659,35
Mifare DESFire: Amok - standard square spindles, finishes and handles.	619,05
Mifare DESFire: Amok - 9mm square spindle, finishes and handles.	647,80



BLE Mifare DESFire: additional price to add to the Mifare DESFire price. Gross price	27,70
---	-------



HID iCLASS: Standard - standard square spindles, finishes and handles.	615,35
HID iCLASS: Standard - 9mm square spindle, finishes and handles.	644,10
HID iCLASS: Wireless convertible - standard square spindles, finishes and handles.	654,25
HID iCLASS: Wireless convertible - 9mm square spindle, finishes and handles.	683,05
HID iCLASS: Wireless - standard square spindles, finishes and handles.	751,95
HID iCLASS: Wireless - 9mm square spindle, finishes and handles.	780,75
HID iCLASS: Amok - standard square spindles, finishes and handles.	896,60
HID iCLASS: Amok - 9mm square spindle, finishes and handles.	925,35



BLE HID iCLASS: additional price to add to the HID iCLASS price. Gross price	27,70
---	-------

Model Ex651 SALTO XS4 Electronic Escutcheon Ex651, 2 Handles, any type, Inside thumbturn, with connector for mortise lock with micro-switch.

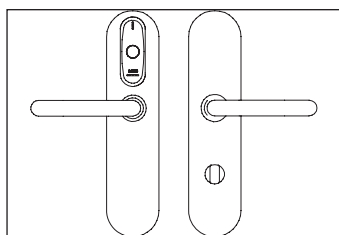

Inside Picopass
LEGIC advant - Prime
Mifare - DESFire
BLE Mifare DESFire
HID iCLASS
BLE HID iCLASS

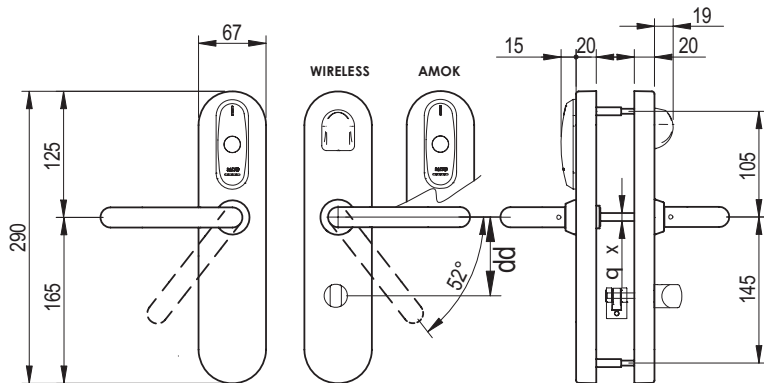

Technology	Escutcheon width	Function	Handle	Handle to thumbturn	Finish	Door thickness	Square spindle	Handing	Wireless option	Gain durability	
E7 PICOPASS	6	51	U	47	IM	3 32-47mm	7 7mm	-	-		
			L	48				-			
			W	49				-			
E8 LEGIC			H ²	55	IP ²	4 45-60mm	8 8mm	-			
			Y ²	62				-			
			S ^{1,2}	70				R/L ¹			
E9 MIFARE			B ²	72	PP	6 60-75mm	9 9mm	-			C Convertible
			P ²	78				-			
			O ¹	7F				R/L ¹			
EB MIFARE BLE			J	3R	PM	7 75-90mm	S	-			W Wireless
			T	4R				-			
	Z	7R	-								
EH HID iCLASS	G	85	IA	9 90-105mm	8mm split	-	G Gain durability				
	N	88				R/L ¹					
	K ¹	90				-					
EJ BLE HID iCLASS	2 ²	92	NE ²	1 105-120mm	V 9mm split	-	A ³ Amok				
	3 ²	92				-					
	4 ²	9R				-					
	5 ²	10	BC ² BioCote			-					
	7 ²	11				-					

Additional Prices - Gross prices



¹ For Handed lever handles, only for S, O or K handles.

² This option has an additional price please refer to the handles or finishes chapter.

³ Not available in BLE Mifare DESFire.

Ref	Remarks	€
G	Gain durability	21,30

Model Ex651

SALTO XS4 Electronic Escutcheon Ex651, 2 Handles, any type, Inside thumbturn, with connector for mortise lock with micro-switch.

Prices - Gross prices

€



Picopass: Standard - standard square spindles, finishes and handles.	562,10
Picopass: Standard - 9mm square spindle, finishes and handles.	590,90
Picopass: Wireless convertible - standard square spindles, finishes and handles.	600,95
Picopass: Wireless convertible - 9mm square spindle, finishes and handles.	629,70
Picopass: Wireless - standard square spindles, finishes and handles.	698,65
Picopass: Wireless - 9mm square spindle, finishes and handles.	727,50
Picopass: Amok - standard square spindles, finishes and handles.	732,00
Picopass: Amok - 9mm square spindle, finishes and handles.	760,95



Legic: Standard - standard square spindles, finishes and handles.	535,35
Legic: Standard - 9mm square spindle, finishes and handles.	564,30
Legic: Wireless convertible - standard square spindles, finishes and handles.	574,20
Legic: Wireless convertible - 9mm square spindle, finishes and handles.	603,05
Legic: Wireless - standard square spindles, finishes and handles.	672,00
Legic: Wireless - 9mm square spindle, finishes and handles.	700,85
Legic: Amok - standard square spindles, finishes and handles.	660,50
Legic: Amok - 9mm square spindle, finishes and handles.	689,40



Mifare DESFire: Standard - standard square spindles, finishes and handles.	535,35
Mifare DESFire: Standard - 9mm square spindle, finishes and handles.	564,30
Mifare DESFire: Wireless convertible - standard square spindles, finishes and handles.	574,20
Mifare DESFire: Wireless convertible - 9mm square spindle, finishes and handles.	603,05
Mifare DESFire: Wireless - standard square spindles, finishes and handles.	672,00
Mifare DESFire: Wireless - 9mm square spindle, finishes and handles.	700,85
Mifare DESFire: Amok - standard square spindles, finishes and handles.	660,50
Mifare DESFire: Amok - 9mm square spindle, finishes and handles.	689,40



BLE Mifare DESFire: additional price to add to the Mifare DESFire price. Gross price	27,70
--	--------------



HID iCLASS: Standard - standard square spindles, finishes and handles.	649,30
HID iCLASS: Standard - 9mm square spindle, finishes and handles.	678,15
HID iCLASS: Wireless convertible - standard square spindles, finishes and handles.	687,85
HID iCLASS: Wireless convertible - 9mm square spindle, finishes and handles.	716,85
HID iCLASS: Wireless - standard square spindles, finishes and handles.	785,85
HID iCLASS: Wireless - 9mm square spindle, finishes and handles.	814,70
HID iCLASS: Amok - standard square spindles, finishes and handles.	930,50
HID iCLASS: Amok - 9mm square spindle, finishes and handles.	884,85



BLE HID iCLASS: additional price to add to the HID iCLASS price. Gross price	27,70
--	--------------

Model Ex652

SALTO XS4 Electronic Escutcheon Ex652,
2 Handles, any type, inside/outside cylinder cut out.

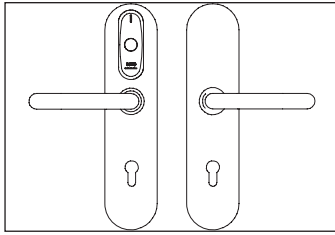

Inside Picopass
LEGIC advant - Prime
Mifare - DESFire
BLE Mifare DESFire
HID iCLASS
BLE HID iCLASS

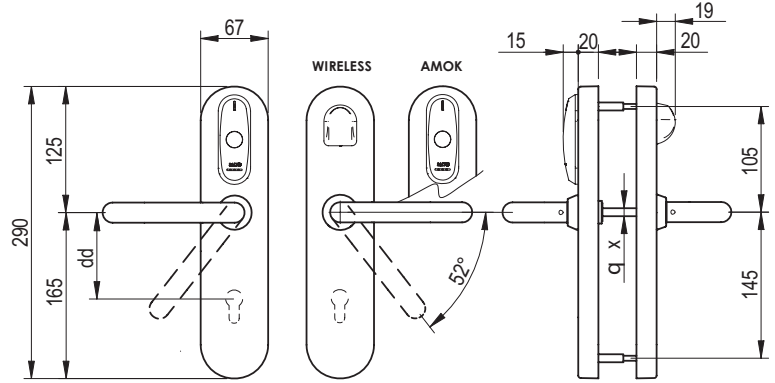

Technology	Escutcheon width	Function	Handle	Handle to thumbturn	Finish	Door thickness	Square spindle	Handing	Wireless option	Gain durability	
E7 PICOPASS	6	52	U	70	IM	2 Fo = 15-17,5mm	7 7mm	-	-		
			L	72				-			
			W					-			
E8 LEGIC			H ²	7F	IP ²	3 32-47 mm	8 8mm	-			
			Y ²	78				-			
			S ^{1,2}					R/L ¹			
E9 MIFARE			B ²	85	PP	4 45-60mm	9 9mm	-			C Convertible
			P ²	88				-			
			O ¹	90				R/L ¹			
EB MIFARE BLE			J	90	PM	5 Fo = 20-22,5mm	S 8mm split	-			W Wireless
			T	92				-			
			Z	10				-			
EH HID iCLASS	G	10	IA	6 60-75mm	V 9mm split	-	G Gain durability				
	N	11				-					
	K ¹	3R				R/L ¹					
EJ BLE HID iCLASS	2 ²	4R	NE ²	7 75-90mm	6 7,6mm split	-	A ³ Amok				
	3 ²	7R				-					
	4 ²	9R				-					
	5 ²		BC ² BioCote	9 90-105mm Fo = 16.5 -59mm		-					
	7 ²	1 105-120mm Fo = 30.5 - 89mm				-					

Additional Prices - Gross prices



¹ For Handed lever handles, only for S, O or K handles.

² This option has an additional price please refer to the handles or finishes chapter.

³ Not available in BLE Mifare DESFire.

Ref	Remarks	€
G	Gain durability	21,30

Model Ex652

SALTO XS4 Electronic Escutcheon Ex652,
2 Handles, any type, inside/outside cylinder cut out.

Prices - Gross prices

€



Picopass: Standard - standard square spindles, finishes and handles.	525,70
Picopass: Standard - 9mm square spindle, finishes and handles.	554,50
Picopass: Wireless convertible - standard square spindles, finishes and handles.	564,60
Picopass: Wireless convertible - 9mm square spindle, finishes and handles.	593,35
Picopass: Wireless - standard square spindles, finishes and handles.	662,30
Picopass: Wireless - 9mm square spindle, finishes and handles.	691,10
Picopass: Amok - standard square spindles, finishes and handles.	695,70
Picopass: Amok - 9mm square spindle, finishes and handles.	724,50



Legic: Standard - standard square spindles, finishes and handles.	500,80
Legic: Standard - 9mm square spindle, finishes and handles.	529,55
Legic: Wireless convertible - standard square spindles, finishes and handles.	539,65
Legic: Wireless convertible - 9mm square spindle, finishes and handles.	568,30
Legic: Wireless - standard square spindles, finishes and handles.	637,45
Legic: Wireless - 9mm square spindle, finishes and handles.	666,20
Legic: Amok - standard square spindles, finishes and handles.	625,90
Legic: Amok - 9mm square spindle, finishes and handles.	654,75

MIFARE DESFire

Mifare DESFire: Standard - standard square spindles, finishes and handles.	500,80
Mifare DESFire: Standard - 9mm square spindle, finishes and handles.	529,55
Mifare DESFire: Wireless convertible - standard square spindles, finishes and handles.	539,65
Mifare DESFire: Wireless convertible - 9mm square spindle, finishes and handles.	568,30
Mifare DESFire: Wireless - standard square spindles, finishes and handles.	637,45
Mifare DESFire: Wireless - 9mm square spindle, finishes and handles.	666,20
Mifare DESFire: Amok - standard square spindles, finishes and handles.	625,90
Mifare DESFire: Amok - 9mm square spindle, finishes and handles.	654,75



BLE Mifare DESFire: additional price to add to the Mifare DESFire price. Gross price	27,70
--	--------------



HID iCLASS: Standard - standard square spindles, finishes and handles.	629,70
HID iCLASS: Standard - 9mm square spindle, finishes and handles.	658,55
HID iCLASS: Wireless convertible - standard square spindles, finishes and handles.	668,65
HID iCLASS: Wireless convertible - 9mm square spindle, finishes and handles.	697,50
HID iCLASS: Wireless - standard square spindles, finishes and handles.	766,40
HID iCLASS: Wireless - 9mm square spindle, finishes and handles.	795,20
HID iCLASS: Amok - standard square spindles, finishes and handles.	911,00
HID iCLASS: Amok - 9mm square spindle, finishes and handles.	939,90



BLE HID iCLASS: additional price to add to the HID iCLASS price. Gross price	27,70
--	--------------

Model Ex653

SALTO XS4 Electronic Escutcheon Ex653,
2 Handles, any type, inside cylinder cut out.

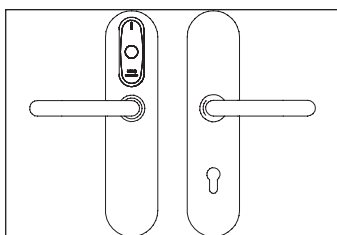

Inside Picopass
LEGIC advant - Prime
Mifare - DESFire
BLE Mifare DESFire
HID iCLASS
BLE HID iCLASS

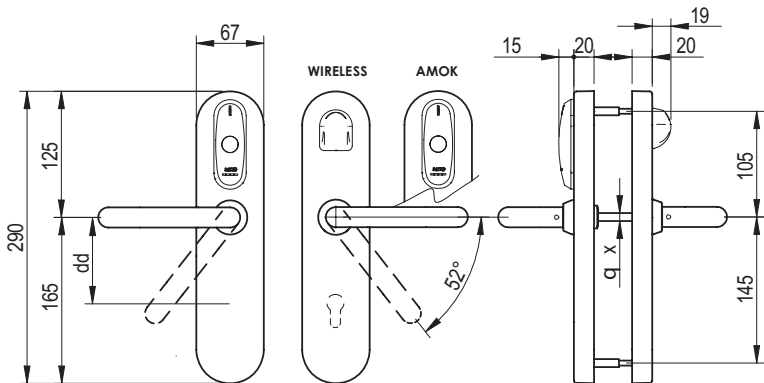

Technology	Escutcheon width	Function	Handle	Handle to thumbturn	Finish	Door thickness	Square spindle	Handing	Wireless option	Gain durability	
E7 PICOPASS	6	53	U	47	IM	2 Fo = 15-17,5mm	7 7mm	-	-		
			L	48				-			
			W	49				-			
E8 LEGIC			H ²	55	IP ²	3 32-47 mm	8 8mm	-			
			Y ²	62				-			
			S ^{1,2}	70				R/L ¹			
E9 MIFARE			B ²	72	PP	4 45-60mm	9 9mm	-			C Convertible
			P ²	78				-			
			O ¹	7F				R/L ¹			
EB MIFARE BLE			J	3R	PM	5 Fo = 20-22,5mm	S 8mm split	-			W Wireless
			T	4R				-			
	Z	7R	-								
EH HID iCLASS	N	85	IA	6 60-75mm	V 9mm split	R/L ¹	G Gain durability				
	K ¹	88				-					
	2 ²	90				-					
EJ BLE HID iCLASS	3 ²	92	NE ²	7 75-90mm	9 90-105mm Fo = 16.5 -59mm	-	A ³ Amok				
	4 ²	9R				-					
	5 ²	10				-					
	7 ²	11	BC ² BioCote	1 105-120mm Fo = 30.5 - 89mm	6 7,6mm split	-					
						-					

Additional Prices - Gross prices



¹ For Handed lever handles, only for S, O or K handles.

² This option has an additional price please refer to the handles or finishes chapter.

³ Not available in BLE Mifare DESFire.

Ref	Remarks	€
G	Gain durability	21,30

Model Ex653

SALTO XS4 Electronic Escutcheon Ex653,
2 Handles, any type, inside cylinder cut out.

Prices - Gross prices

€



Picopass: Standard - standard square spindles, finishes and handles.	517,00
Picopass: Standard - 9mm square spindle, finishes and handles.	545,75
Picopass: Wireless convertible - standard square spindles, finishes and handles.	555,75
Picopass: Wireless convertible - 9mm square spindle, finishes and handles.	584,50
Picopass: Wireless - standard square spindles, finishes and handles.	653,45
Picopass: Wireless - 9mm square spindle, finishes and handles.	682,30
Picopass: Amok - standard square spindles, finishes and handles.	686,85
Picopass: Amok - 9mm square spindle, finishes and handles.	715,60



Legic: Standard - standard square spindles, finishes and handles.	492,20
Legic: Standard - 9mm square spindle, finishes and handles.	521,00
Legic: Wireless convertible - standard square spindles, finishes and handles.	531,05
Legic: Wireless convertible - 9mm square spindle, finishes and handles.	559,85
Legic: Wireless - standard square spindles, finishes and handles.	628,80
Legic: Wireless - 9mm square spindle, finishes and handles.	657,65
Legic: Amok - standard square spindles, finishes and handles.	617,40
Legic: Amok - 9mm square spindle, finishes and handles.	646,25

MIFARE DESFire

Mifare DESFire: Standard - standard square spindles, finishes and handles.	492,20
Mifare DESFire: Standard - 9mm square spindle, finishes and handles.	521,00
Mifare DESFire: Wireless convertible - standard square spindles, finishes and handles.	531,05
Mifare DESFire: Wireless convertible - 9mm square spindle, finishes and handles.	559,85
Mifare DESFire: Wireless - standard square spindles, finishes and handles.	628,80
Mifare DESFire: Wireless - 9mm square spindle, finishes and handles.	657,65
Mifare DESFire: Amok - standard square spindles, finishes and handles.	617,40
Mifare DESFire: Amok - 9mm square spindle, finishes and handles.	646,25
BLE Mifare DESFire: additional price to add to the Mifare DESFire price. Gross price	27,70



HID iCLASS: Standard - standard square spindles, finishes and handles.	626,55
HID iCLASS: Standard - 9mm square spindle, finishes and handles.	655,35
HID iCLASS: Wireless convertible - standard square spindles, finishes and handles.	665,40
HID iCLASS: Wireless convertible - 9mm square spindle, finishes and handles.	694,30
HID iCLASS: Wireless - standard square spindles, finishes and handles.	763,15
HID iCLASS: Wireless - 9mm square spindle, finishes and handles.	792,00
HID iCLASS: Amok - standard square spindles, finishes and handles.	907,75
HID iCLASS: Amok - 9mm square spindle, finishes and handles.	936,60
BLE HID iCLASS: additional price to add to the HID iCLASS price. Gross price	27,70



Model Ex654

SALTO XS4 Electronic Escutcheon Ex654,
2 Handles, any type, outside cylinder cut out.

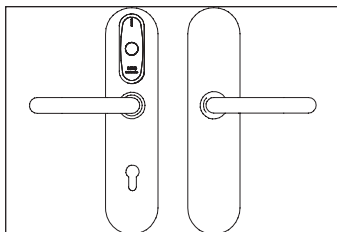

Inside Picopass
LEGIC advant - Prime
Mifare - DESFire
BLE Mifare DESFire
HID iCLASS
BLE HID iCLASS

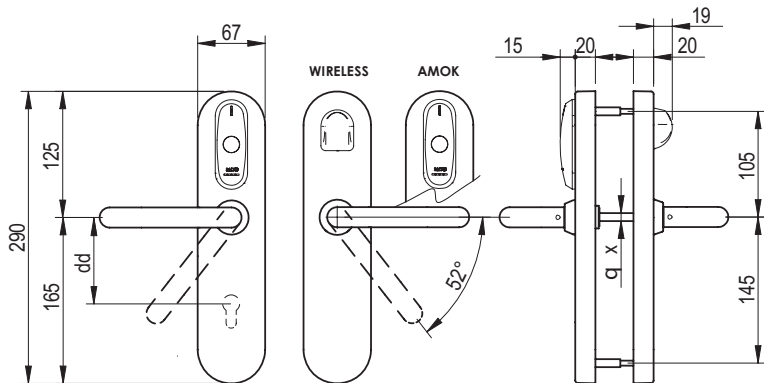

Technology	Escutcheon width	Function	Handle	Handle to thumbturn	Finish	Door thickness	Square spindle	Handing	Wireless option	Gain durability	
E7 PICOPASS	6	54	U	70	IM	2 Fo = 15-17,5mm	7 7mm	-	-		
			L	72				-			
			W					-			
E8 LEGIC			H ²	7F	IP ²	3 32-47 mm	8 8mm	-			
			Y ²	78				-			
			S ^{1,2}					R/L ¹			
E9 MIFARE			B ²	85	PP	4 45-60mm	9 9mm	-			C Convertible
			P ²	88				-			
			O ¹	90				R/L ¹			
EB MIFARE BLE			J	90	PM	5 Fo = 20-22,5mm	S 8mm split	-			W Wireless
			T	92				-			
			Z	10				-			
EH HID iCLASS	G	10	IA	6 60-75mm	V 9mm split	-	A ³ Amok				
	N	11				-					
	K ¹	3R				R/L ¹					
EJ BLE HID iCLASS	2 ²	4R	NE ²	7 75-90mm	6 7,6mm split	-					
	3 ²	7R				-					
	4 ²	9R				-					
	5 ²		BC ² BioCote	9 90-105mm Fo = 16.5 -59mm		-					
	7 ²	1 105-120mm Fo = 30.5 - 89mm				-					

Additional Prices - Gross prices



¹ For Handed lever handles, only for S, O or K handles.

² This option has an additional price please refer to the handles or finishes chapter.

³ Not available in BLE Mifare DESFire.

Ref	Remarks	€
G	Gain durability	21,30

Model Ex654	SALTO XS4 Electronic Escutcheon Ex654, 2 Handles, any type, outside cylinder cut out.
--------------------	--

Prices - Gross prices	€
------------------------------	---



Picopass: Standard - standard square spindles, finishes and handles.	517,00
Picopass: Standard - 9mm square spindle, finishes and handles.	545,75
Picopass: Wireless convertible - standard square spindles, finishes and handles.	555,75
Picopass: Wireless convertible - 9mm square spindle, finishes and handles.	584,50
Picopass: Wireless - standard square spindles, finishes and handles.	653,45
Picopass: Wireless - 9mm square spindle, finishes and handles.	682,30
Picopass: Amok - standard square spindles, finishes and handles.	686,85
Picopass: Amok - 9mm square spindle, finishes and handles.	715,60



Legic: Standard - standard square spindles, finishes and handles.	492,20
Legic: Standard - 9mm square spindle, finishes and handles.	521,00
Legic: Wireless convertible - standard square spindles, finishes and handles.	531,05
Legic: Wireless convertible - 9mm square spindle, finishes and handles.	559,85
Legic: Wireless - standard square spindles, finishes and handles.	628,80
Legic: Wireless - 9mm square spindle, finishes and handles.	657,65
Legic: Amok - standard square spindles, finishes and handles.	617,40
Legic: Amok - 9mm square spindle, finishes and handles.	646,25



Mifare DESFire: Standard - standard square spindles, finishes and handles.	492,20
Mifare DESFire: Standard - 9mm square spindle, finishes and handles.	521,00
Mifare DESFire: Wireless convertible - standard square spindles, finishes and handles.	531,05
Mifare DESFire: Wireless convertible - 9mm square spindle, finishes and handles.	559,85
Mifare DESFire: Wireless - standard square spindles, finishes and handles.	628,80
Mifare DESFire: Wireless - 9mm square spindle, finishes and handles.	657,65
Mifare DESFire: Amok - standard square spindles, finishes and handles.	617,40
Mifare DESFire: Amok - 9mm square spindle, finishes and handles.	646,25



BLE Mifare DESFire: additional price to add to the Mifare DESFire price. Gross price	27,70
---	-------



HID iCLASS: Standard - standard square spindles, finishes and handles.	626,55
HID iCLASS: Standard - 9mm square spindle, finishes and handles.	655,35
HID iCLASS: Wireless convertible - standard square spindles, finishes and handles.	665,40
HID iCLASS: Wireless convertible - 9mm square spindle, finishes and handles.	694,30
HID iCLASS: Wireless - standard square spindles, finishes and handles.	763,15
HID iCLASS: Wireless - 9mm square spindle, finishes and handles.	792,00
HID iCLASS: Amok - standard square spindles, finishes and handles.	907,75
HID iCLASS: Amok - 9mm square spindle, finishes and handles.	936,60



BLE HID iCLASS: additional price to add to the HID iCLASS price. Gross price	27,70
---	-------

Model Ex656

SALTO XS4 Electronic Escutcheon Ex656,
2 Handles, any type, electronic “do not disturb” system.

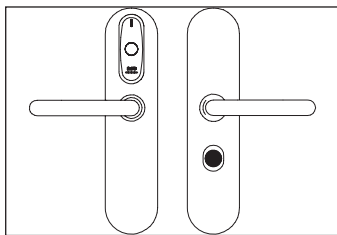

Inside Picopass
LEGIC advant - Prime
Mifare - DESFire
BLE Mifare DESFire
HID iCLASS
BLE HID iCLASS

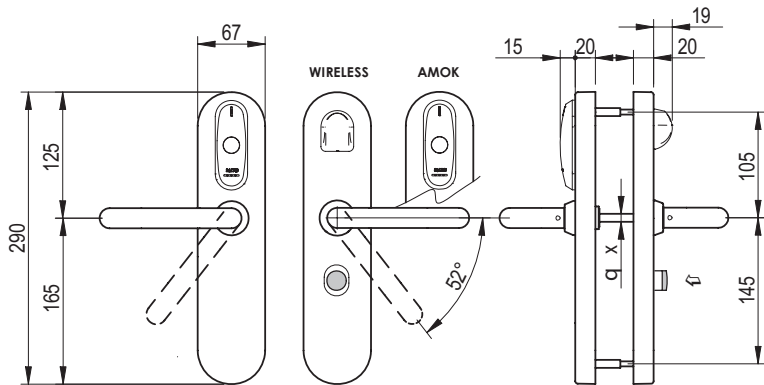

Technology	Escutcheon width	Function	Handle	Handle to thumbturn	Finish	Door thickness	Square spindle	Handing	Wireless option	Gain durability
E7 PICOPASS	6	56	U	00 without distance	IM	2 <i>Fo = 15-17,5mm</i>	7 7mm	-	-	-
			L			-				
			W			-				
E8 LEGIC			H ²		IP ²	3 32-47 mm	-			
			S ^{1,2}			8 8mm	A <i>Fo = 17.5 -20mm</i>	-		
			B ²				R/L ¹			
E9 MIFARE			P ²	PP	4 45-60mm	-	9 9mm	-	C Convertible	
			O ¹		B <i>Fo = 20-22,5mm</i>	R/L ¹				
			J	PM	-	-				
EB MIFARE BLE			T	7F 72mm for fire doors	IA	5 <i>Fo = 22.5-25mm</i>	S 8mm split	-	W Wireless	
			Z					-		
			G					-		
EH HID iCLASS	N	NE ²	6 60-75mm		V 9mm split	R/L ¹	G Gain durability			
	K ¹		7 75-90mm			-				
	2 ²		9 90-105mm <i>Fo = 16.5 -59mm</i>			-				
EJ BLE HID iCLASS	3 ²	BC ² BioCote	1 105-120mm <i>Fo = 30.5 - 89mm</i>	6 7,6mm split	-	A ³ Amok				
	4 ²		-							
	5 ²		-							
	7 ²									

Additional Prices - Gross prices



¹ For Handed lever handles, only for S, O or K handles.

² This option has an additional price please refer to the handles or finishes chapter.

³ Not available in BLE Mifare DESFire.

Ref	Remarks	€
G	Gain durability	21,30

Model Ex656

SALTO XS4 Electronic Escutcheon Ex656,
2 Handles, any type, electronic “do not disturb” system.

Prices - Gross prices

€



Picopass: Standard - standard square spindles, finishes and handles.	546,90
Picopass: Standard - 9mm square spindle, finishes and handles.	575,85
Picopass: Wireless convertible - standard square spindles, finishes and handles.	585,85
Picopass: Wireless convertible - 9mm square spindle, finishes and handles.	614,70
Picopass: Wireless - standard square spindles, finishes and handles.	683,65
Picopass: Wireless - 9mm square spindle, finishes and handles.	712,55
Picopass: Amok - standard square spindles, finishes and handles.	717,00
Picopass: Amok - 9mm square spindle, finishes and handles.	745,80



Legic: Standard - standard square spindles, finishes and handles.	520,90
Legic: Standard - 9mm square spindle, finishes and handles.	549,75
Legic: Wireless convertible - standard square spindles, finishes and handles.	559,75
Legic: Wireless convertible - 9mm square spindle, finishes and handles.	588,55
Legic: Wireless - standard square spindles, finishes and handles.	657,55
Legic: Wireless - 9mm square spindle, finishes and handles.	686,45
Legic: Amok - standard square spindles, finishes and handles.	646,10
Legic: Amok - 9mm square spindle, finishes and handles.	674,90



Mifare DESFire: Standard - standard square spindles, finishes and handles.	520,90
Mifare DESFire: Standard - 9mm square spindle, finishes and handles.	549,75
Mifare DESFire: Wireless convertible - standard square spindles, finishes and handles.	559,75
Mifare DESFire: Wireless convertible - 9mm square spindle, finishes and handles.	588,55
Mifare DESFire: Wireless - standard square spindles, finishes and handles.	657,55
Mifare DESFire: Wireless - 9mm square spindle, finishes and handles.	686,45
Mifare DESFire: Amok - standard square spindles, finishes and handles.	646,10
Mifare DESFire: Amok - 9mm square spindle, finishes and handles.	674,90



BLE Mifare DESFire: additional price to add to the Mifare DESFire price. Gross price	27,70
--	--------------



HID iCLASS: Standard - standard square spindles, finishes and handles.	649,30
HID iCLASS: Standard - 9mm square spindle, finishes and handles.	678,15
HID iCLASS: Wireless convertible - standard square spindles, finishes and handles.	687,85
HID iCLASS: Wireless convertible - 9mm square spindle, finishes and handles.	716,85
HID iCLASS: Wireless - standard square spindles, finishes and handles.	785,85
HID iCLASS: Wireless - 9mm square spindle, finishes and handles.	814,70
HID iCLASS: Amok - standard square spindles, finishes and handles.	930,50
HID iCLASS: Amok - 9mm square spindle, finishes and handles.	959,20



BLE HID iCLASS: additional price to add to the HID iCLASS price. Gross price	27,70
--	--------------

Model Ex657

SALTO XS4 Electronic Escutcheon Ex657,
2 Handles, any type, outside cylinder cut out, electronic “do not disturb” system.

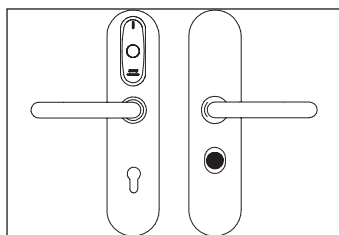

Inside Picopass
LEGIC advant - Prime
Mifare - DESFire
BLE Mifare DESFire
HID iCLASS
BLE HID iCLASS

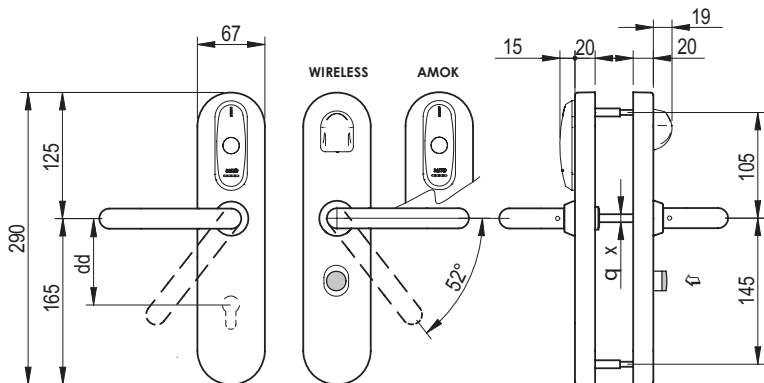

Technology	Escutcheon width	Function	Handle	Handle to thumbturn	Finish	Door thickness	Square spindle	Handing	Wireless option	Gain durability	
E7 PICOPASS	6	57	U	70	IM	2 Fo = 15-17,5mm	7 7mm	-	-		
			L	72				-			
			W	72				-			
E8 LEGIC			H ²	7F	IP ²	3 32-47 mm	8 8mm	-			
			Y ²	78				-			
			S ^{1,2}	78				R/L ¹			
E9 MIFARE			B ²	85	PP	4 45-60mm	9 9mm	-			C Convertible
			P ²	88				-			
			O ¹	88				R/L ¹			
EB MIFARE BLE			J	90	PM	B Fo = 20-22,5mm	S 8mm split	-			W Wireless
			T	92				-			
			Z	10				-			
EH HID iCLASS	N	11	IA	6 60-75mm	V 9mm split	-	G Gain durability				
	K ¹	3R				R/L ¹					
	2 ²	4R				-					
EJ BLE HID iCLASS	3 ²	4R	NE ²	7 75-90mm	6 7,6mm split	-	A ³ Amok				
	4 ²	7R				-					
	5 ²	9R				-					
					9 90-105mm Fo = 16.5 -59mm						
					1 105-120mm Fo = 30.5 - 89mm						
					BC ² BioCote						

Additional Prices - Gross prices



¹ For Handed lever handles, only for S, O or K handles.

² This option has an additional price please refer to the handles or finishes chapter.

³ Not available in BLE Mifare DESFire.

Ref	Remarks	€
G	Gain durability	21,30

Model Ex657

SALTO XS4 Electronic Escutcheon Ex657, 2 Handles, any type, outside cylinder cut out, electronic “do not disturb” system.

Prices - Gross prices

€



Picopass: Standard - standard square spindles, finishes and handles.	525,95
Picopass: Standard - 9mm square spindle, finishes and handles.	554,75
Picopass: Wireless convertible - standard square spindles, finishes and handles.	564,75
Picopass: Wireless convertible - 9mm square spindle, finishes and handles.	593,55
Picopass: Wireless - standard square spindles, finishes and handles.	662,55
Picopass: Wireless - 9mm square spindle, finishes and handles.	691,45
Picopass: Amok - standard square spindles, finishes and handles.	695,85
Picopass: Amok - 9mm square spindle, finishes and handles.	724,70



Legic: Standard - standard square spindles, finishes and handles.	520,90
Legic: Standard - 9mm square spindle, finishes and handles.	549,75
Legic: Wireless convertible - standard square spindles, finishes and handles.	559,75
Legic: Wireless convertible - 9mm square spindle, finishes and handles.	588,55
Legic: Wireless - standard square spindles, finishes and handles.	657,55
Legic: Wireless - 9mm square spindle, finishes and handles.	686,45
Legic: Amok - standard square spindles, finishes and handles.	646,10
Legic: Amok - 9mm square spindle, finishes and handles.	674,90

MIFARE DESFire

Mifare DESFire: Standard - standard square spindles, finishes and handles.	520,90
Mifare DESFire: Standard - 9mm square spindle, finishes and handles.	549,75
Mifare DESFire: Wireless convertible - standard square spindles, finishes and handles.	559,75
Mifare DESFire: Wireless convertible - 9mm square spindle, finishes and handles.	588,55
Mifare DESFire: Wireless - standard square spindles, finishes and handles.	657,55
Mifare DESFire: Wireless - 9mm square spindle, finishes and handles.	686,45
Mifare DESFire: Amok - standard square spindles, finishes and handles.	646,10
Mifare DESFire: Amok - 9mm square spindle, finishes and handles.	674,90



BLE Mifare DESFire: additional price to add to the Mifare DESFire price. Gross price	27,70
--	--------------



HID iCLASS: Standard - standard square spindles, finishes and handles.	649,30
HID iCLASS: Standard - 9mm square spindle, finishes and handles.	678,15
HID iCLASS: Wireless convertible - standard square spindles, finishes and handles.	687,85
HID iCLASS: Wireless convertible - 9mm square spindle, finishes and handles.	716,85
HID iCLASS: Wireless - standard square spindles, finishes and handles.	785,85
HID iCLASS: Wireless - 9mm square spindle, finishes and handles.	814,70
HID iCLASS: Amok - standard square spindles, finishes and handles.	930,50
HID iCLASS: Amok - 9mm square spindle, finishes and handles.	959,20



BLE HID iCLASS: additional price to add to the HID iCLASS price. Gross price	27,70
--	--------------

Model Ex658

SALTO XS4 Electronic Escutcheon Ex658, 2 Handles, any type, inside thumbturn 90°, with connector for mortise lock with micro-switch.

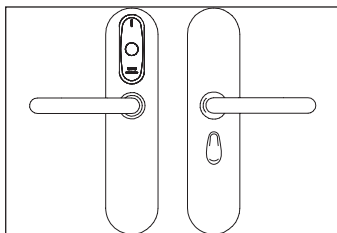

Inside Picopass
LEGIC advant - Prime
Mifare - DESFire
BLE Mifare DESFire
HID iCLASS
BLE HID iCLASS

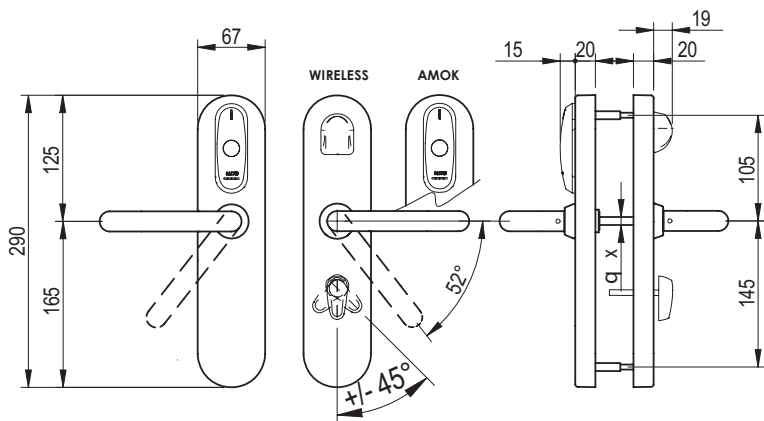

Technology	Escutcheon width	Function	Handle	Handle to thumbturn	Finish	Door thickness	Square spindle	Handing	Wireless option	Gain durability
E7 PICOPASS	6	58 ⁴	U	62	IM	3 32-47mm	7 7mm	-	-	
			L					-		
			W					-		
E8 LEGIC			H ²		IP ²	4 45-60mm	8 8mm	-		
			S ^{1,2}					R/L ¹		
			B ²					-		
E9 MIFARE			P ²		PP	6 60-75mm	9 9mm	-		
			O ¹					R/L ¹		
			J					-		
EB MIFARE BLE			T		PM	7 75-90mm	S	-		
			Z					-		
			G					-		
EH HID iCLASS	N	IA	9 90-105mm	8mm split	R/L ¹					
	K ¹				-					
	2 ²				-					
EJ BLE HID iCLASS	3 ²	NE ²	1 105-120mm	V 9mm split	-					
	4 ²				-					
	5 ²				-					
	7 ²	BC ² BioCote			-					

Additional Prices - Gross prices



¹ For Handed lever handles, only for S, O or K handles.

² This option has an additional price please refer to the handles or finishes chapter.

³ Not available in BLE Mifare DESFire.

⁴ To be used with inverted ANSI retrofit solutions.

Ref	Remarks	€
G	Gain durability	21,30

Model Ex658

SALTO XS4 Electronic Escutcheon Ex658, 2 Handles, any type, inside thumbturn 90°, with connector for mortise lock with micro-switch.

Prices - Gross prices

€



Picopass: Standard - standard square spindles, finishes and handles.	562,10
Picopass: Standard - 9mm square spindle, finishes and handles.	590,90
Picopass: Wireless convertible - standard square spindles, finishes and handles.	600,95
Picopass: Wireless convertible - 9mm square spindle, finishes and handles.	629,70
Picopass: Wireless - standard square spindles, finishes and handles.	698,65
Picopass: Wireless - 9mm square spindle, finishes and handles.	727,50
Picopass: Amok - standard square spindles, finishes and handles.	732,00
Picopass: Amok - 9mm square spindle, finishes and handles.	760,95



Legic: Standard - standard square spindles, finishes and handles.	535,35
Legic: Standard - 9mm square spindle, finishes and handles.	564,30
Legic: Wireless convertible - standard square spindles, finishes and handles.	574,20
Legic: Wireless convertible - 9mm square spindle, finishes and handles.	603,05
Legic: Wireless - standard square spindles, finishes and handles.	672,00
Legic: Wireless - 9mm square spindle, finishes and handles.	700,85
Legic: Amok - standard square spindles, finishes and handles.	660,50
Legic: Amok - 9mm square spindle, finishes and handles.	689,40

MIFARE DESFire

Mifare DESFire: Standard - standard square spindles, finishes and handles.	535,35
Mifare DESFire: Standard - 9mm square spindle, finishes and handles.	564,30
Mifare DESFire: Wireless convertible - standard square spindles, finishes and handles.	574,20
Mifare DESFire: Wireless convertible - 9mm square spindle, finishes and handles.	603,05
Mifare DESFire: Wireless - standard square spindles, finishes and handles.	672,00
Mifare DESFire: Wireless - 9mm square spindle, finishes and handles.	700,85
Mifare DESFire: Amok - standard square spindles, finishes and handles.	660,50
Mifare DESFire: Amok - 9mm square spindle, finishes and handles.	689,40
BLE Mifare DESFire: additional price to add to the Mifare DESFire price. Gross price	27,70



HID iCLASS: Standard - standard square spindles, finishes and handles.	649,30
HID iCLASS: Standard - 9mm square spindle, finishes and handles.	678,15
HID iCLASS: Wireless convertible - standard square spindles, finishes and handles.	687,85
HID iCLASS: Wireless convertible - 9mm square spindle, finishes and handles.	716,85
HID iCLASS: Wireless - standard square spindles, finishes and handles.	785,85
HID iCLASS: Wireless - 9mm square spindle, finishes and handles.	814,70
HID iCLASS: Amok - standard square spindles, finishes and handles.	930,50
HID iCLASS: Amok - 9mm square spindle, finishes and handles.	959,20
BLE HID iCLASS: additional price to add to the HID iCLASS price. Gross price	27,70



Model Ex6P0

SALTO XS4 Electronic Escutcheon Ex6P0,
2 Handles, any type, built in mechanical cylinder with audit,
(mechanical cylinder not included, for technical specifications consult SALTO).

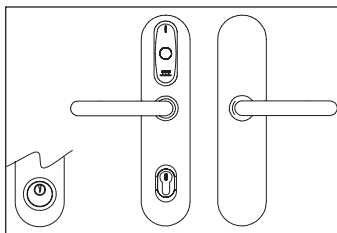

Inside Picopass
LEGIC advant - Prime
Mifare - DESFire
BLE Mifare DESFire
HID iCLASS
BLE HID iCLASS

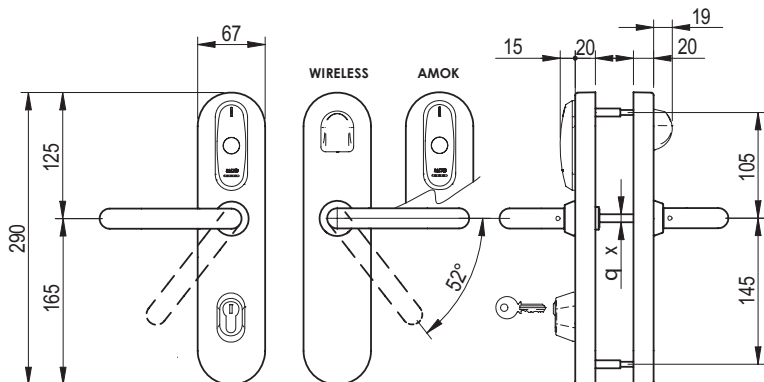

Technology	Escutcheon width	Function	Handle	Handle to thumbturn	Finish	Door thickness	Square spindle	Handing	Wireless option	Gain durability
E7 PICOPASS	6	60 Mortise cylinder 1-1/8"	U	00 Without cylinder	IM	2 Fo = 15-17,5mm	7 7mm	-	-	-
			L			-				
			W			-				
E8 LEGIC			H ²		IP ²	3 32-47 mm	-			
			Y ²			-				
			S ^{1,2}			-				
E9 MIFARE		B ²	PP		4 45-60mm	-	8 8mm	R/L ¹	C Convertible	
		P ²			-					
		O ¹			-					
EB MIFARE BLE		J	PM		5 Fo = 20-22,5mm	-	9 9mm	R/L ¹	W Wireless	
	T	-								
	Z	-								
EH HID iCLASS	G	IA	6 60-75mm	-	S 8mm split	-	A ³ Amok			
	N		-							
	K ¹		-							
EJ BLE HID iCLASS	2 ²	NE ²	7 75-90mm	-	V 9mm split	R/L ¹	G Gain durability			
	3 ²		-							
	4 ²		-							
	9 90-105mm Fo = 16.5 - 59mm	BC ² BioCote	1 105-120mm Fo = 30.5 - 89mm	-	6 7,6mm split	-				
	5 ²		-							
	7 ²		-							



¹ For Handed lever handles, only for S, O or K handles.

² This option has an additional price please refer to the handles or finishes chapter.

³ Not available in BLE Mifare DESFire.

Cylinders for the override

Model P

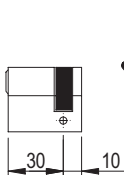

Model 6
Mortise cylinder

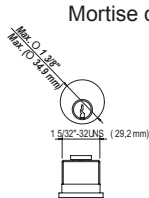

Additional Prices - Gross prices

Ref	Remarks	€
G	Gain durability	21,30

Model Ex6P0

SALTO XS4 Electronic Escutcheon Ex6P0,
2 Handles, any type, built in mechanical cylinder with audit,
(mechanical cylinder not included, for technical specifications consult SALTO).

Prices - Gross prices

€



Picopass: Standard - standard square spindles, finishes and handles.	525,95
Picopass: Standard - 9mm square spindle, finishes and handles.	554,75
Picopass: Wireless convertible - standard square spindles, finishes and handles.	564,75
Picopass: Wireless convertible - 9mm square spindle, finishes and handles.	593,55
Picopass: Wireless - standard square spindles, finishes and handles.	662,55
Picopass: Wireless - 9mm square spindle, finishes and handles.	691,45
Picopass: Amok - standard square spindles, finishes and handles.	695,85
Picopass: Amok - 9mm square spindle, finishes and handles.	724,70



Legic: Standard - standard square spindles, finishes and handles.	501,25
Legic: Standard - 9mm square spindle, finishes and handles.	530,05
Legic: Wireless convertible - standard square spindles, finishes and handles.	540,15
Legic: Wireless convertible - 9mm square spindle, finishes and handles.	568,90
Legic: Wireless - standard square spindles, finishes and handles.	637,95
Legic: Wireless - 9mm square spindle, finishes and handles.	666,70
Legic: Amok - standard square spindles, finishes and handles.	626,50
Legic: Amok - 9mm square spindle, finishes and handles.	655,25

MIFARE DESFire

Mifare DESFire: Standard - standard square spindles, finishes and handles.	501,25
Mifare DESFire: Standard - 9mm square spindle, finishes and handles.	530,05
Mifare DESFire: Wireless convertible - standard square spindles, finishes and handles.	540,15
Mifare DESFire: Wireless convertible - 9mm square spindle, finishes and handles.	568,90
Mifare DESFire: Wireless - standard square spindles, finishes and handles.	637,95
Mifare DESFire: Wireless - 9mm square spindle, finishes and handles.	666,70
Mifare DESFire: Amok - standard square spindles, finishes and handles.	626,50
Mifare DESFire: Amok - 9mm square spindle, finishes and handles.	655,25
BLE Mifare DESFire: additional price to add to the Mifare DESFire price. Gross price	27,70



HID iCLASS: Standard - standard square spindles, finishes and handles.	622,60
HID iCLASS: Standard - 9mm square spindle, finishes and handles.	651,45
HID iCLASS: Wireless convertible - standard square spindles, finishes and handles.	661,50
HID iCLASS: Wireless convertible - 9mm square spindle, finishes and handles.	690,30
HID iCLASS: Wireless - standard square spindles, finishes and handles.	759,35
HID iCLASS: Wireless - 9mm square spindle, finishes and handles.	788,10
HID iCLASS: Amok - standard square spindles, finishes and handles.	903,80
HID iCLASS: Amok - 9mm square spindle, finishes and handles.	932,75
BLE HID iCLASS: additional price to add to the HID iCLASS price. Gross price	27,70



Model Ex6P1

SALTO XS4 Electronic Escutcheon Ex6P1, Ex661,
2 Handles, any type, inside thumbturn, built in mechanical cylinder with audit,
(mechanical cylinder not included, for technical specifications consult SALTO).

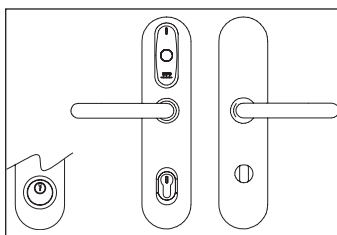

Inside Picopass
LEGIC advant - Prime
Mifare - DESFire
BLE Mifare DESFire
HID iCLASS
BLE HID iCLASS

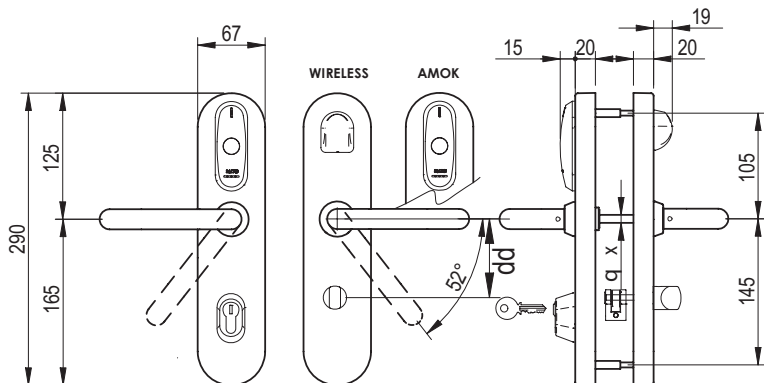

Technology	Escutcheon width	Function	Handle	Handle to thumbturn	Finish	Door thickness	Square spindle	Handing	Wireless option	Gain durability	
E7 PICOPASS	6	61 Mortise cylinder 1-1/8"	U	47	IM	3 32-47mm	7 7mm	-	-	-	
			L	48							
			W	49							
E8 LEGIC			H ²	55	IP ²	4 45-60mm	8 8mm	-			
			S ^{1,2}	62				R/L ¹			
			B ²	70				-			
E9 MIFARE			P ²	72	PP	6 60-75mm	9 9mm	-			
			O ¹	78				R/L ¹			
			J	3R				-			
EB MIFARE BLE		P1 Euro profile cylinder 30-10	P1	T	4R	PM	7 75-90mm	S	-		W Wireless
				Z	7R						
	G			85							
EH HID iCLASS	K ¹			88	IA	9 90-105mm	8mm split	R/L ¹			
	2 ²			90				-			
	3 ²			92				-			
EJ BLE HID iCLASS	4 ²			9R	NE ²	1 105-120mm	V 9mm split	-	A ³ Amok		
	5 ²			10				-			
	7 ²			11				-			
					BC ² BioCote				G Gain durability		



¹ For Handed lever handles, only for S, O or K handles.

² This option has an additional price please refer to the handles or finishes chapter.

³ Not available in BLE Mifare DESFire.

Cylinders for the override

Model P

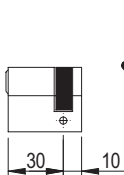

Model 6
Mortise cylinder

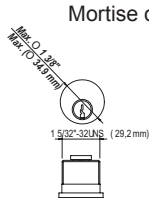

Additional Prices - Gross prices

Ref	Remarks	€
G	Gain durability	21,30

Model Ex6P1

SALTO XS4 Electronic Escutcheon Ex6P1, Ex661, 2 Handles, any type, inside thumbturn, built in mechanical cylinder with audit, (mechanical cylinder not included, for technical specifications consult SALTO).

Prices - Gross prices

€



Picopass: Standard - standard square spindles, finishes and handles.	569,40
Picopass: Standard - 9mm square spindle, finishes and handles.	598,25
Picopass: Wireless convertible - standard square spindles, finishes and handles.	608,25
Picopass: Wireless convertible - 9mm square spindle, finishes and handles.	637,10
Picopass: Wireless - standard square spindles, finishes and handles.	706,05
Picopass: Wireless - 9mm square spindle, finishes and handles.	734,85
Picopass: Amok - standard square spindles, finishes and handles.	739,40
Picopass: Amok - 9mm square spindle, finishes and handles.	768,25



Legic: Standard - standard square spindles, finishes and handles.	542,70
Legic: Standard - 9mm square spindle, finishes and handles.	571,50
Legic: Wireless convertible - standard square spindles, finishes and handles.	581,55
Legic: Wireless convertible - 9mm square spindle, finishes and handles.	610,40
Legic: Wireless - standard square spindles, finishes and handles.	679,30
Legic: Wireless - 9mm square spindle, finishes and handles.	708,25
Legic: Amok - standard square spindles, finishes and handles.	667,85
Legic: Amok - 9mm square spindle, finishes and handles.	696,75



Mifare DESFire: Standard - standard square spindles, finishes and handles.	542,70
Mifare DESFire: Standard - 9mm square spindle, finishes and handles.	571,50
Mifare DESFire: Wireless convertible - standard square spindles, finishes and handles.	581,55
Mifare DESFire: Wireless convertible - 9mm square spindle, finishes and handles.	610,40
Mifare DESFire: Wireless - standard square spindles, finishes and handles.	679,30
Mifare DESFire: Wireless - 9mm square spindle, finishes and handles.	708,25
Mifare DESFire: Amok - standard square spindles, finishes and handles.	667,85
Mifare DESFire: Amok - 9mm square spindle, finishes and handles.	696,75



BLE Mifare DESFire: additional price to add to the Mifare DESFire price. Gross price	27,70
--	--------------



HID iCLASS: Standard - standard square spindles, finishes and handles.	656,60
HID iCLASS: Standard - 9mm square spindle, finishes and handles.	685,30
HID iCLASS: Wireless convertible - standard square spindles, finishes and handles.	695,35
HID iCLASS: Wireless convertible - 9mm square spindle, finishes and handles.	724,20
HID iCLASS: Wireless - standard square spindles, finishes and handles.	793,25
HID iCLASS: Wireless - 9mm square spindle, finishes and handles.	822,10
HID iCLASS: Amok - standard square spindles, finishes and handles.	937,80
HID iCLASS: Amok - 9mm square spindle, finishes and handles.	966,65



BLE HID iCLASS: additional price to add to the HID iCLASS price. Gross price	27,70
--	--------------

Model Ex6P6

SALTO XS4 Electronic Escutcheon Ex6P6, Ex666,
2 Handles, any type, electronic "do not disturb" system, built in mechanical cylinder with audit, (mechanical cylinder not included, for technical specifications consult SALTO)

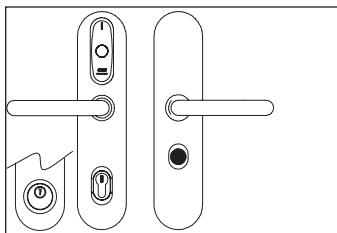

Inside Picopass
LEGIC advant - Prime
Mifare - DESFire
BLE Mifare DESFire
HID iCLASS
BLE HID iCLASS

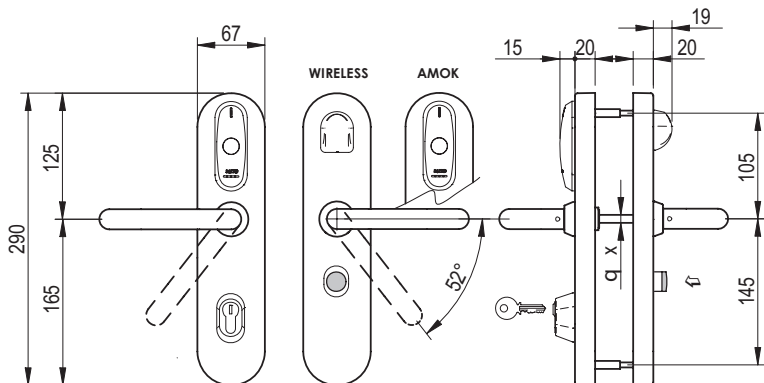

Technology	Escutcheon width	Function	Handle	Handle to thumbturn	Finish	Door thickness	Square spindle	Handing	Wireless option	Gain durability
E7 PICOPASS	6	66 Mortise cylinder 1-1/8"	U	00 without distance	IM	2 Fo = 15-17,5mm	7 7mm	-	-	
			L					-		
			W					-		
E8 LEGIC			H ²		IP ²	3 32-47 mm	-			
			Y ²				-			
			S ^{1,2}				-			
E9 MIFARE		B ²	PP		4 45-60mm	-	8 8mm	R/L ¹	C Convertible	
		P ²				-				
		O ¹				-				
EB MIFARE BLE		J	PM			-	9 9mm	R/L ¹	W Wireless	
	T			-						
	Z			-						
EH HID iCLASS	G	IA		-	S 8mm split	-	G Gain durability			
	N			-						
	K ¹			-						
EJ BLE HID iCLASS	2 ²	NE ²		-	V 9mm split	R/L ¹	A ³ Amok			
	3 ²			-						
	4 ²			-						
	5 ²	BC ² BioCote		-	6 7,6mm split	-				
	7 ²			-						
				-						
		P6 Euro profile cylinder 30-10								



¹ For Handed lever handles, only for S, O or K handles.

² This option has an additional price please refer to the handles or finishes chapter.

³ Not available in BLE Mifare DESFire.

Cylinders for the override

Model P

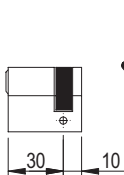

Model 6
Mortise cylinder

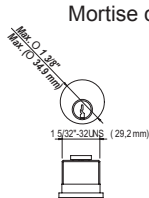

Additional Prices - Gross prices

Ref	Remarks	€
G	Gain durability	21,30

Model Ex6P6

SALTO XS4 Electronic Escutcheon Ex6P6, Ex666, 2 Handles, any type, electronic “do not disturb” system, built in mechanical cylinder with audit, (mechanical cylinder not included, for technical specifications consult SALTO)

Prices - Gross prices

€



Picopass: Standard - standard square spindles, finishes and handles.	554,35
Picopass: Standard - 9mm square spindle, finishes and handles.	583,15
Picopass: Wireless convertible - standard square spindles, finishes and handles.	593,15
Picopass: Wireless convertible - 9mm square spindle, finishes and handles.	622,00
Picopass: Wireless - standard square spindles, finishes and handles.	690,85
Picopass: Wireless - 9mm square spindle, finishes and handles.	719,80
Picopass: Amok - standard square spindles, finishes and handles.	724,30
Picopass: Amok - 9mm square spindle, finishes and handles.	753,10



Legic: Standard - standard square spindles, finishes and handles.	528,20
Legic: Standard - 9mm square spindle, finishes and handles.	557,10
Legic: Wireless convertible - standard square spindles, finishes and handles.	567,15
Legic: Wireless convertible - 9mm square spindle, finishes and handles.	595,95
Legic: Wireless - standard square spindles, finishes and handles.	664,80
Legic: Wireless - 9mm square spindle, finishes and handles.	693,65
Legic: Amok - standard square spindles, finishes and handles.	653,25
Legic: Amok - 9mm square spindle, finishes and handles.	682,25

MIFARE DESFire

Mifare DESFire: Standard - standard square spindles, finishes and handles.	528,20
Mifare DESFire: Standard - 9mm square spindle, finishes and handles.	557,10
Mifare DESFire: Wireless convertible - standard square spindles, finishes and handles.	567,15
Mifare DESFire: Wireless convertible - 9mm square spindle, finishes and handles.	595,95
Mifare DESFire: Wireless - standard square spindles, finishes and handles.	664,80
Mifare DESFire: Wireless - 9mm square spindle, finishes and handles.	693,65
Mifare DESFire: Amok - standard square spindles, finishes and handles.	653,25
Mifare DESFire: Amok - 9mm square spindle, finishes and handles.	682,25



BLE Mifare DESFire: additional price to add to the Mifare DESFire price. Gross price	27,70
--	--------------



HID iCLASS: Standard - standard square spindles, finishes and handles.	656,60
HID iCLASS: Standard - 9mm square spindle, finishes and handles.	685,30
HID iCLASS: Wireless convertible - standard square spindles, finishes and handles.	695,35
HID iCLASS: Wireless convertible - 9mm square spindle, finishes and handles.	724,20
HID iCLASS: Wireless - standard square spindles, finishes and handles.	793,25
HID iCLASS: Wireless - 9mm square spindle, finishes and handles.	822,10
HID iCLASS: Amok - standard square spindles, finishes and handles.	937,80
HID iCLASS: Amok - 9mm square spindle, finishes and handles.	966,65



BLE HID iCLASS: additional price to add to the HID iCLASS price. Gross price	27,70
--	--------------

Model Ex6P8

SALTO XS4 Electronic Escutcheon Ex6P8, Ex668,
2 Handles, any type, inside thumbturn 90°, with connector for mortise lock
with micro-switch.

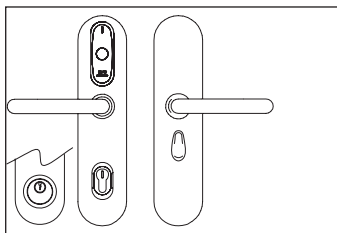

Inside Picopass
LEGIC advant - Prime
Mifare - DESFire
BLE Mifare DESFire
HID iCLASS
BLE HID iCLASS

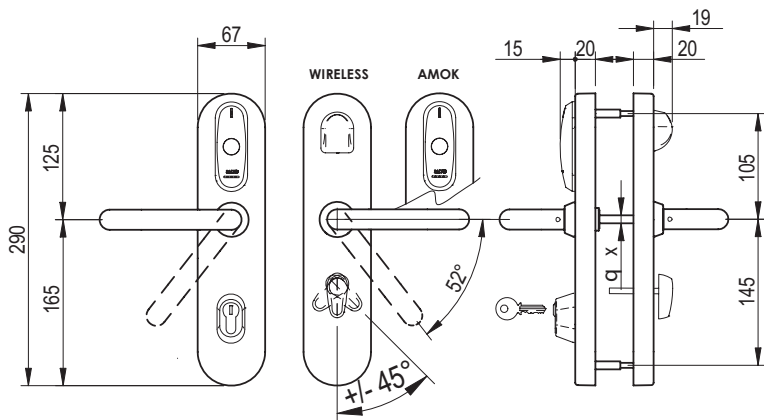

Technology	Escutcheon width	Function	Handle	Handle to thumbturn	Finish	Door thickness	Square spindle	Handing	Wireless option	Gain durability					
E7 PICOPASS	6	68 Mortise cylinder 1-1/8"	U	62	IM	3 32-47mm	7 7mm	-	-						
			L					-							
			W					-							
E8 LEGIC			H ²		IP ²	4 45-60mm	8 8mm	-							
								E9 MIFARE			S ^{1,2}	PP	6 60-75mm	9 9mm	R/L ¹
															B ²
E9 MIFARE		P ²	PM		7 75-90mm	S	-								
							O ¹	R/L ¹							
EB MIFARE BLE		P8 Euro profile cylinder 30-10	J		T	IA	9 90-105mm	8mm split	-		C Convertible				
					Z				-						
					G				-						
EH HID iCLASS		N	K ¹		NE ²	1 105-120mm	V 9mm split	R/L ¹	W Wireless						
	EJ BLE HID iCLASS			2 ²				BC ² BioCote		-	-				
												3 ²	-		
EJ BLE HID iCLASS	4 ²	-	-	-	-	-	A ³ Amok								
								5 ²	-						
EJ BLE HID iCLASS	7 ²	-	-	-	-	-	G Gain durability								



¹ For Handed lever handles, only for S, O or K handles.

² This option has an additional price please refer to the handles or finishes chapter.

³ Not available in BLE Mifare DESFire.

Cylinders for the override

Model P

Model 6
Mortise cylinder

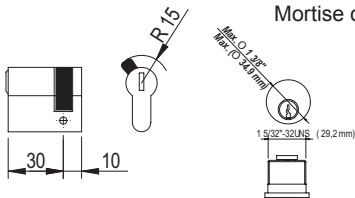

Additional Prices - Gross prices

Ref	Remarks	€
G	Gain durability	21,30

Model Ex6P8

SALTO XS4 Electronic Escutcheon Ex6P8, Ex668, 2 Handles, any type, inside thumbturn 90°, with connector for mortise lock with micro-switch.

Prices - Gross prices

€



Picopass: Standard - standard square spindles, finishes and handles.	569,40
Picopass: Standard - 9mm square spindle, finishes and handles.	598,25
Picopass: Wireless convertible - standard square spindles, finishes and handles.	608,25
Picopass: Wireless convertible - 9mm square spindle, finishes and handles.	637,10
Picopass: Wireless - standard square spindles, finishes and handles.	706,05
Picopass: Wireless - 9mm square spindle, finishes and handles.	734,85
Picopass: Amok - standard square spindles, finishes and handles.	739,40
Picopass: Amok - 9mm square spindle, finishes and handles.	768,25



Legic: Standard - standard square spindles, finishes and handles.	542,70
Legic: Standard - 9mm square spindle, finishes and handles.	571,50
Legic: Wireless convertible - standard square spindles, finishes and handles.	581,55
Legic: Wireless convertible - 9mm square spindle, finishes and handles.	610,40
Legic: Wireless - standard square spindles, finishes and handles.	679,30
Legic: Wireless - 9mm square spindle, finishes and handles.	708,25
Legic: Amok - standard square spindles, finishes and handles.	667,85
Legic: Amok - 9mm square spindle, finishes and handles.	696,75

MIFARE DESFire

Mifare DESFire: Standard - standard square spindles, finishes and handles.	542,70
Mifare DESFire: Standard - 9mm square spindle, finishes and handles.	571,50
Mifare DESFire: Wireless convertible - standard square spindles, finishes and handles.	581,55
Mifare DESFire: Wireless convertible - 9mm square spindle, finishes and handles.	610,40
Mifare DESFire: Wireless - standard square spindles, finishes and handles.	679,30
Mifare DESFire: Wireless - 9mm square spindle, finishes and handles.	708,25
Mifare DESFire: Amok - standard square spindles, finishes and handles.	667,85
Mifare DESFire: Amok - 9mm square spindle, finishes and handles.	696,75
BLE Mifare DESFire: additional price to add to the Mifare DESFire price. Gross price	27,70



HID iCLASS: Standard - standard square spindles, finishes and handles.	656,60
HID iCLASS: Standard - 9mm square spindle, finishes and handles.	685,30
HID iCLASS: Wireless convertible - standard square spindles, finishes and handles.	695,35
HID iCLASS: Wireless convertible - 9mm square spindle, finishes and handles.	724,20
HID iCLASS: Wireless - standard square spindles, finishes and handles.	793,25
HID iCLASS: Wireless - 9mm square spindle, finishes and handles.	822,10
HID iCLASS: Amok - standard square spindles, finishes and handles.	937,80
HID iCLASS: Amok - 9mm square spindle, finishes and handles.	966,65
BLE HID iCLASS: additional price to add to the HID iCLASS price. Gross price	27,70



Model Ex650xK SALTO XS4 Electronic Escutcheon Ex650, with keypad, 2 Handles, any type.

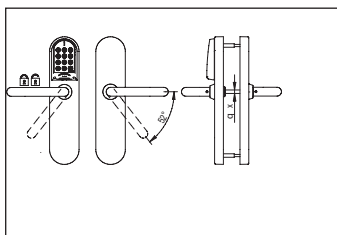

BLE MIFARE - DESFire
BLE HID iCLASS

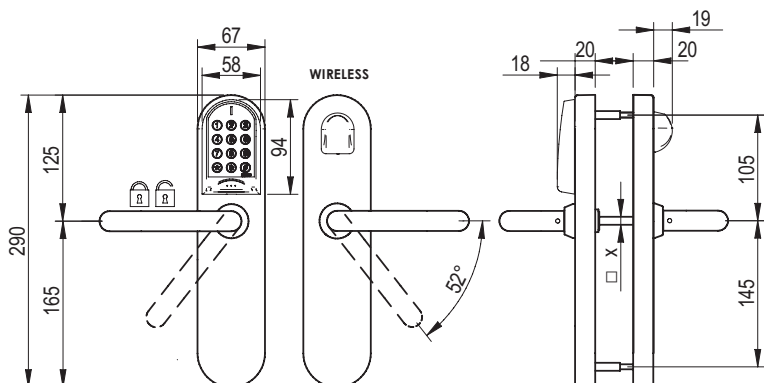

Technology	Escutcheon width	Function	Handle	Handle to thumbturn	Finish	Door thickness	Square spindle	Handing	Wireless option	Keypad option	Gain durability
EB BLE MIFARE DESFire	6	50	U	00 without distance	IM	2 <i>Fo = 15-17,5mm</i>	7 7mm	-	-	K	-
			L			-					
			W			-					
			H ²			-					
			Y ²		IP ²	3 32-47 mm	-				
			S ^{1,2}			A <i>Fo = 17.5 -20mm</i>	R/L ¹				
			B ²		PP	4 45-60mm	-				
			P ²			-					
			O ¹		PM	9 9mm	R/L ¹				
			J			B <i>Fo = 20-22,5mm</i>	-				
EJ BLE HID iCLASS	6	50	T	7F 72mm for fire doors	PM	5 <i>Fo = 22.5-25mm</i>	S 8mm split	-	C Convertible	G Gain durability	
			Z			-					
			G		IA	6 60-75mm	-				
			N			-					
			K ¹		NE ²	7 75-90mm	R/L ¹				
			2 ²			V 9mm split	-				
			3 ²		BC ² BioCote	9 90-105mm <i>Fo = 16.5 -59mm</i>	-				
			4 ²			6 7,6mm split	-				
5 ²	W Wireless	-									
7 ²	1 105-120mm <i>Fo = 30.5 - 89mm</i>	-									

Additional Prices - Gross prices



¹ For Handed lever handles, only for S, O or K handles.



² This option has an additional price please refer to the handles or finishes chapter.

Ref	Remarks	€
G	Gain durability	21,30

Model Ex650xK	SALTO XS4 Electronic Escutcheon Ex650, with keypad, 2 Handles, any type.
----------------------	--

Prices - Gross prices	€
------------------------------	---

	MIFARE DESFire	BLE MIFARE DESFire: Standard - standard square spindles, finishes and handles.	620,40
		BLE MIFARE DESFire: Standard - 9mm square spindle, finishes and handles.	655,00
		BLE MIFARE DESFire: Wireless convertible - standard square spindles, finishes and handles.	666,95
		BLE MIFARE DESFire: Wireless convertible - 9mm square spindle, finishes and handles.	701,55
		BLE MIFARE DESFire: Wireless - standard square spindles, finishes and handles.	784,40
		BLE MIFARE DESFire: Wireless - 9mm square spindle, finishes and handles.	818,95

		BLE HID iCLASS: Standard - standard square spindles, finishes and handles.	765,50
		BLE HID iCLASS: Standard - 9mm square spindle, finishes and handles.	800,10
		BLE HID iCLASS: Wireless convertible - standard square spindles, finishes and handles.	812,15
		BLE HID iCLASS: Wireless convertible - 9mm square spindle, finishes and handles.	846,85
		BLE HID iCLASS: Wireless - standard square spindles, finishes and handles.	929,50
		BLE HID iCLASS: Wireless - 9mm square spindle, finishes and handles.	964,05

Model Ex651xK

SALTO XS4 Electronic Escutcheon Ex651, with keypad, 2 Handles, any type, inside thumbturn, with connector for mortise lock with micro-switch.

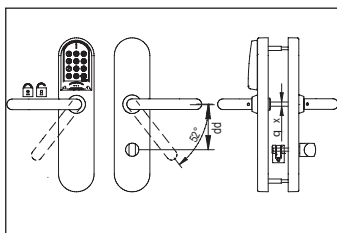

BLE MIFARE - DESFire
 BLE HID iCLASS

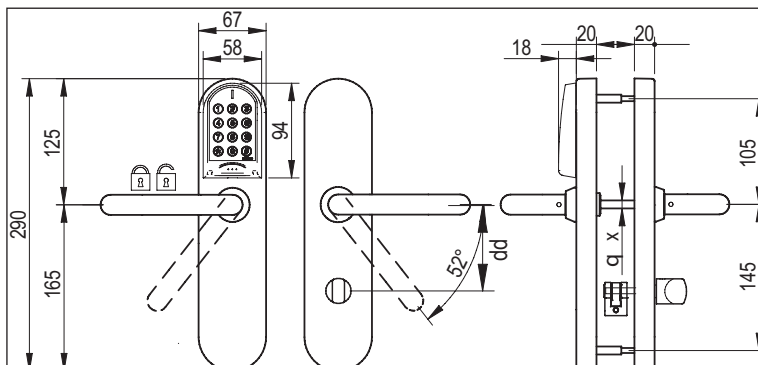

Technology	Escutcheon width	Function	Handle	Handle to thumbturn	Finish	Door thickness	Square spindle	Handing	Wireless option	Keypad option	Gain durability
EB BLE MIFARE DESFire	6	51	U	47	IM	3 32-47 mm	7 7mm	-	-	K	-
			L	48				-			
			W	49				-			
			H ²	55	IP ²	4 45-60mm	-				
			Y ²	62			-				
			S ^{1,2}	70	PP	6 60-75mm	R/L ¹				
			B ²	72			-				
			P ²	78			-				
			O ¹	7F			R/L ¹				
			EJ BLE HID iCLASS	6	51	J	3R	PM			
T	4R	-									
Z	7R	IA				9 90-105mm	-				
G	85						-				
N	88						R/L ¹				
K ¹	90	NE ²				1 105-120mm	-				
2 ²	92						-				
3 ²	9R	BC ² BioCote				V 9mm split	-				
4 ²	10						-				
5 ²	11						-				

Additional Prices - Gross prices



¹ For Handed lever handles, only for S, O or K handles.

² This option has an additional price please refer to the handles or finishes chapter.

Ref	Remarks	€
G	Gain durability	21,30

European wide body escutcheon with keypad

Model Ex651xK

SALTO XS4 Electronic Escutcheon Ex651, with keypad, 2 Handles, any type, inside thumbturn, with connector for mortise lock with micro-switch.

Prices - Gross prices

€



BLE MIFARE DESFire: Standard - standard square spindles, finishes and handles.	670,15
BLE MIFARE DESFire: Standard - 9mm square spindle, finishes and handles.	704,75
BLE MIFARE DESFire: Wireless convertible - standard square spindles, finishes and handles.	716,85
BLE MIFARE DESFire: Wireless convertible - 9mm square spindle, finishes and handles.	751,35
BLE MIFARE DESFire: Wireless - standard square spindles, finishes and handles.	834,05
BLE MIFARE DESFire: Wireless - 9mm square spindle, finishes and handles.	868,75



BLE HID iCLASS: Standard - standard square spindles, finishes and handles.	806,25
BLE HID iCLASS: Standard - 9mm square spindle, finishes and handles.	840,90
BLE HID iCLASS: Wireless convertible - standard square spindles, finishes and handles.	852,70
BLE HID iCLASS: Wireless convertible - 9mm square spindle, finishes and handles.	887,30
BLE HID iCLASS: Wireless - standard square spindles, finishes and handles.	970,20
BLE HID iCLASS: Wireless - 9mm square spindle, finishes and handles.	1004,80

Model Ex652xK SALTO XS4 Electronic Escutcheon Ex652, with keypad, 2 Handles, any type, Inside/Outside cylinder cut out.

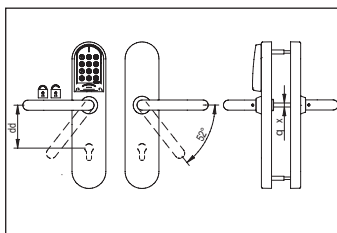

BLE MIFARE - DESFire
BLE HID iCLASS

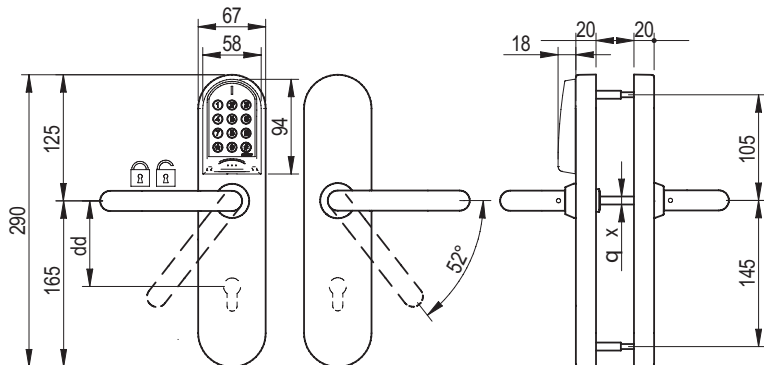

Technology	Escutcheon width	Function	Handle	Handle to thumbturn	Finish	Door thickness	Square spindle	Handing	Wireless option	Keypad option	Gain durability
EB BLE MIFARE DESFire	6	52	U	70	IM	2 <i>Fo = 15-17,5mm</i>	7 7mm	-	-	K	-
			L	72				-			
			W					-			
			H ²	7F	IP ²	3 32-47 mm	8 8mm	-			
			Y ²	78		-					
			S ^{1,2}			A <i>Fo = 17.5 -20mm</i>		R/L ¹			
			B ²	85	PP	4 45-60mm	9 9mm	-			
			P ²	88				-			
			O ¹	90				R/L ¹			
			EJ BLE HID iCLASS	6	52	J	90	PM			
T	92	-									
Z	10	IA				6 60-75mm	V 9mm split	-			
G								-			
N								11	R/L ¹		
K ¹	3R	NE ²				7 75-90mm	6 7,6mm split	-			
2 ²	4R							-			
3 ²	7R							-			
4 ²	9R	BC ² BioCote	9 90-105mm <i>Fo = 16.5 -59mm</i>	6	-						
5 ²					1 105-120mm <i>Fo = 30.5 - 89mm</i>	-					
7 ²	9R	-									

Additional Prices - Gross prices





¹ For Handed lever handles, only for S, O or K handles.

² This option has an additional price please refer to the handles or finishes chapter.

Ref	Remarks	€
G	Gain durability	21,30

Model Ex652xK

SALTO XS4 Electronic Escutcheon Ex652, with keypad, 2 Handles, any type, Inside/Outside cylinder cut out.

	Prices - Gross prices	€
	BLE MIFARE DESFire: Standard - standard square spindles, finishes and handles.	628,65
	BLE MIFARE DESFire: Standard - 9mm square spindle, finishes and handles.	663,10
	BLE MIFARE DESFire: Wireless convertible - standard square spindles, finishes and handles.	675,25
	BLE MIFARE DESFire: Wireless convertible - 9mm square spindle, finishes and handles.	709,65
	BLE MIFARE DESFire: Wireless - standard square spindles, finishes and handles.	792,65
	BLE MIFARE DESFire: Wireless - 9mm square spindle, finishes and handles.	827,05
<hr/>		
	BLE HID iCLASS: Standard - standard square spindles, finishes and handles.	782,85
	BLE HID iCLASS: Standard - 9mm square spindle, finishes and handles.	817,45
	BLE HID iCLASS: Wireless convertible - standard square spindles, finishes and handles.	829,50
	BLE HID iCLASS: Wireless convertible - 9mm square spindle, finishes and handles.	864,10
	BLE HID iCLASS: Wireless - standard square spindles, finishes and handles.	946,90
	BLE HID iCLASS: Wireless - 9mm square spindle, finishes and handles.	981,40

Model Ex653xK

SALTO XS4 Electronic Escutcheon Ex653, with keypad, 2 Handles, any type, Inside cylinder cut out.

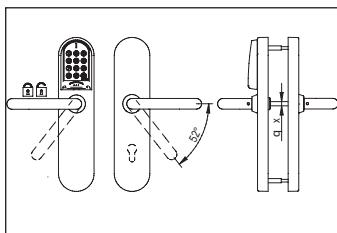

BLE MIFARE - DESFire
BLE HID iCLASS

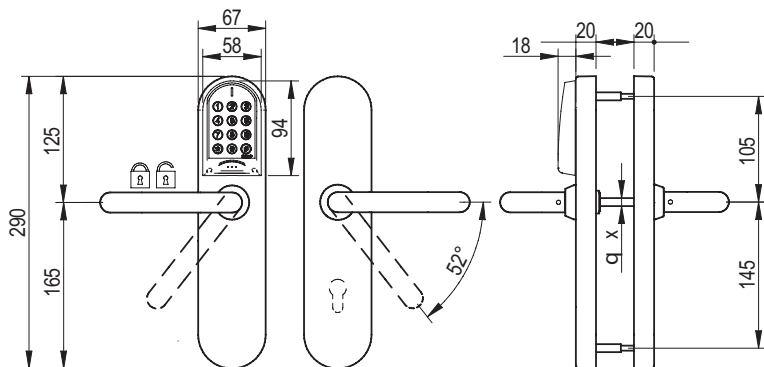

Technology	Escutcheon width	Function	Handle	Handle to thumbturn	Finish	Door thickness	Square spindle	Handing	Wireless option	Keypad option	Gain durability
EB BLE MIFARE DESFire	6	53	U	47	IM	2 Fo = 15-17,5mm	7 7mm	-	-	K	-
			L	48				-			
			W	49				-			
			H ²	55	IP ²	3 32-47 mm	8 8mm	-			
			Y ²	62				-			
			S ^{1,2}	70				R/L ¹			
			B ²	72	PP	4 45-60mm	9 9mm	-			
			P ²	78				-			
			O ¹	7F	PM	5 Fo = 20-22,5mm	S 8mm split	R/L ¹			
			J	3R				-			
T	4R	-									
EJ BLE HID iCLASS	6	53	Z	7R	IA	6 60-75mm	V 9mm split	-	Convertible Wireless	G Gain durability	
			G	85				-			
			N	88	NE ²	7 75-90mm	6 7,6mm split	R/L ¹			
			K ¹	90				-			
			2 ²	92				-			
			3 ²	9R	BC ² BioCote	9 90-105mm Fo = 16.5 - 59mm	1 105-120mm Fo = 30.5 - 89mm	-			
			4 ²	10				-			
			5 ²	11				-			

Additional Prices - Gross prices



¹ For Handed lever handles, only for S, O or K handles.

² This option has an additional price please refer to the handles or finishes chapter.

Ref	Remarks	€
G	Gain durability	21,30

<p style="font-size: 1.2em; font-weight: bold;">Model Ex653xK</p>	<p>SALTO XS4 Electronic Escutcheon Ex653, with keypad, 2 Handles, any type, Inside cylinder cut out.</p>
---	--

Prices - Gross prices	€
------------------------------	---



BLE MIFARE DESFire: Standard - standard square spindles, finishes and handles.	618,25
BLE MIFARE DESFire: Standard - 9mm square spindle, finishes and handles.	652,95
BLE MIFARE DESFire: Wireless convertible - standard square spindles, finishes and handles.	665,00
BLE MIFARE DESFire: Wireless convertible - 9mm square spindle, finishes and handles.	699,60
BLE MIFARE DESFire: Wireless - standard square spindles, finishes and handles.	782,35
BLE MIFARE DESFire: Wireless - 9mm square spindle, finishes and handles.	816,90



BLE HID iCLASS: Standard - standard square spindles, finishes and handles.	778,95
BLE HID iCLASS: Standard - 9mm square spindle, finishes and handles.	813,55
BLE HID iCLASS: Wireless convertible - standard square spindles, finishes and handles.	825,65
BLE HID iCLASS: Wireless convertible - 9mm square spindle, finishes and handles.	860,25
BLE HID iCLASS: Wireless - standard square spindles, finishes and handles.	942,85
BLE HID iCLASS: Wireless - 9mm square spindle, finishes and handles.	977,50

Model Ex654xK SALTO XS4 Electronic Escutcheon Ex654, with keypad, 2 Handles, any type, Outside cylinder cut out.

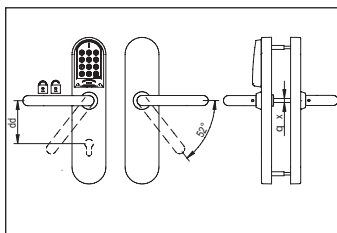

BLE MIFARE - DESFire
BLE HID iCLASS

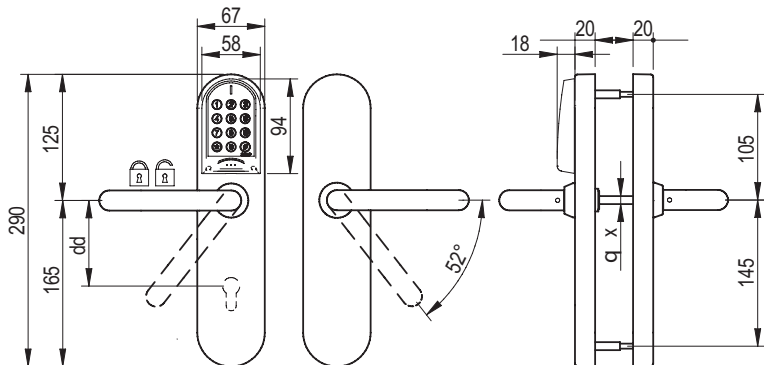

Technology	Escutcheon width	Function	Handle	Handle to thumbturn	Finish	Door thickness	Square spindle	Handing	Wireless option	Keypad option	Gain durability
EB BLE MIFARE DESFire	6	54	U	70	IM	2 <i>Fo = 15-17,5mm</i>	7 7mm	-	-	K	-
			L	72				-			
			W					-			
			H ²	7F	IP ²	3 32-47 mm	-				
			Y ²	78		A <i>Fo = 17.5 -20mm</i>	-				
			S ^{1,2}				R/L ¹				
			B ²	85	PP	4 45-60mm	-				
			P ²	88			-				
			O ¹	90			9 9mm	R/L ¹			
			J		PM	B <i>Fo = 20-22,5mm</i>		-			
T	S 8mm split	-									
Z		10	6 60-75mm	-							
G				V 9mm split	R/L ¹						
N	11				7 75-90mm	-					
K ¹		NE ²	9 90-105mm <i>Fo = 16.5 -59mm</i>			-					
2 ²				W		6 7,6mm split	-				
3 ²	BC ² BioCote				1 105-120mm <i>Fo = 30.5 - 89mm</i>		-				
4 ²		-									
5 ²		-									
7 ²	9R	-									

Additional Prices - Gross prices



¹ For Handed lever handles, only for S, O or K handles.



² This option has an additional price please refer to the handles or finishes chapter.

Ref	Remarks	€
G	Gain durability	21,30

<p style="font-size: 1.2em; font-weight: bold;">Model Ex654xK</p>	<p>SALTO XS4 Electronic Escutcheon Ex654, with keypad, 2 Handles, any type, Outside cylinder cut out.</p>
---	---

Prices - Gross prices	€
------------------------------	---

	MIFARE DESFire	BLE MIFARE DESFire: Standard - standard square spindles, finishes and handles.	618,25
	BLE MIFARE DESFire: Standard - 9mm square spindle, finishes and handles.	652,95	
	BLE MIFARE DESFire: Wireless convertible - standard square spindles, finishes and handles.	665,00	
	BLE MIFARE DESFire: Wireless convertible - 9mm square spindle, finishes and handles.	699,60	
	BLE MIFARE DESFire: Wireless - standard square spindles, finishes and handles.	782,35	
	BLE MIFARE DESFire: Wireless - 9mm square spindle, finishes and handles.	816,90	

 	iCLASS for HID	BLE HID iCLASS: Standard - standard square spindles, finishes and handles.	778,95
	BLE HID iCLASS: Standard - 9mm square spindle, finishes and handles.	813,55	
	BLE HID iCLASS: Wireless convertible - standard square spindles, finishes and handles.	825,65	
	BLE HID iCLASS: Wireless convertible - 9mm square spindle, finishes and handles.	860,25	
	BLE HID iCLASS: Wireless - standard square spindles, finishes and handles.	942,85	
	BLE HID iCLASS: Wireless - 9mm square spindle, finishes and handles.	977,50	

Model Ex656xK

SALTO XS4 Electronic Escutcheon Ex656, with keypad, 2 Handles, any type, Electronic “do not disturb” system.

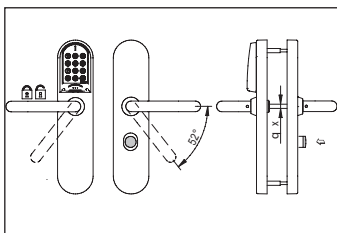

BLE MIFARE - DESFire
BLE HID iCLASS

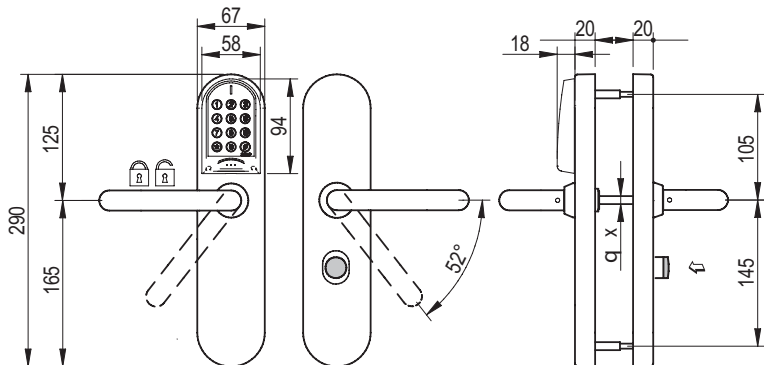

Technology	Escutcheon width	Function	Handle	Handle to thumbturn	Finish	Door thickness	Square spindle	Handing	Wireless option	Keypad option	Gain durability
EB BLE MIFARE DESFire	6	56	U	00 without distance	IM	2 Fo = 15-17,5mm	7 7mm	-	-	K	-
			L			-					
			W			-					
			H ²			-					
			Y ²		IP ²	3 32-47 mm	-				
			S ^{1,2}			A Fo = 17.5 -20mm	R/L ¹				
			B ²		PP	4 45-60mm	-				
			P ²			-					
			O ¹		PM	9 9mm	R/L ¹				
			J			B Fo = 20-22,5mm	-				
EJ BLE HID iCLASS	6	56	T	7F 72mm for fire doors	PM	5 Fo = 22.5-25mm	S 8mm split	-	C Convertible	K	G Gain durability
			Z			-					
			G		IA	6 60-75mm	-				
			N			-					
			K ¹		NE ²	7 75-90mm	R/L ¹				
			2 ²			-					
			3 ²		BC ² BioCote	9 90-105mm Fo = 16.5 -59mm	-	W Wireless			
			4 ²			6 7,6mm split	-				
			5 ²			1 105-120mm Fo = 30.5 - 89mm	-				
			7 ²		-	-					

Additional Prices - Gross prices



¹ For Handed lever handles, only for S, O or K handles.

² This option has an additional price please refer to the handles or finishes chapter.

Ref	Remarks	€
G	Gain durability	21,30

Model Ex656xK	SALTO XS4 Electronic Escutcheon Ex656, with keypad, 2 Handles, any type, Electronic “do not disturb” system.
----------------------	--

Prices - Gross prices	€
------------------------------	----------

	BLE MIFARE DESFire: Standard - standard square spindles, finishes and handles.	652,80
	BLE MIFARE DESFire: Standard - 9mm square spindle, finishes and handles.	687,45
	BLE MIFARE DESFire: Wireless convertible - standard square spindles, finishes and handles.	699,45
	BLE MIFARE DESFire: Wireless convertible - 9mm square spindle, finishes and handles.	734,05
	BLE MIFARE DESFire: Wireless - standard square spindles, finishes and handles.	816,75
	BLE MIFARE DESFire: Wireless - 9mm square spindle, finishes and handles.	851,35

	BLE HID iCLASS: Standard - standard square spindles, finishes and handles.	806,25
	BLE HID iCLASS: Standard - 9mm square spindle, finishes and handles.	840,90
	BLE HID iCLASS: Wireless convertible - standard square spindles, finishes and handles.	852,70
	BLE HID iCLASS: Wireless convertible - 9mm square spindle, finishes and handles.	887,30
	BLE HID iCLASS: Wireless - standard square spindles, finishes and handles.	970,20
	BLE HID iCLASS: Wireless - 9mm square spindle, finishes and handles.	1004,80

Model Ex657xK

SALTO XS4 Electronic Escutcheon Ex657, with keypad, 2 Handles, any type, Outside cylinder cut out, Electronic “do not disturb” system.

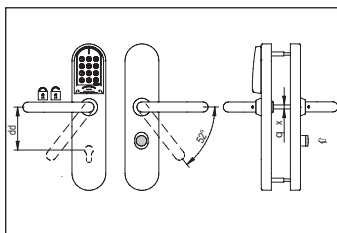

BLE MIFARE - DESFire
BLE HID iCLASS

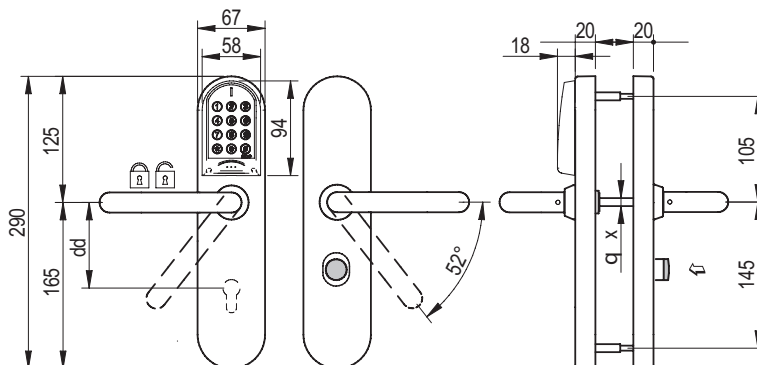

Technology	Escutcheon width	Function	Handle	Handle to thumbturn	Finish	Door thickness	Square spindle	Handing	Wireless option	Keypad option	Gain durability
EB BLE MIFARE DESFire	6	57	U	70	IM	2 Fo = 15-17,5mm	7 7mm	-	-	K	-
			L	72				-			
			W					-			
			H ²	7F	IP ²	3 32-47 mm	8 8mm	-			
			Y ²	78		-					
			S ^{1,2}			A Fo = 17.5 -20mm		R/L ¹			
			B ²	85	PP	4 45-60mm	9 9mm	-			
			P ²	88				-			
			O ¹	90				R/L ¹			
			EJ BLE HID iCLASS	6	57	J	90	PM			
T	92	-									
Z	10	IA				6 60-75mm	V 9mm split	-			
G								-			
N	11	NE ²				7 75-90mm	6 7,6mm split	R/L ¹			
K ¹	3R							-			
2 ²	4R							-			
3 ²	7R	BC ² BioCote				9 90-105mm Fo = 16.5 -59mm	6	-			
4 ²			-								
5 ²			-								
7 ²	9R	1 105-120mm Fo = 30.5 - 89mm	-	W Wireless	-						

Additional Prices - Gross prices



¹ For Handed lever handles, only for S, O or K handles.

² This option has an additional price please refer to the handles or finishes chapter.

Ref	Remarks	€
G	Gain durability	21,30

European wide body escutcheon with keypad

Model Ex657xK

SALTO XS4 Electronic Escutcheon Ex657, with keypad, 2 Handles, any type, Outside cylinder cut out, Electronic “do not disturb” system.

Prices - Gross prices

€



**MIFARE
DESFire**

BLE MIFARE DESFire: Standard - standard square spindles, finishes and handles.	652,80
BLE MIFARE DESFire: Standard - 9mm square spindle, finishes and handles.	687,45
BLE MIFARE DESFire: Wireless convertible - standard square spindles, finishes and handles.	699,45
BLE MIFARE DESFire: Wireless convertible - 9mm square spindle, finishes and handles.	734,05
BLE MIFARE DESFire: Wireless - standard square spindles, finishes and handles.	816,75
BLE MIFARE DESFire: Wireless - 9mm square spindle, finishes and handles.	851,35



BLE HID iCLASS: Standard - standard square spindles, finishes and handles.	806,25
BLE HID iCLASS: Standard - 9mm square spindle, finishes and handles.	840,90
BLE HID iCLASS: Wireless convertible - standard square spindles, finishes and handles.	852,70
BLE HID iCLASS: Wireless convertible - 9mm square spindle, finishes and handles.	887,30
BLE HID iCLASS: Wireless - standard square spindles, finishes and handles.	970,20
BLE HID iCLASS: Wireless - 9mm square spindle, finishes and handles.	1004,80

Model Ex658xK

SALTO XS4 Electronic Escutcheon Ex658, with keypad, 2 Handles, any type, inside thumbturn 90°, with connector for mortise lock with micro-switch.

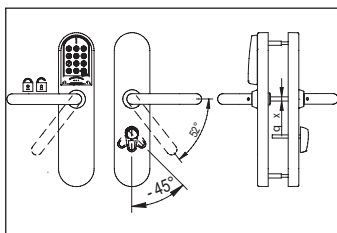

BLE MIFARE - DESFire
BLE HID iCLASS

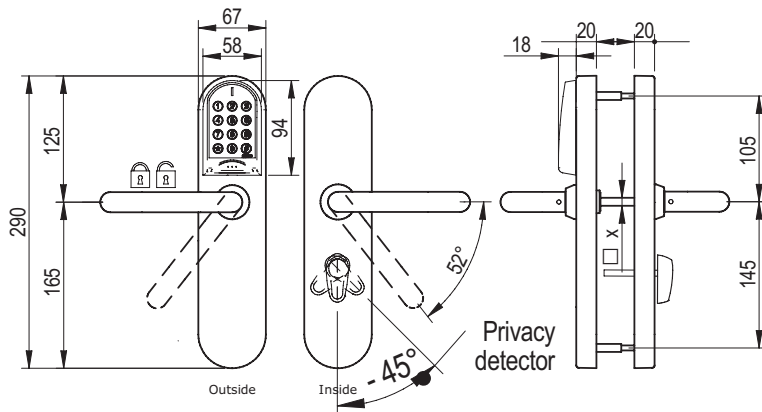

Technology	Escutcheon width	Function	Handle	Handle to thumbturn	Finish	Door thickness	Square spindle	Handing	Wireless option	Keypad option	Gain durability
EB BLE MIFARE DESFire	6	58	U	62	IM	3 32-47 mm	7 7mm	-	-	K	-
			L					-			
			W					-			
			H ²		IP ²	4 45-60mm	-				
			Y ²				-				
			S ^{1,2}		PP	6 60-75mm	R/L ¹				
			B ²				-				
			P ²				-				
			O ¹		PM	7 75-90mm	R/L ¹				
			J				-				
T	-										
EJ BLE HID iCLASS	6	58	Z	62	IA	7 75-90mm	9 9mm	-	C Convertible	K	G Gain durability
			G					-			
			N		NE ²	9 90-105mm	R/L ¹				
			K ¹				-				
			2 ²				-				
			3 ²		V	1 105-120mm	9mm split	-			
			4 ²					-			
5 ²	-										
7 ²	-										

Additional Prices - Gross prices



¹ For Handed lever handles, only for S, O or K handles.

² This option has an additional price please refer to the handles or finishes chapter.

Ref	Remarks	€
G	Gain durability	21,30

Model Ex658xK

SALTO XS4 Electronic Escutcheon Ex658, with keypad, 2 Handles, any type, inside thumbturn 90°, with connector for mortise lock with micro-switch.

Prices - Gross prices

€



BLE MIFARE DESFire: Standard - standard square spindles, finishes and handles.	670,15
BLE MIFARE DESFire: Standard - 9mm square spindle, finishes and handles.	704,75
BLE MIFARE DESFire: Wireless convertible - standard square spindles, finishes and handles.	716,85
BLE MIFARE DESFire: Wireless convertible - 9mm square spindle, finishes and handles.	751,35
BLE MIFARE DESFire: Wireless - standard square spindles, finishes and handles.	834,05
BLE MIFARE DESFire: Wireless - 9mm square spindle, finishes and handles.	868,75



BLE HID iCLASS: Standard - standard square spindles, finishes and handles.	806,25
BLE HID iCLASS: Standard - 9mm square spindle, finishes and handles.	840,90
BLE HID iCLASS: Wireless convertible - standard square spindles, finishes and handles.	852,70
BLE HID iCLASS: Wireless convertible - 9mm square spindle, finishes and handles.	887,30
BLE HID iCLASS: Wireless - standard square spindles, finishes and handles.	970,20
BLE HID iCLASS: Wireless - 9mm square spindle, finishes and handles.	1004,80

Model Ex6P0xK

SALTO XS4 Electronic Escutcheon Ex6P0 or Ex660 with keypad
2 Handles, any type, built in mechanical cylinder with audit housing,
(mechanical cylinder not included, for technical specifications consult SALTO).

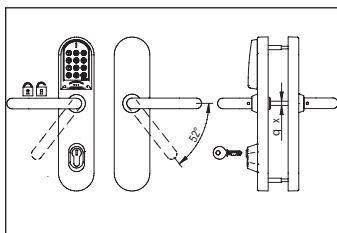

BLE MIFARE - DESFire
BLE HID iCLASS

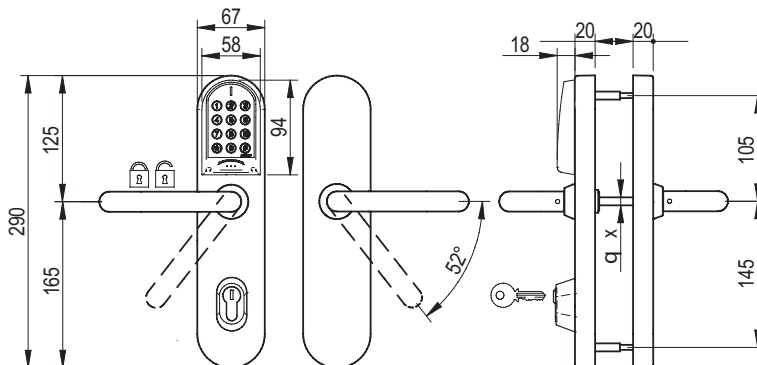

Technology	Escutcheon width	Function	Handle	Handle to thumbturn	Finish	Door thickness	Square spindle	Handing	Wireless option	Keypad option	Gain durability
EB BLE MIFARE DESFire	6	60 Mortise cylinder 1-1/8"	U	00 without distance	IM	2 Fo = 15-17,5mm	7 7mm	-	-	K	-
			L			3 32-47 mm		-			
			W				8 8mm	-			
			H ²			A Fo = 17.5 -20mm		R/L ¹			
			Y ²		PP		4 45-60mm	-			
			S ^{1,2}			9 9mm		R/L ¹			
			B ²				5 Fo = 20-22,5mm	-			
			P ²			S 8mm split		-			
			O ¹		PM		6 60-75mm	-			
			J			V 9mm split		R/L ¹			
EJ BLE HID iCLASS	6	P0 Euro profile cylinder 30-10	T	00 without distance	IA		7 75-90mm	6 7,6mm split	-	C Convertible	W Wireless
			Z			9 90-105mm Fo = 16.5 -59mm			-		
			G		BC ² BioCote		1 105-120mm Fo = 30.5 - 89mm	-			
			N			-					
			K ¹		-						
			2 ²		-						
			3 ²		-						
4 ²	-										
5 ²	-										
7 ²	-										



¹ For Handed lever handles, only for S, O or K handles.

² This option has an additional price please refer to the handles or finishes chapter.

Cylinders for the override

Model P

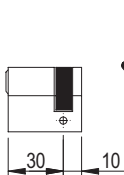

Model 6
Mortise cylinder

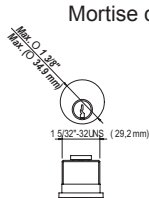

Additional Prices - Gross prices

Ref	Remarks	€
G	Gain durability	21,30

European wide body escutcheon with keypad

Model Ex6P0xK

SALTO XS4 Electronic Escutcheon Ex6P0 or Ex660 with keypad
2 Handles, any type, built in mechanical cylinder with audit housing,
(mechanical cylinder not included, for technical specifications consult SALTO).

Prices - Gross prices

€



**MIFARE
DESFire**

BLE MIFARE DESFire: Standard - standard square spindles, finishes and handles.	629,15
BLE MIFARE DESFire: Standard - 9mm square spindle, finishes and handles.	663,80
BLE MIFARE DESFire: Wireless convertible - standard square spindles, finishes and handles.	675,85
BLE MIFARE DESFire: Wireless convertible - 9mm square spindle, finishes and handles.	710,40
BLE MIFARE DESFire: Wireless - standard square spindles, finishes and handles.	793,10
BLE MIFARE DESFire: Wireless - 9mm square spindle, finishes and handles.	827,70



BLE HID iCLASS: Standard - standard square spindles, finishes and handles.	774,30
BLE HID iCLASS: Standard - 9mm square spindle, finishes and handles.	809,00
BLE HID iCLASS: Wireless convertible - standard square spindles, finishes and handles.	820,90
BLE HID iCLASS: Wireless convertible - 9mm square spindle, finishes and handles.	855,50
BLE HID iCLASS: Wireless - standard square spindles, finishes and handles.	938,30
BLE HID iCLASS: Wireless - 9mm square spindle, finishes and handles.	972,90

Model Ex6P1xK

SALTO XS4 Electronic Escutcheon Ex6P1 or Ex661with keypad, 2 Handles, any type, inside thumbturn, built in mechanical cylinder with audit housing, (mechanical cylinder not included, for technical specifications consult SALTO).

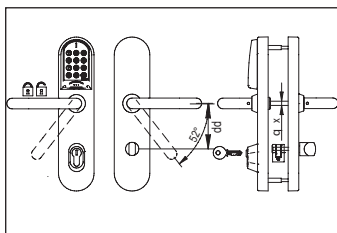

BLE MIFARE - DESFire
BLE HID iCLASS

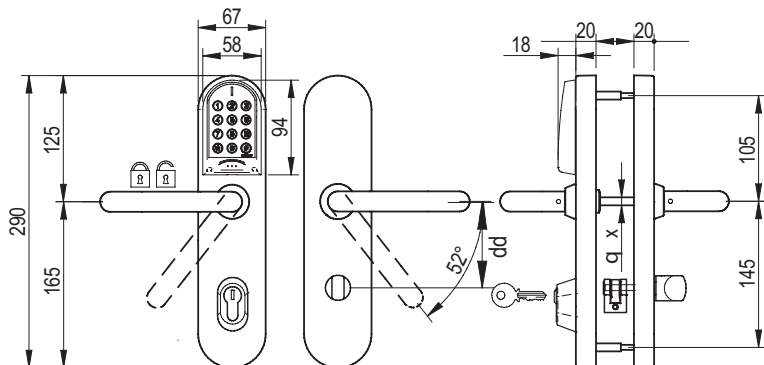

Technology	Escutcheon width	Function	Handle	Handle to thumbturn	Finish	Door thickness	Square spindle	Handing	Wireless option	Keypad option	Gain durability
EB BLE MIFARE DESFire	6	61 Mortise cylinder 1-1/8"	U	47	IM	3 32-47 mm	7 7mm	-	-	K	-
			L	48				-			
			W	49				-			
			H ²	55	IP ²	4 45-60mm	-				
			Y ²	62			-				
			S ^{1,2}	70	PP	6 60-75mm	R/L ¹				
			B ²	72			-				
			P ²	78			-				
			O ¹	78			-				
			J	3R	PM	9 9mm	R/L ¹	C Convertible			
T	4R	-									
EJ BLE HID iCLASS	6	P1 Euro profile cylinder 30-10	Z	7R	IA	7 75-90mm	-	W Wireless	G Gain durability		
			G	85			-				
			N	88	NE ²	9 90-105mm	-				
			K ¹	90			R/L ¹				
			2 ²	92			-				
			3 ²	9R	BC ² BioCote	1 105-120mm	-				
			4 ²	10			-				
			5 ²	10			-				
7 ²	11	-									



¹ For Handed lever handles, only for S, O or K handles.

² This option has an additional price please refer to the handles or finishes chapter.

³ Not available in BLE Mifare DESFire.

Cylinders for the override

Model P

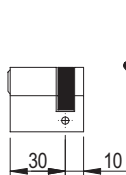

Model 6
Mortise cylinder

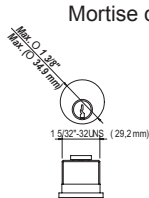

Additional Prices - Gross prices

Ref	Remarks	€
G	Gain durability	21,30

Model Ex6P1xK

SALTO XS4 Electronic Escutcheon Ex6P1 or Ex661with keypad, 2 Handles, any type, inside thumbturn, built in mechanical cylinder with audit housing, (mechanical cylinder not included, for technical specifications consult SALTO).

Prices - Gross prices

€



BLE MIFARE DESFire: Standard - standard square spindles, finishes and handles.	678,85
BLE MIFARE DESFire: Standard - 9mm square spindle, finishes and handles.	713,55
BLE MIFARE DESFire: Wireless convertible - standard square spindles, finishes and handles.	725,55
BLE MIFARE DESFire: Wireless convertible - 9mm square spindle, finishes and handles.	760,10
BLE MIFARE DESFire: Wireless - standard square spindles, finishes and handles.	842,90
BLE MIFARE DESFire: Wireless - 9mm square spindle, finishes and handles.	877,65



BLE HID iCLASS: Standard - standard square spindles, finishes and handles.	815,00
BLE HID iCLASS: Standard - 9mm square spindle, finishes and handles.	849,65
BLE HID iCLASS: Wireless convertible - standard square spindles, finishes and handles.	861,55
BLE HID iCLASS: Wireless convertible - 9mm square spindle, finishes and handles.	896,10
BLE HID iCLASS: Wireless - standard square spindles, finishes and handles.	979,10
BLE HID iCLASS: Wireless - 9mm square spindle, finishes and handles.	1013,65

Model Ex6P6xK

SALTO XS4 Electronic Escutcheon Ex6P6 or Ex666 with keypad
 2 Handles, any type, electronic "do not disturb" system, built in mechanical cylinder with audit housing, (mechanical cylinder not included, for technical specifications consult SALTO)

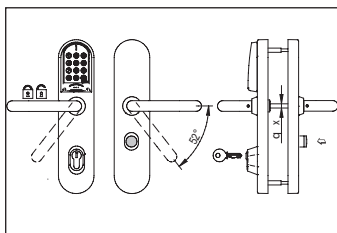

BLE MIFARE - DESFire
 BLE HID iCLASS

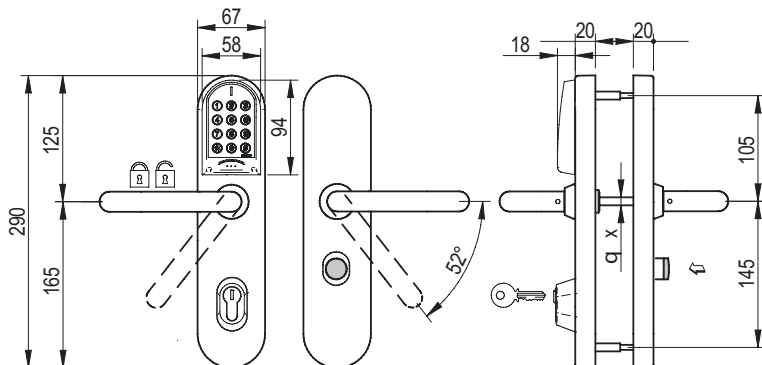

Technology	Escutcheon width	Function	Handle	Handle to thumbturn	Finish	Door thickness	Square spindle	Handing	Wireless option	Keypad option	Gain durability
EB BLE MIFARE DESFire	6	66 Mortise cylinder 1-1/8"	U	00 without distance	IM	2 Fo = 15-17,5mm	7 7mm	-	-	K	-
			L			3 32-47 mm		-			
			W				8 8mm	-			
			H ²			A Fo = 17.5 -20mm		R/L ¹			
			Y ²		PP		4 45-60mm	-			
			S ^{1,2}			9 9mm		R/L ¹			
			B ²				9 9mm	-			
			P ²			S 8mm split		-			
			O ¹		PM		5 Fo = 22.5-25mm	-			
			J			IA		6 60-75mm			
EJ BLE HID iCLASS	P6 Euro profile cylinder 30-10	T	00 without distance	NE ²	7 75-90mm		V 9mm split		R/L ¹	C Convertible	W Wireless
		Z				9 90-105mm Fo = 16.5 -59mm		-			
		G		6 7,6mm split	-						
		N			1 105-120mm Fo = 30.5 - 89mm	-					
		K ¹		BC ² BioCote		1 105-120mm Fo = 30.5 - 89mm	-				
		2 ²			-						
		3 ²		-							
4 ²	-										
5 ²	-										
7 ²	-										



¹ For Handed lever handles, only for S, O or K handles.

² This option has an additional price please refer to the handles or finishes chapter.

³ Not available in BLE Mifare DESFire.

Cylinders for the override

Model P

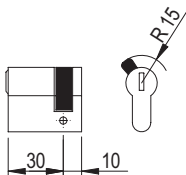

Model 6
Mortise cylinder

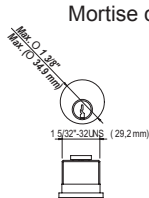



Additional Prices - Gross prices

Ref	Remarks	€
G	Gain durability	21,30

Model Ex6P6xK

SALTO XS4 Electronic Escutcheon Ex6P6 or Ex666 with keypad
 2 Handles, any type, electronic “do not disturb” system, built in mechanical cylinder with audit housing, (mechanical cylinder not included, for technical specifications consult SALTO)

Prices - Gross prices		€
	BLE MIFARE DESFire: Standard - standard square spindles, finishes and handles.	661,55
	BLE MIFARE DESFire: Standard - 9mm square spindle, finishes and handles.	696,20
	BLE MIFARE DESFire: Wireless convertible - standard square spindles, finishes and handles.	708,20
	BLE MIFARE DESFire: Wireless convertible - 9mm square spindle, finishes and handles.	742,80
	BLE MIFARE DESFire: Wireless - standard square spindles, finishes and handles.	825,50
	BLE MIFARE DESFire: Wireless - 9mm square spindle, finishes and handles.	860,10
	BLE HID iCLASS: Standard - standard square spindles, finishes and handles.	815,00
	BLE HID iCLASS: Standard - 9mm square spindle, finishes and handles.	849,65
	BLE HID iCLASS: Wireless convertible - standard square spindles, finishes and handles.	861,55
	BLE HID iCLASS: Wireless convertible - 9mm square spindle, finishes and handles.	896,10
	BLE HID iCLASS: Wireless - standard square spindles, finishes and handles.	979,10
	BLE HID iCLASS: Wireless - 9mm square spindle, finishes and handles.	1013,65

Model Ex6P8xK

SALTO XS4 Electronic Escutcheon Ex6P8 or Ex668 with keypad
 2 Handles, any type, inside thumbturn 90°, with connector for mortise lock
 with micro-switch (mechanical cylinder not included, for technical specifications consult SALTO).

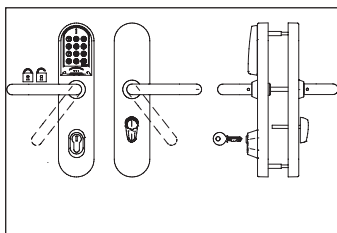

BLE MIFARE - DESFire
 BLE HID iCLASS

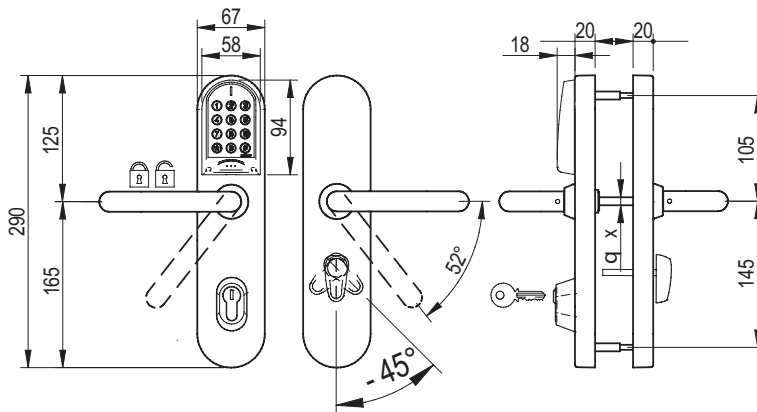

Technology	Escutcheon width	Function	Handle	Handle to thumbturn	Finish	Door thickness	Square spindle	Handing	Wireless option	Keypad option	Gain durability
EB BLE MIFARE DESFire	6	68 Mortise cylinder 1-1/8"	U	62	IM	3 32-47 mm	7 7mm	-	-	K	-
			L					-			
			W					-			
			H ²		IP ²	4 45-60mm	-				
			Y ²				-				
			S ^{1,2}				R/L ¹				
			B ²		PP	6 60-75mm	-				
			P ²				-				
			O ¹				R/L ¹				
			J		PM	7 75-90mm	-				
T	-										
Z	-										
EJ BLE HID iCLASS	6	P8 Euro profile cylinder 30-10	G	62	IA	9 90-105mm	9 9mm	-	C Convertible	K	G Gain durability
			N					-			
			K ¹		NE ²	9 90-105mm	8mm split	R/L ¹			
			2 ²					-			
			3 ²		BC ² BioCote	1 105-120mm	V 9mm split	-			
			4 ²					-			
			5 ²					-			
			7 ²		-						



¹ For Handed lever handles, only for S, O or K handles.

² This option has an additional price please refer to the handles or finishes chapter.

³ Not available in BLE Mifare DESFire.

Cylinders for the override

Model P

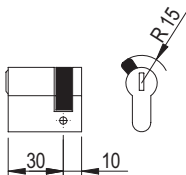

Model 6
Mortise cylinder

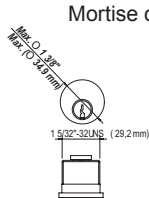

Additional Prices - Gross prices

Ref	Remarks	€
G	Gain durability	21,30

European wide body escutcheon with keypad

Model Ex6P8xK

SALTO XS4 Electronic Escutcheon Ex6P8 or Ex668 with keypad
 2 Handles, any type, inside thumbturn 90°, with connector for mortise lock
 with micro-switch (mechanical cylinder not included, for technical specifications consult SALTO).

Prices - Gross prices

€



**MIFARE
 DESFire**

BLE MIFARE DESFire: Standard - standard square spindles, finishes and handles.	678,85
BLE MIFARE DESFire: Standard - 9mm square spindle, finishes and handles.	713,55
BLE MIFARE DESFire: Wireless convertible - standard square spindles, finishes and handles.	725,55
BLE MIFARE DESFire: Wireless convertible - 9mm square spindle, finishes and handles.	760,10
BLE MIFARE DESFire: Wireless - standard square spindles, finishes and handles.	842,90
BLE MIFARE DESFire: Wireless - 9mm square spindle, finishes and handles.	877,65



BLE HID iCLASS: Standard - standard square spindles, finishes and handles.	815,00
BLE HID iCLASS: Standard - 9mm square spindle, finishes and handles.	849,65
BLE HID iCLASS: Wireless convertible - standard square spindles, finishes and handles.	861,55
BLE HID iCLASS: Wireless convertible - 9mm square spindle, finishes and handles.	896,10
BLE HID iCLASS: Wireless - standard square spindles, finishes and handles.	979,10
BLE HID iCLASS: Wireless - 9mm square spindle, finishes and handles.	1013,65

Model Ax650

SALTO XS4 Electronic Escutcheon Ax650,
For ANSI mortise locks, 2 handles, any type.

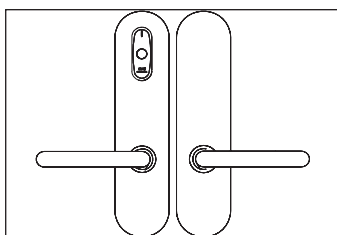

Inside Picopass
LEGIC advant - Prime
Mifare - DESFire
BLE Mifare DESFire
HID iCLASS
BLE HID iCLASS

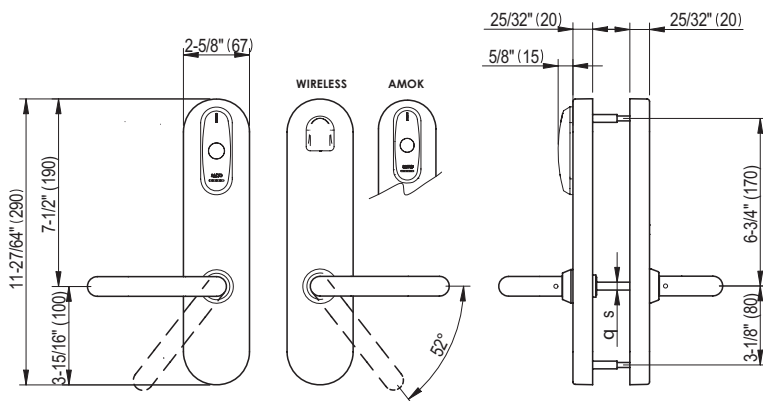

Technology	Escutcheon width	Function	Handle	Handle to thumbturn	Finish	Door thickness	Square spindle	Handing	Wireless option	Gain durability								
A7 PICOPASS	6	50	U	00 without distance	IM	2 Fo = 15-17,5mm	8 8mm	-	-	-								
			A					-										
			L					-										
			W					-										
A8 LEGIC			H ²		IP ²	3 32-47 mm	A Fo = 17.5 -20mm	D ⁴ 7mm diamond			-							
											A9 MIFARE	B ²	PP	4 45-60mm	S 8mm split	R/L ¹		
																O ¹	B Fo = 20-22,5mm	-
AB MIFARE BLE			J		PM	5 Fo = 22.5-25mm	IA	6 60-75mm			U 7mm diamond split	-						
												AH HID iCLASS	N	K ¹	7 75-90mm	NE ²	R/L ¹	
																	AJ BLE HID iCLASS	2 ²
												3 ²	6 7,6mm split	-				
AJ BLE HID iCLASS			4 ²		6	7	U	7mm diamond split			R/L ¹	-						
												5 ²	6	7,6mm split	A ³	Amok		
																	7 ²	1

Additional Prices - Gross prices



¹ For handed lever handles, only for S, O or K handles.

² This option has an additional price please refer to the handles or finishes chapter.

³ Not available in BLE Mifare DESFire.

⁴ Only for A handle.

Ref	Remarks	€
G	Gain durability	21,30

Model Ax650	SALTO XS4 Electronic Escutcheon Ax650, For ANSI mortise locks, 2 handles, any type.
--------------------	--

Prices - Gross prices	€
------------------------------	---



Picopass: Standard - standard square spindles, finishes and handles.	518,50
Picopass: Wireless convertible - standard square spindles, finishes and handles.	557,40
Picopass: Wireless - standard square spindles, finishes and handles.	655,15
Picopass: Amok - standard square spindles, finishes and handles.	688,50



Legic: Standard - standard square spindles, finishes and handles.	493,95
Legic: Wireless convertible - standard square spindles, finishes and handles.	532,65
Legic: Wireless - standard square spindles, finishes and handles.	630,55
Legic: Amok - standard square spindles, finishes and handles.	619,05



Mifare DESFire: Standard - standard square spindles, finishes and handles.	493,95
Mifare DESFire: Wireless convertible - standard square spindles, finishes and handles.	532,65
Mifare DESFire: Wireless - standard square spindles, finishes and handles.	630,55
Mifare DESFire: Amok - standard square spindles, finishes and handles.	619,05



BLE Mifare DESFire: additional price to add to the Mifare DESFire price. Gross price	27,70
--	--------------



HID iCLASS: Standard - standard square spindles, finishes and handles.	615,35
HID iCLASS: Wireless convertible - standard square spindles, finishes and handles.	654,25
HID iCLASS: Wireless - standard square spindles, finishes and handles.	751,95
HID iCLASS: Amok - standard square spindles, finishes and handles.	896,60



BLE HID iCLASS: additional price to add to the HID iCLASS price. Gross price	27,70
--	--------------

Model Ax656

SALTO XS4 Electronic Escutcheon Ax656,
For ANSI mortise locks, 2 Handles, any type, Electronic “do not disturb” system.

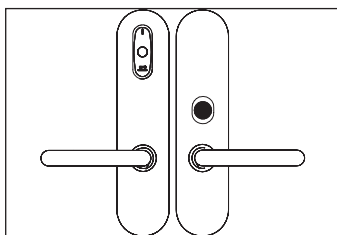

Inside Picopass
LEGIC advant - Prime
Mifare - DESFire
BLE Mifare DESFire
HID iCLASS
BLE HID iCLASS

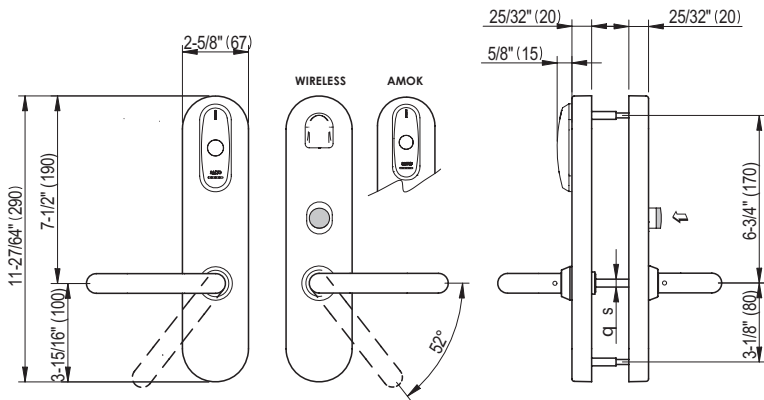

Technology	Escutcheon width	Function	Handle	Handle to thumbturn	Finish	Door thickness	Square spindle	Handing	Wireless option	Gain durability				
A7 Prox. Picopass	6	56	U	00 without distance	IM	2 Fo = 15-17,5mm	8 8mm	-	-	-				
			A					-						
			L					-						
			W					-						
A8 Prox. Legic			H ²		Y ²	S ^{1,2}	B ²	IP ²			3 32-47 mm	D ⁴ 7mm diamond	-	
													P ²	R/L ¹
													O ¹	-
													J	R/L ¹
A9 Prox. Mifare			T		Z	G	N	PM			5 Fo = 22.5-25mm	S 8mm split	-	
													K ¹	-
													2 ²	-
													3 ²	-
AH Prox. HID iCLASS			4 ²		5 ²	7 ²	IA	6 60-75mm			7 75-90mm	U 7mm diamond split	-	
													NE ²	R/L ¹
													9 90-105mm Fo = 16.5 -59mm	-
													1 105-120mm Fo = 30.5 - 89mm	-
AB Prox. MIFARE BLE	BC ² BioCote	6 7,6mm split	105-120mm Fo = 30.5 - 89mm	1	7	9	6	-						
								2	-					
								3	-					
								4	-					

Additional Prices - Gross prices



¹ For handed lever handles, only for S, O or K handles.

² This option has an additional price please refer to the handles or finishes chapter.

³ Not available in BLE Mifare DESFire.

⁴ Only for A handle.

Ref	Remarks	€
G	Gain durability	21,30

Model Ax656

SALTO XS4 Electronic Escutcheon Ax656,
For ANSI mortise locks, 2 Handles, any type, Electronic “do not disturb” system.

Prices - Gross prices

€



Picopass: Standard - standard square spindles, finishes and handles.

546,90

Picopass: Wireless convertible - standard square spindles, finishes and handles.

585,85

Picopass: Wireless - standard square spindles, finishes and handles.

683,65

Picopass: Amok - standard square spindles, finishes and handles.

717,00



Legic: Standard - standard square spindles, finishes and handles.

520,90

Legic: Wireless convertible - standard square spindles, finishes and handles.

559,75

Legic: Wireless - standard square spindles, finishes and handles.

657,55

Legic: Amok - standard square spindles, finishes and handles.

646,10



Mifare DESFire: Standard - standard square spindles, finishes and handles.

520,90

Mifare DESFire: Wireless convertible - standard square spindles, finishes and handles.

559,75

Mifare DESFire: Wireless - standard square spindles, finishes and handles.

657,55

Mifare DESFire: Amok - standard square spindles, finishes and handles.

646,10



BLE Mifare DESFire: additional price to add to the Mifare DESFire price. **Gross price**

27,70



HID iCLASS: Standard - standard square spindles, finishes and handles.

649,30

HID iCLASS: Wireless convertible - standard square spindles, finishes and handles.

687,85

HID iCLASS: Wireless - standard square spindles, finishes and handles.

785,85

HID iCLASS: Amok - standard square spindles, finishes and handles.

930,50



BLE HID iCLASS: additional price to add to the HID iCLASS price. **Gross price**

27,70

Model Ax658

SALTO XS4 Electronic Escutcheon Ax658,
For ANSI mortise locks, 2 handles, any type, inside thumbturn 90°, with connector for mortise lock with micro-switch.

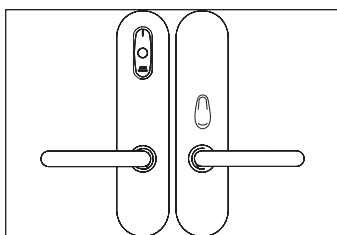

Inside Picopass
LEGIC advant - Prime
Mifare - DESFire
BLE Mifare DESFire
HID iCLASS
BLE HID iCLASS

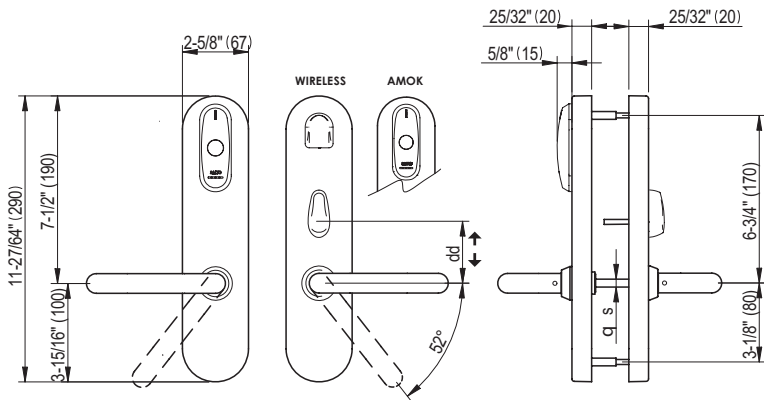

Technology	Escutcheon width	Function	Handle	Handle to thumbturn	Finish	Door thickness	Square spindle	Handing	Wireless option	Gain durability	
A7 PICOPASS	6	58	U	61 61mm	IM	3 32-47 mm	8 8mm	-	-	-	
			A					-			
			L					-			
A8 LEGIC			W			IP ²		4 45-60mm			-
			H ²								-
			Y ²								-
A9 MIFARE			B ²	PP	6 60-75mm	R/L ¹	C Convertible				
			P ²			-					
			O ¹			R/L ¹					
AB MIFARE BLE			J	PM	7 75-90mm	-		W Wireless			
			T			-					
			Z			-					
AH HID iCLASS	G	IA	9 90-105mm	-	G Gain durability						
	N			R/L ¹							
	K ¹			-							
AJ BLE HID iCLASS	2 ²	NE ²	1 105-120mm	-		A ³ Amok					
	3 ²			-							
	4 ²			-							
	5 ²			-							
	7 ²	BC ² BioCote		-							

Compatible with SALTO LA1T locks

Additional Prices - Gross prices



- ¹ For handed lever handles, only for S, O or K handles.
- ² This option has an additional price please refer to the handles or finishes chapter.
- ³ Not available in BLE Mifare DESFire.
- ⁴ Only for A handle.

Ref	Remarks	€
G	Gain durability	21,30

Model Ax658

SALTO XS4 Electronic Escutcheon Ax658,
For ANSI mortise locks, 2 handles, any type, inside thumbturn 90°, with
connector for mortise lock with micro-switch.

Prices - Gross prices

€



Picopass: Standard - standard square spindles, finishes and handles.

562,10

Picopass: Wireless convertible - standard square spindles, finishes and handles.

600,95

Picopass: Wireless - standard square spindles, finishes and handles.

698,65

Picopass: Amok - standard square spindles, finishes and handles.

732,00



Legic: Standard - standard square spindles, finishes and handles.

535,35

Legic: Wireless convertible - standard square spindles, finishes and handles.

574,20

Legic: Wireless - standard square spindles, finishes and handles.

672,00

Legic: Amok - standard square spindles, finishes and handles.

660,50



Mifare DESFire: Standard - standard square spindles, finishes and handles.

535,35

Mifare DESFire: Wireless convertible - standard square spindles, finishes and handles.

574,20

Mifare DESFire: Wireless - standard square spindles, finishes and handles.

672,00

Mifare DESFire: Amok - standard square spindles, finishes and handles.

660,50



BLE Mifare DESFire: additional price to add to the Mifare DESFire price. **Gross price**

27,70



HID iCLASS: Standard - standard square spindles, finishes and handles.

649,30

HID iCLASS: Wireless convertible - standard square spindles, finishes and handles.

687,85

HID iCLASS: Wireless - standard square spindles, finishes and handles.

785,85

HID iCLASS: Amok - standard square spindles, finishes and handles.

930,50



BLE HID iCLASS: additional price to add to the HID iCLASS price. **Gross price**

27,70

Model Ax660

SALTO XS4 Electronic Escutcheon Ax660,
For ANSI mortise locks, 2 handles, any type, built in mechanical cylinder with
audit housing, (mechanical cylinder not included, for technical specifications consult SALTO).

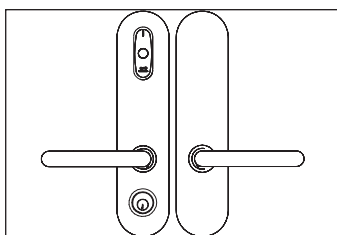

Inside Picopass
LEGIC advant - Prime
Mifare - DESFire
BLE Mifare DESFire
HID iCLASS
BLE HID iCLASS

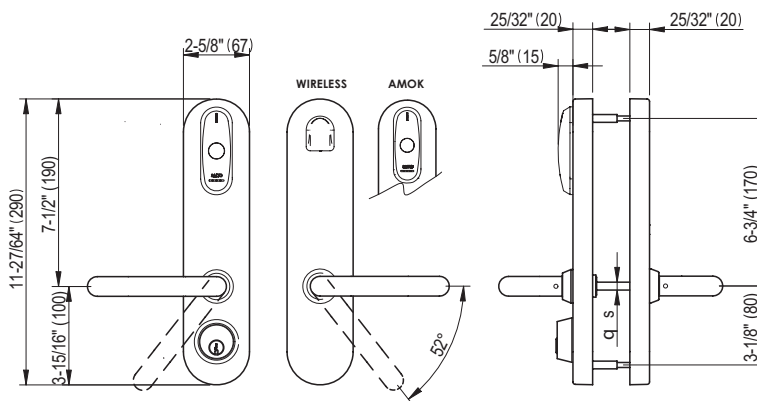

Technology	Escutcheon width	Function	Handle	Handle to thumbturn	Finish	Door thickness	Square spindle	Handing	Wireless option	Gain durability		
A7 PICOPASS	6	60	U	00 without distance	IM	2 Fo = 15-17,5mm	8 8mm	-	-			
			A					-				
			L					-				
A8 LEGIC			W		IP ²	3 32-47 mm	-					
			H ²				-					
			Y ²				-					
A9 MIFARE			S ^{1,2}		PP	4 45-60mm	D ⁴ 7mm diamond	-			R/L ¹	C Convertible
			B ²					-				
			P ²					-				
AB MIFARE BLE			O ¹		PM	5 Fo = 20-22,5mm	S 8mm split	-			R/L ¹	W Wireless
			J					-				
			T					-				
AH HID iCLASS	Z	IA	6 60-75mm	U 7mm diamond split	-	R/L ¹	G Gain durability					
	G				-							
	N				-							
AJ BLE HID iCLASS	K ¹	NE ²	7 75-90mm	6 7,6mm split	-	-	A ³ Amok					
	2 ²				-							
	3 ²				-							
	4 ²	BC ² BioCote	9 90-105mm Fo = 16.5 -59mm		-	-						
	5 ²				1 105-120mm Fo = 30.5 - 89mm	-						
	7 ²					-						



¹ For handed lever handles, only for S, O or K handles.

² This option has an additional price please refer to the handles or finishes chapter.

³ Not available in BLE Mifare DESFire.

⁴ Only for A handle.

Cylinders for the override

Model 6
Mortise cylinder

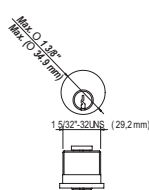

Additional Prices - Gross prices

Ref	Remarks	€
G	Gain durability	21,30

Model Ax660

SALTO XS4 Electronic Escutcheon Ax660,
For ANSI mortise locks, 2 handles, any type, built in mechanical cylinder with
audit housing, (mechanical cylinder not included, for technical specifications consult SALTO).

Prices - Gross prices

€



Picopass: Standard - standard square spindles, finishes and handles.	525,95
Picopass: Wireless convertible - standard square spindles, finishes and handles.	564,75
Picopass: Wireless - standard square spindles, finishes and handles.	662,55
Picopass: Amok - standard square spindles, finishes and handles.	695,85



Legic: Standard - standard square spindles, finishes and handles.	501,25
Legic: Wireless convertible - standard square spindles, finishes and handles.	540,15
Legic: Wireless - standard square spindles, finishes and handles.	637,95
Legic: Amok - standard square spindles, finishes and handles.	626,50



Mifare DESFire: Standard - standard square spindles, finishes and handles.	501,25
Mifare DESFire: Wireless convertible - standard square spindles, finishes and handles.	540,15
Mifare DESFire: Wireless - standard square spindles, finishes and handles.	637,95
Mifare DESFire: Amok - standard square spindles, finishes and handles.	626,50



BLE Mifare DESFire: additional price to add to the Mifare DESFire price. Gross price	27,70
--	--------------



HID iCLASS: Standard - standard square spindles, finishes and handles.	622,60
HID iCLASS: Wireless convertible - standard square spindles, finishes and handles.	661,50
HID iCLASS: Wireless - standard square spindles, finishes and handles.	759,35
HID iCLASS: Amok - standard square spindles, finishes and handles.	903,80



BLE HID iCLASS: additional price to add to the HID iCLASS price. Gross price	27,70
--	--------------

Model Ax666

SALTO XS4 Electronic Escutcheon Ax666,
For ANSI mortise locks, 2 handles, any type, electronic “do not disturb” system, built in mechanical cylinder with audit housing, (mechanical cylinder not included).

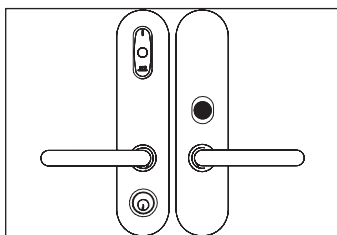

Inside Picopass
LEGIC advant - Prime
Mifare - DESFire
BLE Mifare DESFire
HID iCLASS
BLE HID iCLASS

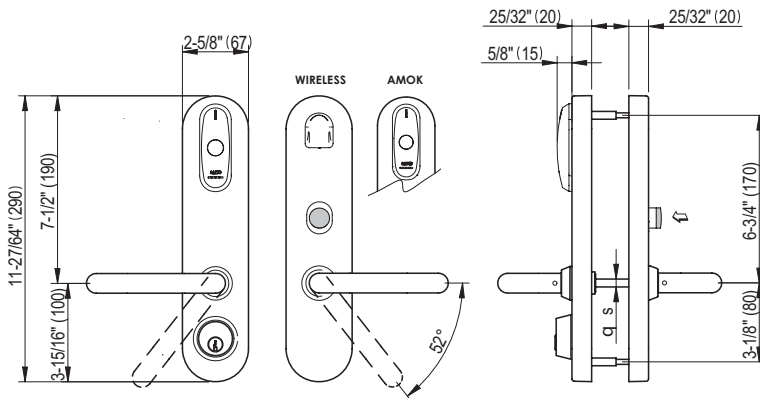

Technology	Escutcheon width	Function	Handle	Handle to thumbturn	Finish	Door thickness	Square spindle	Handing	Wireless option	Gain durability	
A7 PICOPASS	6	66	U	00 without distance	IM	2 Fo = 15-17,5mm	8 8mm	-	-		
			A					-			
			L					-			
A8 LEGIC			W		IP ²	3 32-47 mm	-				
			H ²				-				
			Y ²				-				
A9 MIFARE			S ^{1,2}		PP	4 45-60mm	D ⁴ 7mm diamond	R/L ¹			C Convertible
			B ²					-			
			P ²					-			
AB MIFARE BLE			O ¹		PM	B Fo = 20-22,5mm	S 8mm split	R/L ¹			W Wireless
			J					-			
			T					-			
AH HID iCLASS	Z	IA	6 60-75mm	U 7mm diamond split	-	G Gain durability					
	G				-						
	N				-						
AJ BLE HID iCLASS	K ¹	NE ²	7 75-90mm	6 7,6mm split	R/L ¹	A ³ Amok					
	2 ²				-						
	3 ²				-						
	4 ²	BC ² BioCote	9 90-105mm Fo = 16.5 -59mm		-						
	5 ²				1 105-120mm Fo = 30.5 - 89mm	-					
	7 ²				-						



¹ For handed lever handles, only for S, O or K handles.

² This option has an additional price please refer to the handles or finishes chapter.

³ Not available in BLE Mifare DESFire.

⁴ Only for A handle.

Cylinders for the override

Model 6
Mortise cylinder

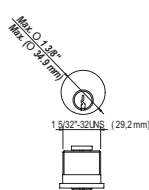

Additional Prices - Gross prices

Ref	Remarks	€
G	Gain durability	21,30

Model Ax666

SALTO XS4 Electronic Escutcheon Ax666,
For ANSI mortise locks, 2 handles, any type, electronic “do not disturb” system, built in mechanical cylinder with audit housing, (mechanical cylinder not included).

Prices - Gross prices

€



Picopass: Standard - standard square spindles, finishes and handles.

554,35

Picopass: Wireless convertible - standard square spindles, finishes and handles.

593,15

Picopass: Wireless - standard square spindles, finishes and handles.

690,85

Picopass: Amok - standard square spindles, finishes and handles.

724,30



Legic: Standard - standard square spindles, finishes and handles.

528,20

Legic: Wireless convertible - standard square spindles, finishes and handles.

567,15

Legic: Wireless - standard square spindles, finishes and handles.

664,80

Legic: Amok - standard square spindles, finishes and handles.

653,25



Mifare DESFire: Standard - standard square spindles, finishes and handles.

528,20

Mifare DESFire: Wireless convertible - standard square spindles, finishes and handles.

567,15

Mifare DESFire: Wireless - standard square spindles, finishes and handles.

664,80

Mifare DESFire: Amok - standard square spindles, finishes and handles.

653,25



BLE Mifare DESFire: additional price to add to the Mifare DESFire price. **Gross price**

27,70



HID iCLASS: Standard - standard square spindles, finishes and handles.

656,60

HID iCLASS: Wireless convertible - standard square spindles, finishes and handles.

695,35

HID iCLASS: Wireless - standard square spindles, finishes and handles.

793,25

HID iCLASS: Amok - standard square spindles, finishes and handles.

937,80



BLE HID iCLASS: additional price to add to the HID iCLASS price. **Gross price**

27,70

Model Ax668

SALTO XS4 Electronic Escutcheon Ax668, For ANSI mortise locks, 2 handles, any type, inside thumbturn 90°, with connector for mortise lock, built in mechanical cylinder with audit housing, (mechanical cylinder not included).

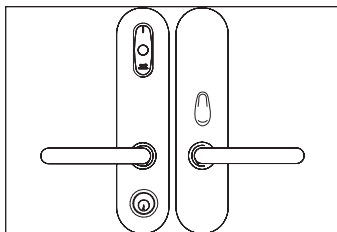

Inside Picopass
LEGIC advant - Prime
Mifare - DESFire
BLE Mifare DESFire
HID iCLASS
BLE HID iCLASS

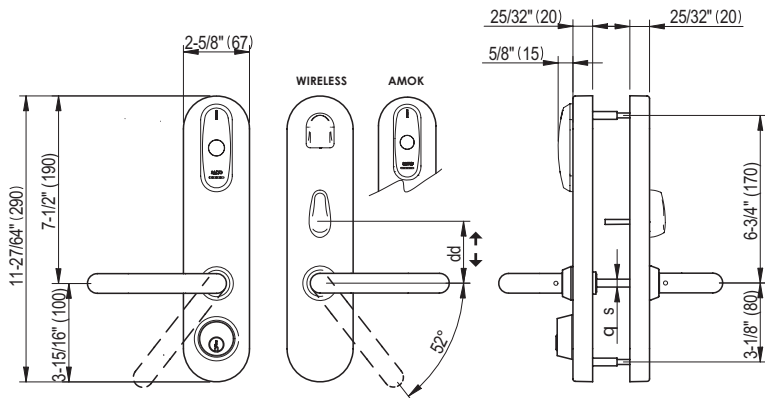

Technology	Escutcheon width	Function	Handle	Handle to thumbturn	Finish	Door thickness	Square spindle	Handing	Wireless option	Gain durability			
A7 PICOPASS	6	68	U	61 61mm	IM	3 32-47 mm	8 8mm	-	-	-			
			A										
			L										
A8 LEGIC			W										
			H ²			IP ²		4 45-60mm			-		
			Y ²										
S ^{1,2}													
A9 MIFARE			B ²	62 62mm	PP	6 60-75mm	D ⁴ 7mm diamond	R/L ¹					
			P ²					-					
			O ¹					R/L ¹					
AB MIFARE BLE			J			Compatible with SALTO LA1T locks		PM			7 75-90mm	S 8mm split	-
			T										-
	Z	-											
AH HID iCLASS	G	63 63mm	IA	9 90-105mm	U 7mm diamond split		R/L ¹						
	N						-						
	K ¹						-						
AJ BLE HID iCLASS	2 ²		NE ²	1 105-120mm		BC ² BioCote	-	-					
	3 ²							-					
	4 ²							-					
	5 ²	-											
	7 ²												



¹ For handed lever handles, only for S, O or K handles.

² This option has an additional price please refer to the handles or finishes chapter.

³ Not available in BLE Mifare DESFire.

⁴ Only for A handle.

Cylinders for the override

Model 6
Mortise cylinder

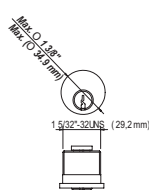

Additional Prices - Gross prices

Ref	Remarks	€
G	Gain durability	21,30

Model Ax668

SALTO XS4 Electronic Escutcheon Ax668, For ANSI mortise locks, 2 handles, any type, inside thumbturn 90°, with connector for mortise lock, built in mechanical cylinder with audit housing, (mechanical cylinder not included).

Prices - Gross prices

€



Picopass: Standard - standard square spindles, finishes and handles.	569,40
Picopass: Wireless convertible - standard square spindles, finishes and handles.	608,25
Picopass: Wireless - standard square spindles, finishes and handles.	706,05
Picopass: Amok - standard square spindles, finishes and handles.	739,40



Legic: Standard - standard square spindles, finishes and handles.	542,70
Legic: Wireless convertible - standard square spindles, finishes and handles.	581,55
Legic: Wireless - standard square spindles, finishes and handles.	679,30
Legic: Amok - standard square spindles, finishes and handles.	667,85



Mifare DESFire: Standard - standard square spindles, finishes and handles.	542,70
Mifare DESFire: Wireless convertible - standard square spindles, finishes and handles.	581,55
Mifare DESFire: Wireless - standard square spindles, finishes and handles.	679,30
Mifare DESFire: Amok - standard square spindles, finishes and handles.	667,85



BLE Mifare DESFire: additional price to add to the Mifare DESFire price. Gross price	27,70
--	--------------



HID iCLASS: Standard - standard square spindles, finishes and handles.	656,60
HID iCLASS: Wireless convertible - standard square spindles, finishes and handles.	695,35
HID iCLASS: Wireless - standard square spindles, finishes and handles.	793,25
HID iCLASS: Amok - standard square spindles, finishes and handles.	937,80



BLE HID iCLASS: additional price to add to the HID iCLASS price. Gross price	27,70
--	--------------

ANSI wide body escutcheon with keypad

Model Ax650xK

SALTO XS4 Electronic Escutcheon Ax650, with keypad
For ANSI mortise locks, 2 handles, any type.

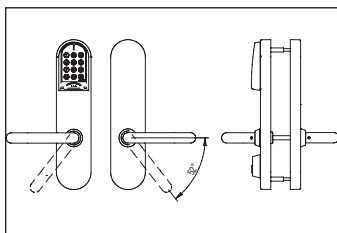

BLE MIFARE - DESFire
BLE HID iCLASS

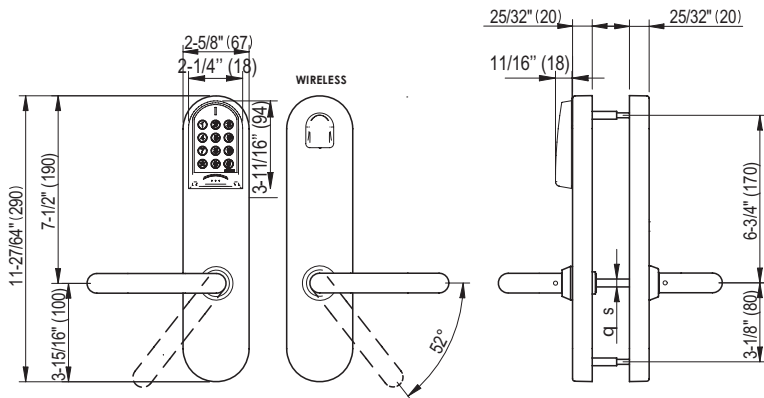

Technology	Escutcheon width	Function	Handle	Handle to thumbturn	Finish	Door thickness	Square spindle	Handing	Wireless option	Keypad option	Gain durability						
AB BLE MIFARE DESFire	6	50	U	00 without distance	IM	2 Fo = 15-17,5mm	8 8mm	-	-	K	-						
			A			3 32-47 mm		-									
			L					-									
			W		IP ²	A Fo = 17.5 -20mm	D ³ 7mm diamond	-									
			H ²			-											
			Y ²			-											
			AJ BLE HID iCLASS		6	50	S ^{1,2}	00 without distance				PP	4 45-60mm	S 8mm split	R/L ¹	C Convertible	G Gain durability
							B ²						-				
							P ²					PM	B Fo = 20-22,5mm	U 7mm diamond split	R/L ¹		
							O ¹						-				
J	-																
T	IA	5 Fo = 22.5-25mm		6 60-75mm			-										
G		-															
N		-															
AJ BLE HID iCLASS	6	50		K ¹			00 without distance		NE ²	7 75-90mm	6 7,6mm split	R/L ¹	W Wireless	G Gain durability			
				2 ²						-							
			3 ²	9 90-105mm Fo = 16.5 -59mm	1 105-120mm Fo = 30.5 - 89mm	-											
			4 ²			-											
			5 ²	-	-	-											
7 ²	-	-	-														

Additional Prices - Gross prices



¹ For handed lever handles, only for S, O or K handles.



² This option has an additional price please refer to the handles or finishes chapter.

³ Only for A handle.

Ref	Remarks	€
G	Gain durability	21,30

ANSI wide body escutcheon with keypad

Model Ax650xK	SALTO XS4 Electronic Escutcheon Ax650, with keypad For ANSI mortise locks, 2 handles, any type.
----------------------	--

Prices - Gross prices		€
 MIFARE DESFire	BLE MIFARE DESFire: Standard - standard square spindles, finishes and handles.	620,40
	BLE MIFARE DESFire: Wireless convertible - standard square spindles, finishes and handles.	666,95
	BLE MIFARE DESFire: Wireless - standard square spindles, finishes and handles.	784,40
<hr/>		
 	BLE HID iCLASS: Standard - standard square spindles, finishes and handles.	765,50
	BLE HID iCLASS: Wireless convertible - standard square spindles, finishes and handles.	812,15
	BLE HID iCLASS: Wireless - standard square spindles, finishes and handles.	929,50

Model Ax656xK

SALTO XS4 Electronic Escutcheon Ax656 with keypad,
For ANSI mortise locks, 2 Handles, any type, Electronic “do not disturb” system.

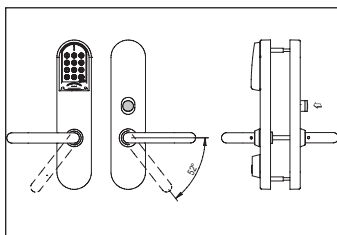

BLE MIFARE - DESFire
BLE HID iCLASS

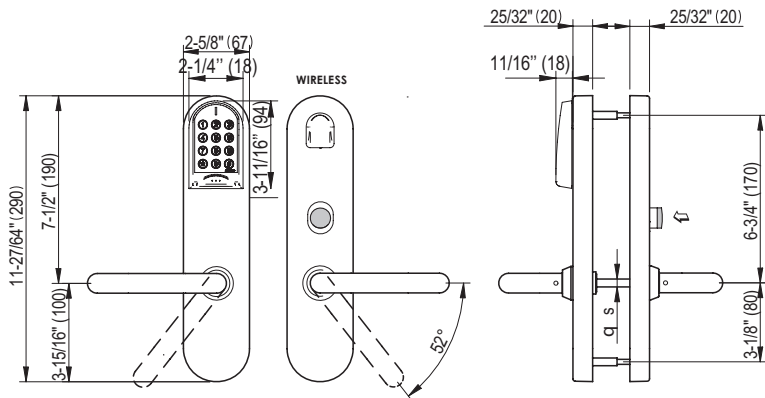

Technology	Escutcheon width	Function	Handle	Handle to thumbturn	Finish	Door thickness	Square spindle	Handing	Wireless option	Keypad option	Gain durability							
AB BLE MIFARE DESFire	6	56	U	00 without distance	IM	2 Fo = 15-17,5mm	8 8mm	-	-	K	-							
			A			3 32-47 mm		-										
			L					-										
			W		IP ²	A Fo = 17.5 -20mm	D ³ 7mm diamond	-										
			H ²			-												
			Y ²			-												
			AJ BLE HID iCLASS		6	56	S ^{1,2}	00 without distance				PP	4 45-60mm	S 8mm split	R/L ¹	C Convertible	K	G Gain durability
							B ²						-					
							P ²					PM	B Fo = 20-22,5mm	U 7mm diamond split	R/L ¹			
							O ¹						-					
J	-																	
T	IA	5 Fo = 22.5-25mm		6 60-75mm			-											
G		-																
N		-																
AJ BLE HID iCLASS	6	56		K ¹			00 without distance		NE ²	7 75-90mm	6 7,6mm split	R/L ¹	W Wireless	K	G Gain durability			
				2 ²						-								
			3 ²	9 90-105mm Fo = 16.5 -59mm	1 105-120mm Fo = 30.5 - 89mm	-												
			4 ²	-														
			5 ²	-														
7 ²	BC ² BioCote	1 105-120mm Fo = 30.5 - 89mm	6 7,6mm split	-														

Additional Prices - Gross prices



Ref	Remarks	€
G	Gain durability	21,30

¹ For handed lever handles, only for S, O or K handles.

² This option has an additional price please refer to the handles or finishes chapter.

³ Only for A handle.

<p style="font-size: 1.2em; font-weight: bold;">Model Ax656xK</p>	<p>SALTO XS4 Electronic Escutcheon Ax656 with keypad, For ANSI mortise locks, 2 Handles, any type, Electronic “do not disturb” system.</p>
---	---

Prices - Gross prices		€	
	MIFARE DESFire	BLE MIFARE DESFire: Standard - standard square spindles, finishes and handles.	652,80
	BLE MIFARE DESFire: Wireless convertible - standard square spindles, finishes and handles.	699,45	
	BLE MIFARE DESFire: Wireless - standard square spindles, finishes and handles.	816,75	
		BLE HID iCLASS: Standard - standard square spindles, finishes and handles.	806,25
		BLE HID iCLASS: Wireless convertible - standard square spindles, finishes and handles.	852,70
		BLE HID iCLASS: Wireless - standard square spindles, finishes and handles.	970,20

Model Ax658xK

SALTO XS4 Electronic Escutcheon Ax658 with keypad,
For ANSI mortise locks, 2 handles, any type, inside thumbturn 90°, with
connector for mortise lock with micro-switch.

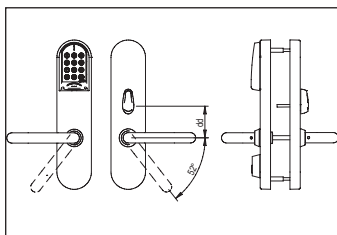

BLE MIFARE - DESFire
BLE HID iCLASS

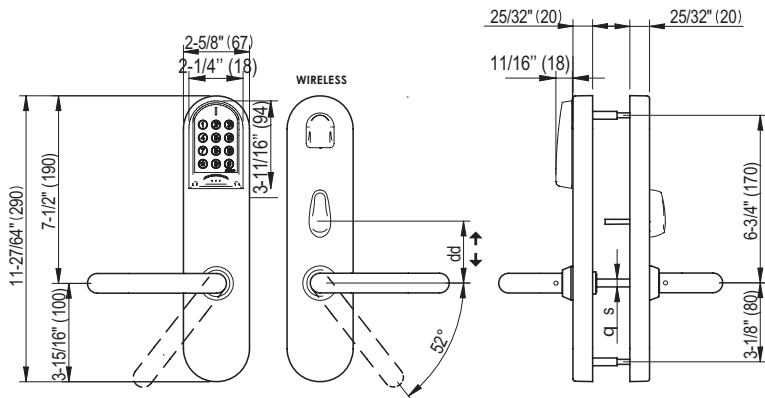

Technology	Escutcheon width	Function	Handle	Handle to thumbturn	Finish	Door thickness	Square spindle	Handing	Wireless option	Keypad option	Gain durability						
AB BLE MIFARE DESFire	6	58	U	61 61mm	IM	3 32-47 mm	8 8mm	-	-	K	-						
			A														
			L														
			W														
			H ²														
			AJ BLE HID iCLASS	6	58	Y ²	62 62mm	IP ²				4 45-60mm	D ⁴ 7mm diamond	-	C Convertible	K	-
						S ^{1,2}											
						B ²											
						P ²											
						O ¹											
AJ BLE HID iCLASS	6	58				J	63 63mm	PM	7 75-90mm	S 8mm split	-	W Wireless	K	G Gain durability			
						T											
						G											
						N											
						Z											
			AJ BLE HID iCLASS	6	58	K ¹	63 63mm	IA	9 90-105mm	U 7mm diamond split	R/L ¹				W Wireless	K	G Gain durability
						2 ²											
						3 ²											
						4 ²											
						5 ²											
AJ BLE HID iCLASS	6	58				7 ²	63 63mm	NE ²	1 105-120mm	U 7mm diamond split	-	W Wireless	K	G Gain durability			
						BC ² BioCote											
						1											
						2											
						3											

Additional Prices - Gross prices





¹ For handed lever handles, only for S, O or K handles.

² This option has an additional price please refer to the handles or finishes chapter.

³ Only for A handle.

Ref	Remarks	€
G	Gain durability	21,30

Model Ax658xK	SALTO XS4 Electronic Escutcheon Ax658 with keypad, For ANSI mortise locks, 2 handles, any type, inside thumbturn 90°, with connector for mortise lock with micro-switch.
----------------------	---

Prices - Gross prices		€
 MIFARE DESFire	BLE MIFARE DESFire: Standard - standard square spindles, finishes and handles.	652,80
	BLE MIFARE DESFire: Wireless convertible - standard square spindles, finishes and handles.	699,45
	BLE MIFARE DESFire: Wireless - standard square spindles, finishes and handles.	816,75
 	BLE HID iCLASS: Standard - standard square spindles, finishes and handles.	806,25
	BLE HID iCLASS: Wireless convertible - standard square spindles, finishes and handles.	852,70
	BLE HID iCLASS: Wireless - standard square spindles, finishes and handles.	970,20

ANSI wide body escutcheon with keypad

Model Ax660xK

SALTO XS4 Electronic Escutcheon Ax660, For ANSI mortise locks, 2 handles, any type, built in mechanical cylinder with audit housing, (mechanical cylinder not included, for technical specifications consult SALTO).

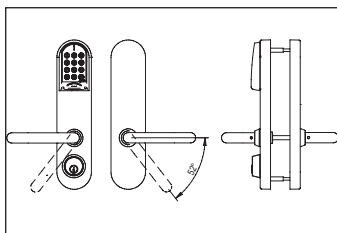

BLE MIFARE - DESFire
BLE HID iCLASS

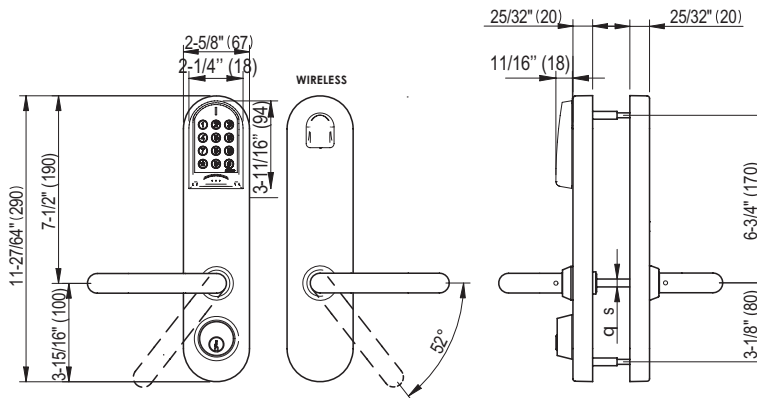

Technology	Escutcheon width	Function	Handle	Handle to thumbturn	Finish	Door thickness	Square spindle	Handing	Wireless option	Keypad option	Gain durability						
AB BLE MIFARE DESFire	6	60	U	00 without distance	IM	2 Fo = 15-17,5mm	8 8mm	-	-	K	-						
			A			3 32-47 mm		-									
			L					-									
			W		IP ²	A Fo = 17.5 -20mm	D ³ 7mm diamond	-									
			H ²			-											
			Y ²			-											
			AJ BLE HID iCLASS		6	60	S ^{1,2}	00 without distance				PP	4 45-60mm	S 8mm split	R/L ¹	C Convertible	G Gain durability
							B ²						-				
							P ²					PM	B Fo = 20-22,5mm	U 7mm diamond split	R/L ¹		
							O ¹						-				
J	-																
T	IA	5 Fo = 22.5-25mm		6 60-75mm			-										
G		-															
N		-															
AJ BLE HID iCLASS	6	60		K ¹			00 without distance		NE ²	7 75-90mm	6 7,6mm split	R/L ¹	W Wireless	G Gain durability			
				2 ²						-							
			3 ²	BC ² BioCote	9 90-105mm Fo = 16.5 -59mm	6 7,6mm split		-									
			4 ²		-												
			5 ²		1 105-120mm Fo = 30.5 - 89mm			-									
7 ²	-	-															



¹ For handed lever handles, only for S, O or K handles.

² This option has an additional price please refer to the handles or finishes chapter.

³ Only for A handle.

Cylinders for the override

Model 6
Mortise cylinder

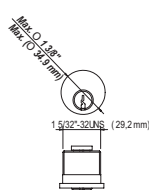



Additional Prices - Gross prices

Ref	Remarks	€
G	Gain durability	21,30

Model Ax660xK

SALTO XS4 Electronic Escutcheon Ax660,
 For ANSI mortise locks, 2 handles, any type, built in mechanical cylinder with
 audit housing, (mechanical cylinder not included, for technical specifications consult SALTO).

Prices - Gross prices		€
 MIFARE DESFire	BLE MIFARE DESFire: Standard - standard square spindles, finishes and handles.	629,15
	BLE MIFARE DESFire: Wireless convertible - standard square spindles, finishes and handles.	675,85
	BLE MIFARE DESFire: Wireless - standard square spindles, finishes and handles.	793,10
<hr/>		
 	BLE HID iCLASS: Standard - standard square spindles, finishes and handles.	774,30
	BLE HID iCLASS: Wireless convertible - standard square spindles, finishes and handles.	820,90
	BLE HID iCLASS: Wireless - standard square spindles, finishes and handles.	938,30

Model Ax666xK

SALTO XS4 Electronic Escutcheon Ax666 with keypad,
For ANSI mortise locks, 2 handles, any type, electronic “do not disturb” system, built in mechanical cylinder with audit housing, (mechanical cylinder not included).

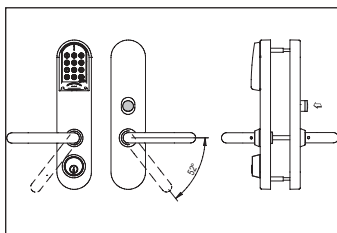

BLE MIFARE - DESFire
BLE HID iCLASS

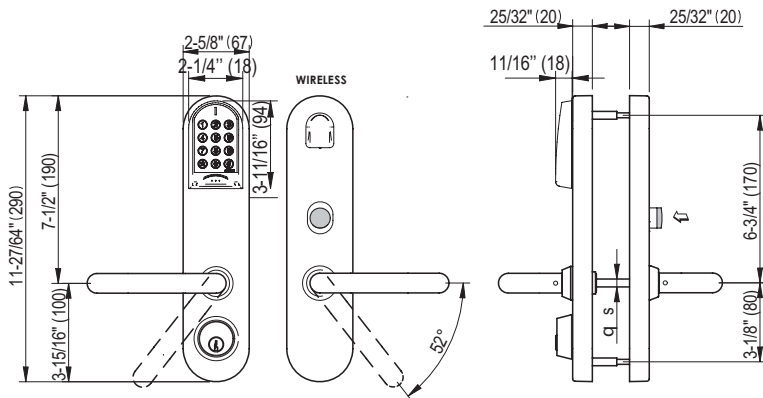

Technology	Escutcheon width	Function	Handle	Handle to thumbturn	Finish	Door thickness	Square spindle	Handing	Wireless option	Keypad option	Gain durability							
AB BLE MIFARE DESFire	6	66	U	00 without distance	IM	2 Fo = 15-17,5mm	8 8mm	-	-	K	-							
			A			3 32-47 mm		-										
			L					-										
			W		IP ²	A Fo = 17.5 -20mm	D ³ 7mm diamond	-										
			H ²			-												
			Y ²			-												
			AJ BLE HID iCLASS		6	66	S ^{1,2}	00 without distance				PP	4 45-60mm	S	R/L ¹	C Convertible	K	G Gain durability
							B ²						-					
							P ²					PM	B Fo = 20-22,5mm	8mm split	R/L ¹			
							O ¹						-					
J	5 Fo = 22.5-25mm	-																
AJ BLE HID iCLASS	6	66		T			00 without distance		IA	6 60-75mm	U 7mm diamond split	-	W Wireless	K	G Gain durability			
				G						-								
				N					NE ²	7 75-90mm	6 7,6mm split	R/L ¹						
				Z						-								
				K ¹						-								
			AJ BLE HID iCLASS	6	66	2 ²		00 without distance	BC ² BioCote	9 90-105mm Fo = 16.5 -59mm	6 7,6mm split	-				W Wireless	K	G Gain durability
						3 ²				-								
						4 ²				-								
5 ²	-																	
7 ²	-	-	-	-	-	-	-	-	-	-								



¹ For handed lever handles, only for S, O or K handles.

² This option has an additional price please refer to the handles or finishes chapter.

³ Only for A handle.

Cylinders for the override

Model 6
Mortise cylinder

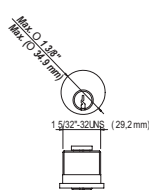



Additional Prices - Gross prices

Ref	Remarks	€
G	Gain durability	21,30

Model Ax666xK

SALTO XS4 Electronic Escutcheon Ax666 with keypad,
 For ANSI mortise locks, 2 handles, any type, electronic “do not disturb” system, built in mechanical cylinder with audit housing, (mechanical cylinder not included).

Prices - Gross prices		€
 MIFARE DESFire	BLE MIFARE DESFire: Standard - standard square spindles, finishes and handles.	661,55
	BLE MIFARE DESFire: Wireless convertible - standard square spindles, finishes and handles.	708,20
	BLE MIFARE DESFire: Wireless - standard square spindles, finishes and handles.	825,50
 	BLE HID iCLASS: Standard - standard square spindles, finishes and handles.	815,00
	BLE HID iCLASS: Wireless convertible - standard square spindles, finishes and handles.	861,55
	BLE HID iCLASS: Wireless - standard square spindles, finishes and handles.	979,10

ANSI wide body escutcheon with keypad

Model Ax668xK

SALTO XS4 Electronic Escutcheon Ax668 with keypad, For ANSI mortise locks, 2 handles, any type, inside thumbturn 90°, with connector for mortise lock. Built in mechanical cylinder with audit (mechanical cylinder not included).

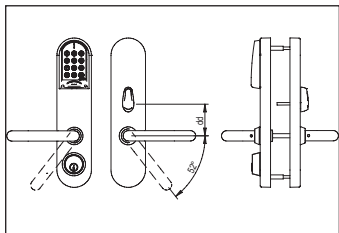

BLE MIFARE - DESFire
BLE HID iCLASS

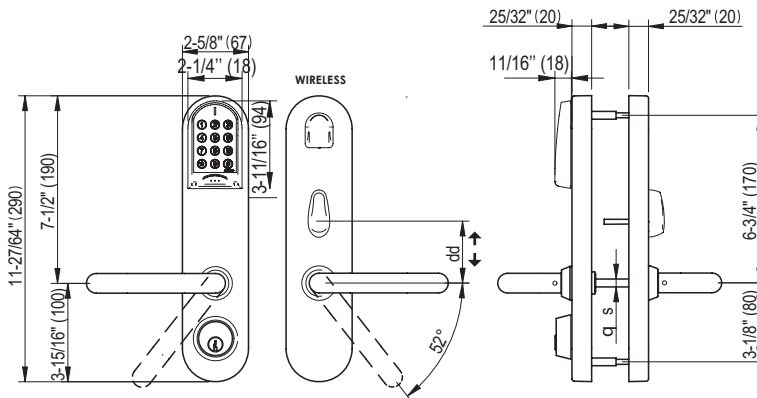

Technology	Escutcheon width	Function	Handle	Handle to thumbturn	Finish	Door thickness	Square spindle	Handing	Wireless option	Keypad option	Gain durability						
AB BLE MIFARE DESFire	6	68	U	61 61mm	IM	3 32-47 mm	8 8mm	-	-	K	-						
			A														
			L														
			W														
			H ²														
			AJ BLE HID iCLASS	6	68	Y ²	62 62mm	IP ²				4 45-60mm	D ⁴ 7mm diamond	-	Convertible	G Gain durability	-
						S ^{1,2}											
						B ²											
						P ²											
						O ¹											
AJ BLE HID iCLASS	6	68				J	63 63mm	PM	7 75-90mm	S 8mm split	R/L ¹	Wireless	G Gain durability	-			
						T											
						G											
						N											
						Z											
			AJ BLE HID iCLASS	6	68	K ¹	63 63mm	IA	9 90-105mm	U 7mm diamond split	-				Wireless	G Gain durability	-
						2 ²											
						3 ²											
						4 ²											
						5 ²											
AJ BLE HID iCLASS	6	68				7 ²	63 63mm	NE ²	1 105-120mm	U 7mm diamond split	-	Wireless	G Gain durability	-			
			AJ BLE HID iCLASS	6	68		63 63mm	BC ² BioCote	1 105-120mm	U 7mm diamond split	-				Wireless	G Gain durability	-



¹ For handed lever handles, only for S, O or K handles.
² This option has an additional price please refer to the handles or finishes chapter.
³ Only for A handle.

Cylinders for the override

Model 6
Mortise cylinder

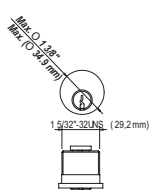



Additional Prices - Gross prices

Ref	Remarks	€
G	Gain durability	21,30

Model Ax668xK

SALTO XS4 Electronic Escutcheon Ax668 with keypad, For ANSI mortise locks, 2 handles, any type, inside thumbturn 90°, with connector for mortise lock. Built in mechanical cylinder with audit (mechanical cylinder not included).

Prices - Gross prices		€
 MIFARE DESFire	BLE MIFARE DESFire: Standard - standard square spindles, finishes and handles.	661,55
	BLE MIFARE DESFire: Wireless convertible - standard square spindles, finishes and handles.	708,20
	BLE MIFARE DESFire: Wireless - standard square spindles, finishes and handles.	825,50
<hr/>		
 	BLE HID iCLASS: Standard - standard square spindles, finishes and handles.	815,00
	BLE HID iCLASS: Wireless convertible - standard square spindles, finishes and handles.	861,55
	BLE HID iCLASS: Wireless - standard square spindles, finishes and handles.	979,10

Model Sx450

SALTO XS4 Electronic Escutcheon Sx450,
2 Handles, any type.

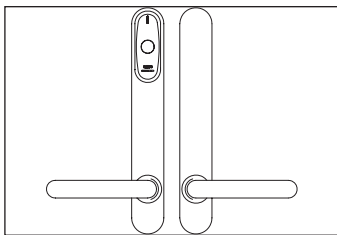

Inside Picopass
LEGIC advant - Prime
Mifare - DESFire
BLE Mifare DESFire
HID iCLASS
BLE HID iCLASS

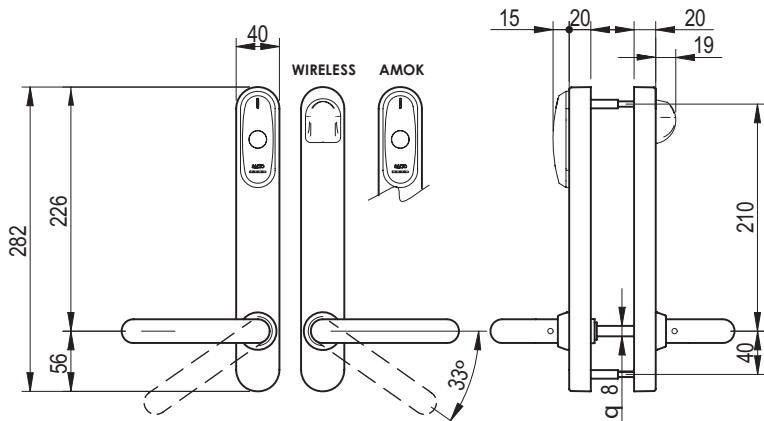

Technology	Escutcheon width	Function	Handle	Handle to thumbturn	Finish	Door thickness	Square spindle	Handing	Wireless option	Gain durability																		
S7 PICOPASS	4	50	U	00 No cylinder	IM	3 32-47 mm	8 8mm	-	-	-																		
			L					-																				
			W					-																				
S8 LEGIC			4		50	H ²		00 No cylinder			IP ²	4 45-60mm	8 8mm	-	-	-												
						I ²								-														
						Y ²								-														
S9 MIFARE						4					50	S ^{1,2}		00 No cylinder			PP	6 60-75mm	8 8mm	R/L ¹	-	-						
												B ²								-								
												P ²								-								
SB MIFARE BLE												4					50	O ¹		00 No cylinder			PM	6 60-75mm	8 8mm split	R/L ¹	-	C Convertible
																		J								-		
																		T								-		
SH HID iCLASS	4	50		G			00 No cylinder		IA	7 75-90mm								8 8mm split					-	-		W Wireless		
				N																			-					
				K ¹																			-					
SJ BLE HID iCLASS			4	50	2 ²			00 No cylinder	NE ²	9 90-105mm			8 8mm split		R/L ¹	-							G Gain durability					
					3 ²										-													
					4 ²										-													
					4	50			5 ²	00 No cylinder	BC ² BioCote			1 105-120mm	8 8mm split				-		-	A ³ Amok						
									7 ²										-									
																			-									

Additional Prices - Gross prices



¹ For Handed lever handles, only for S, O or K handles.

² This option has an additional price please refer to the handles or finishes chapter.

³ Not available in BLE Mifare DESFire.

Ref	Remarks	€
G	Gain durability	21,30

Model Sx450	SALTO XS4 Electronic Escutcheon Sx450, 2 Handles, any type.
--------------------	--

Prices - Gross prices	€
------------------------------	---



Picopass: Standard - standard square spindles, finishes and handles.	512,85
Picopass: Wireless convertible - standard square spindles, finishes and handles.	551,55
Picopass: Wireless - standard square spindles, finishes and handles.	649,55
Picopass: Amok - standard square spindles, finishes and handles.	682,80



Legic: Standard - standard square spindles, finishes and handles.	488,45
Legic: Wireless convertible - standard square spindles, finishes and handles.	527,20
Legic: Wireless - standard square spindles, finishes and handles.	625,05
Legic: Amok - standard square spindles, finishes and handles.	658,30



Mifare DESFire: Standard - standard square spindles, finishes and handles.	488,45
Mifare DESFire: Wireless convertible - standard square spindles, finishes and handles.	527,20
Mifare DESFire: Wireless - standard square spindles, finishes and handles.	625,05
Mifare DESFire: Amok - standard square spindles, finishes and handles.	658,30



BLE Mifare DESFire: additional price to add to the Mifare DESFire price. Gross price	27,70
--	--------------



HID iCLASS: Standard - standard square spindles, finishes and handles.	606,30
HID iCLASS: Wireless convertible - standard square spindles, finishes and handles.	645,05
HID iCLASS: Wireless - standard square spindles, finishes and handles.	742,90
HID iCLASS: Amok - standard square spindles, finishes and handles.	776,30



BLE HID iCLASS: additional price to add to the HID iCLASS price. Gross price	27,70
--	--------------

Model Sx451

SALTO XS4 Electronic Escutcheon Sx451, 2 Handles, any type, inside thumbturn, with connector for mortise lock with micro-switch.

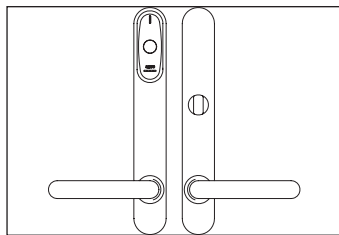

Inside Picopass
LEGIC advant - Prime
Mifare - DESFire
BLE Mifare DESFire
HID iCLASS
BLE HID iCLASS

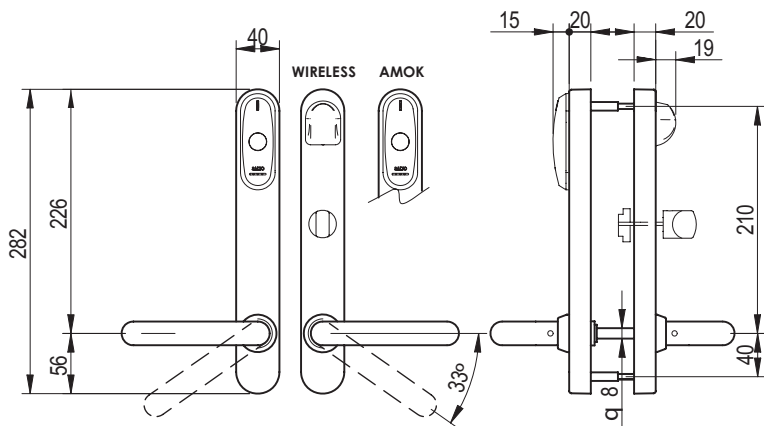

Technology	Escutcheon width	Function	Handle	Handle to thumbturn	Finish	Door thickness	Square spindle	Handing	Wireless option	Gain durability	
S7 PICOPASS	4	51	U	05 no cylinder protection	IM	3 32-47 mm	8 8mm	-	-	-	
			L					-			
			W					-			
S8 LEGIC			H ²		IP ²	4 45-60mm		-			
			I ²					-			
			Y ²					R/L ¹			
S9 MIFARE			S ^{1,2}		PP	6 60-75mm		-			C Convertible
			B ²					-			
			P ²					R/L ¹			
SB MIFARE BLE			J		PM	7 75-90mm		-			W Wireless
			T					-			
	G	-									
SH HID iCLASS	N	IA	9 90-105mm	-	G Gain durability						
	K ¹			R/L ¹							
	2 ²			-							
SJ BLE HID iCLASS	3 ²	NE ²	1 105-120mm	-	A ³ Amok						
	4 ²			-							
	5 ²			-							
	7 ²			-							

Additional Prices - Gross prices



¹ For Handed lever handles, only for S, O or K handles.

² This option has an additional price please refer to the handles or finishes chapter.

³ Not available in BLE Mifare DESFire.

Ref	Remarks	€
G	Gain durability	21,30

Model Sx451	SALTO XS4 Electronic Escutcheon Sx451, 2 Handles, any type, inside thumbturn, with connector for mortise lock with micro-switch.
--------------------	---

Prices - Gross prices	€
------------------------------	---



Picopass: Standard - standard square spindles, finishes and handles.	556,35
Picopass: Wireless convertible - standard square spindles, finishes and handles.	595,20
Picopass: Wireless - standard square spindles, finishes and handles.	692,90
Picopass: Amok - standard square spindles, finishes and handles.	726,30



Legic: Standard - standard square spindles, finishes and handles.	529,75
Legic: Wireless convertible - standard square spindles, finishes and handles.	568,60
Legic: Wireless - standard square spindles, finishes and handles.	666,50
Legic: Amok - standard square spindles, finishes and handles.	699,85



Mifare DESFire: Standard - standard square spindles, finishes and handles.	529,75
Mifare DESFire: Wireless convertible - standard square spindles, finishes and handles.	568,60
Mifare DESFire: Wireless - standard square spindles, finishes and handles.	666,50
Mifare DESFire: Amok - standard square spindles, finishes and handles.	699,85



BLE Mifare DESFire: additional price to add to the Mifare DESFire price. Gross price	27,70
--	--------------



HID iCLASS: Standard - standard square spindles, finishes and handles.	640,00
HID iCLASS: Wireless convertible - standard square spindles, finishes and handles.	678,80
HID iCLASS: Wireless - standard square spindles, finishes and handles.	776,60
HID iCLASS: Amok - standard square spindles, finishes and handles.	809,95



BLE HID iCLASS: additional price to add to the HID iCLASS price. Gross price	27,70
--	--------------

Model Sx454

SALTO XS4 Electronic Escutcheon Sx454,
2 Handles, any type. Outside cylinder cutout.

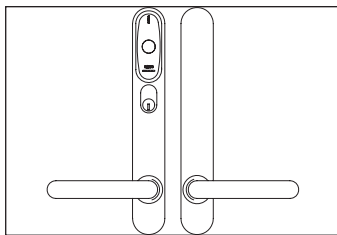

Inside Picopass
LEGIC advant - Prime
Mifare - DESFire
BLE Mifare DESFire
HID iCLASS
BLE HID iCLASS

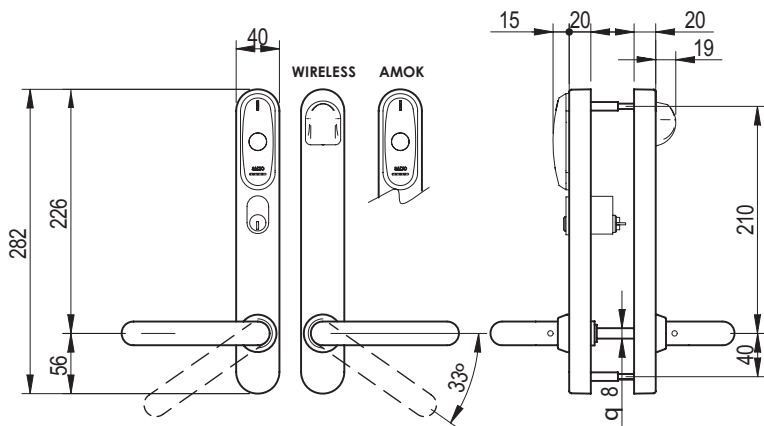

Technology	Escutcheon width	Function	Handle	Handle to thumbturn	Finish	Door thickness	Square spindle	Handing	Wireless option	Gain durability	
S7 PICOPASS	4	54	U	05 no cylinder protection	IM	3 32-47 mm	8 8mm	-	-	-	
			L					-			
			W					-			
S8 LEGIC			H ²		IP ²	4 45-60mm		-			
			I ²					-			
			Y ²					R/L ¹			
S9 MIFARE			S ^{1,2}		PP	6 60-75mm		-			C Convertible
			B ²					-			
			P ²					R/L ¹			
SB MIFARE BLE			J		PM	7 75-90mm		-			W Wireless
			T					-			
	G	-									
SH HID iCLASS	N	IA	9 90-105mm	-	G Gain durability						
	K ¹			R/L ¹							
	2 ²			-							
SJ BLE HID iCLASS	3 ²	NE ²	1 105-120mm	-	A ³ Amok						
	4 ²			-							
	5 ²			-							
	7 ²	BC ² BioCote		-							

Additional Prices - Gross prices



¹ For Handed lever handles, only for S, O or K handles.

² This option has an additional price please refer to the handles or finishes chapter.

³ Not available in BLE Mifare DESFire.

Ref	Remarks	€
G	Gain durability	21,30

Model Sx454	SALTO XS4 Electronic Escutcheon Sx454, 2 Handles, any type. Outside cylinder cutout.
--------------------	---

Prices - Gross prices	€
------------------------------	---



Picopass: Standard - standard square spindles, finishes and handles.	510,85
Picopass: Wireless convertible - standard square spindles, finishes and handles.	549,75
Picopass: Wireless - standard square spindles, finishes and handles.	647,50
Picopass: Amok - standard square spindles, finishes and handles.	680,95



Legic: Standard - standard square spindles, finishes and handles.	486,70
Legic: Wireless convertible - standard square spindles, finishes and handles.	525,45
Legic: Wireless - standard square spindles, finishes and handles.	623,30
Legic: Amok - standard square spindles, finishes and handles.	656,75



Mifare DESFire: Standard - standard square spindles, finishes and handles.	486,70
Mifare DESFire: Wireless convertible - standard square spindles, finishes and handles.	525,45
Mifare DESFire: Wireless - standard square spindles, finishes and handles.	623,30
Mifare DESFire: Amok - standard square spindles, finishes and handles.	656,75



BLE Mifare DESFire: additional price to add to the Mifare DESFire price. Gross price	27,70
--	-------



HID iCLASS: Standard - standard square spindles, finishes and handles.	617,50
HID iCLASS: Wireless convertible - standard square spindles, finishes and handles.	656,45
HID iCLASS: Wireless - standard square spindles, finishes and handles.	754,20
HID iCLASS: Amok - standard square spindles, finishes and handles.	787,55



BLE HID iCLASS: additional price to add to the HID iCLASS price. Gross price	27,70
--	-------

Model Sx455

SALTO XS4 Electronic Escutcheon Sx455, 2 Handles, any type, inside thumbturn, with connector for mortise lock with micro-switch and outside cylinder cutout.

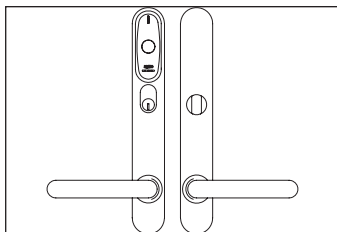

Inside Picopass
 LEGIC advant - Prime
 Mifare - DESFire
 BLE Mifare DESFire
 HID iCLASS
 BLE HID iCLASS

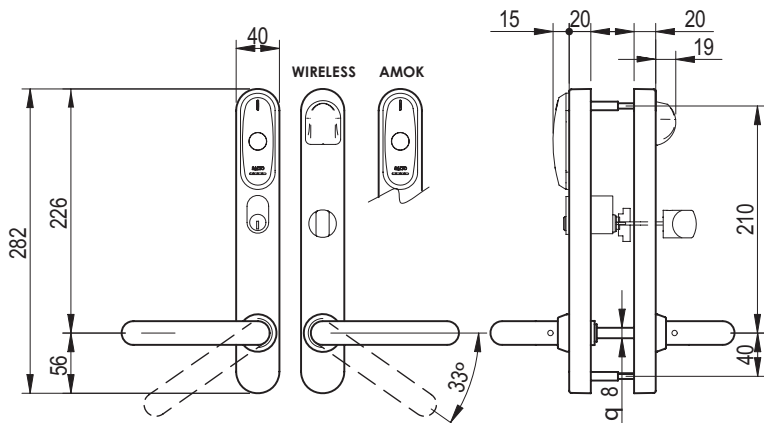

Technology	Escutcheon width	Function	Handle	Handle to thumbturn	Finish	Door thickness	Square spindle	Handing	Wireless option	Gain durability																		
S7 PICOPASS	4	55	U	05 no cylinder protection	IM	3 32-47 mm	8 8mm	-	-	-																		
			L					-																				
			W					-																				
S8 LEGIC			4		55	H ²		05 no cylinder protection			IP ²	4 45-60mm	8 8mm	-	-	-												
						I ²								-														
						Y ²								R/L ¹														
S9 MIFARE						4					55	S ^{1,2}		05 no cylinder protection			PP	6 60-75mm	8 8mm	-	-	C Convertible						
												B ²								-								
												P ²								R/L ¹								
SB MIFARE BLE												4					55	J		05 no cylinder protection			PM	7 75-90mm	S 8mm split	-	-	W Wireless
																		T								-		
																		G								-		
SH HID iCLASS	4	55		N			05 no cylinder protection		IA	9 90-105mm								S 8mm split					-	-		G Gain durability		
				K ¹																			-					
				2 ²																			R/L ¹					
SJ BLE HID iCLASS			4	55	3 ²			05 no cylinder protection	NE ²	1 105-120mm			S 8mm split		-	-							A ³ Amok					
					4 ²										-													
					5 ²										-													
									7 ²																			

Additional Prices - Gross prices



¹ For Handed lever handles, only for S, O or K handles.

² This option has an additional price please refer to the handles or finishes chapter.

³ Not available in BLE Mifare DESFire.

Ref	Remarks	€
G	Gain durability	21,30

Model Sx455

SALTO XS4 Electronic Escutcheon Sx455,
 2 Handles, any type, inside thumbturn, with connector for mortise lock with
 micro-switch and outside cylinder cutout.

Prices - Gross prices

€



Picopass: Standard - standard square spindles, finishes and handles.	560,55
Picopass: Wireless convertible - standard square spindles, finishes and handles.	599,55
Picopass: Wireless - standard square spindles, finishes and handles.	697,30
Picopass: Amok - standard square spindles, finishes and handles.	730,70



Legic: Standard - standard square spindles, finishes and handles.	534,05
Legic: Wireless convertible - standard square spindles, finishes and handles.	572,85
Legic: Wireless - standard square spindles, finishes and handles.	670,55
Legic: Amok - standard square spindles, finishes and handles.	703,95



Mifare DESFire: Standard - standard square spindles, finishes and handles.	534,05
Mifare DESFire: Wireless convertible - standard square spindles, finishes and handles.	572,85
Mifare DESFire: Wireless - standard square spindles, finishes and handles.	670,55
Mifare DESFire: Amok - standard square spindles, finishes and handles.	703,95



BLE Mifare DESFire: additional price to add to the Mifare DESFire price. Gross price	27,70
--	--------------



HID iCLASS: Standard - standard square spindles, finishes and handles.	647,35
HID iCLASS: Wireless convertible - standard square spindles, finishes and handles.	686,20
HID iCLASS: Wireless - standard square spindles, finishes and handles.	783,95
HID iCLASS: Amok - standard square spindles, finishes and handles.	817,30



BLE HID iCLASS: additional price to add to the HID iCLASS price. Gross price	27,70
--	--------------

Scandinavian narrow body escutcheon

Model Sx456

SALTO XS4 Electronic Escutcheon Sx456,
2 Handles, any type and electronic “do not disturb” system.

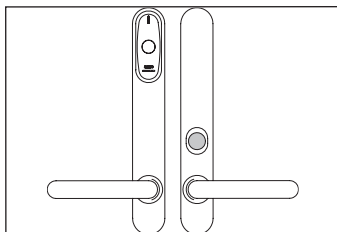

Inside Picopass
LEGIC advant - Prime
Mifare - DESFire
BLE Mifare DESFire
HID iCLASS
BLE HID iCLASS

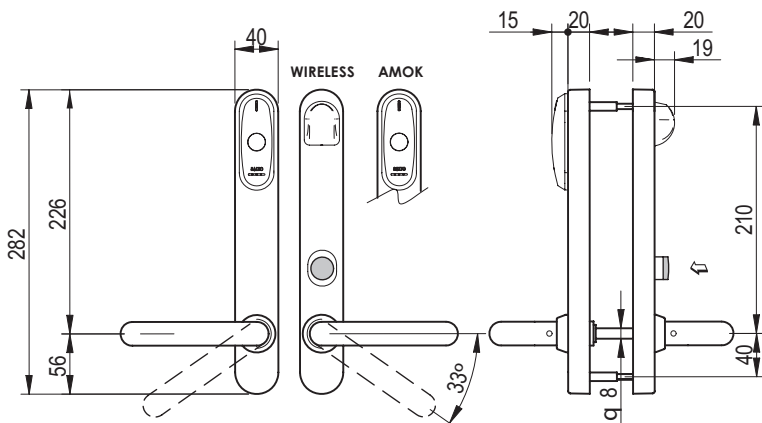

Technology	Escutcheon width	Function	Handle	Handle to thumbturn	Finish	Door thickness	Square spindle	Handing	Wireless option	Gain durability	
S7 PICOPASS	4	56	U	00 No cylinder	IM	3 32-47 mm	8 8mm	-	-	-	
			L					-			
			W					-			
S8 LEGIC			H ²		IP ²	4 45-60mm		-			
			I ²					-			
			Y ²					R/L ¹			
S9 MIFARE			S ^{1,2}		PP	6 60-75mm		-			C Convertible
			B ²					-			
			P ²					R/L ¹			
SB MIFARE BLE			O ¹		PM	7 75-90mm		-			W Wireless
			J					-			
	T	-									
SH HID iCLASS	G	IA	9 90-105mm	-	G Gain durability						
	N			-							
	K ¹			R/L ¹							
SJ BLE HID iCLASS	2 ²	NE ²	1 105-120mm	-	A ³ Amok						
	3 ²			-							
	4 ²			-							
	5 ²			-							
	7 ²			-							

Additional Prices - Gross prices



¹ For Handed lever handles, only for S, O or K handles.

² This option has an additional price please refer to the handles or finishes chapter.

³ Not available in BLE Mifare DESFire.

Ref	Remarks	€
G	Gain durability	21,30

Model Sx456	SALTO XS4 Electronic Escutcheon Sx456, 2 Handles, any type and electronic “do not disturb” system.
--------------------	---

Prices - Gross prices	€
------------------------------	---



Picopass: Standard - standard square spindles, finishes and handles.	541,10
Picopass: Wireless convertible - standard square spindles, finishes and handles.	579,95
Picopass: Wireless - standard square spindles, finishes and handles.	677,90
Picopass: Amok - standard square spindles, finishes and handles.	711,20



Legic: Standard - standard square spindles, finishes and handles.	515,45
Legic: Wireless convertible - standard square spindles, finishes and handles.	554,20
Legic: Wireless - standard square spindles, finishes and handles.	652,10
Legic: Amok - standard square spindles, finishes and handles.	685,30



Mifare DESFire: Standard - standard square spindles, finishes and handles.	515,45
Mifare DESFire: Wireless convertible - standard square spindles, finishes and handles.	554,20
Mifare DESFire: Wireless - standard square spindles, finishes and handles.	652,10
Mifare DESFire: Amok - standard square spindles, finishes and handles.	685,30



BLE Mifare DESFire: additional price to add to the Mifare DESFire price. Gross price	27,70
---	-------



HID iCLASS: Standard - standard square spindles, finishes and handles.	640,00
HID iCLASS: Wireless convertible - standard square spindles, finishes and handles.	678,80
HID iCLASS: Wireless - standard square spindles, finishes and handles.	776,60
HID iCLASS: Amok - standard square spindles, finishes and handles.	809,95



BLE HID iCLASS: additional price to add to the HID iCLASS price. Gross price	27,70
---	-------

Model Sx457

SALTO XS4 Electronic Escutcheon Sx457,
 2 Handles, any type, electronic “do not disturb” system & outside cylinder
 cutout.

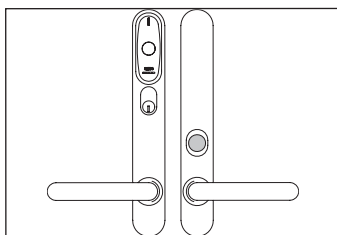

Inside Picopass
 LEGIC advant - Prime
 Mifare - DESFire
 BLE Mifare DESFire
 HID iCLASS
 BLE HID iCLASS

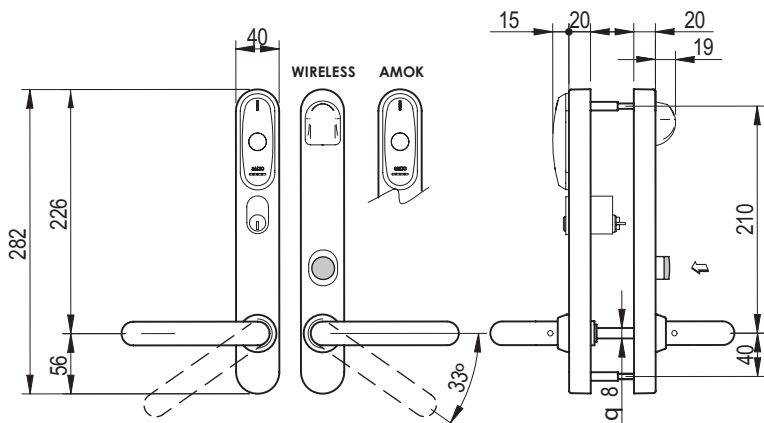

Technology	Escutcheon width	Function	Handle	Handle to thumbturn	Finish	Door thickness	Square spindle	Handing	Wireless option	Gain durability	
S7 PICOPASS	4	57	U	05 no cylinder protection	IM	3 32-47 mm	8 8mm	-	-	-	
			L					-			
			W					-			
S8 LEGIC			H ²		IP ²	4 45-60mm		-			
			I ²					-			
			Y ²					R/L ¹			
S9 MIFARE			S ^{1,2}		PP	6 60-75mm		-			C Convertible
			B ²					-			
			P ²					R/L ¹			
SB MIFARE BLE			O ¹		PM	7 75-90mm		-			W Wireless
			J					-			
			T					-			
SH HID iCLASS	N	IA	9 90-105mm	R/L ¹	G Gain durability						
	K ¹			-							
	2 ²			-							
SJ BLE HID iCLASS	3 ²	NE ²	1 105-120mm	-	A ³ Amok						
	4 ²			-							
	5 ²			-							
	7 ²	BC ² BioCote		-							

Additional Prices - Gross prices



¹ For Handed lever handles, only for S, O or K handles.

² This option has an additional price please refer to the handles or finishes chapter.

³ Not available in BLE Mifare DESFire.

Ref	Remarks	€
G	Gain durability	21,30

Model Sx457

SALTO XS4 Electronic Escutcheon Sx457,
2 Handles, any type, electronic “do not disturb” system & outside cylinder
cutout.

Prices - Gross prices

€



Picopass: Standard - standard square spindles, finishes and handles.

541,10

Picopass: Wireless convertible - standard square spindles, finishes and handles.

579,95

Picopass: Wireless - standard square spindles, finishes and handles.

677,90

Picopass: Amok - standard square spindles, finishes and handles.

711,20



Legic: Standard - standard square spindles, finishes and handles.

515,45

Legic: Wireless convertible - standard square spindles, finishes and handles.

554,20

Legic: Wireless - standard square spindles, finishes and handles.

652,10

Legic: Amok - standard square spindles, finishes and handles.

685,30



Mifare DESFire: Standard - standard square spindles, finishes and handles.

515,45

Mifare DESFire: Wireless convertible - standard square spindles, finishes and handles.

554,20

Mifare DESFire: Wireless - standard square spindles, finishes and handles.

652,10

Mifare DESFire: Amok - standard square spindles, finishes and handles.

685,30



BLE Mifare DESFire: additional price to add to the Mifare DESFire price. **Gross price**

27,70



HID iCLASS: Standard - standard square spindles, finishes and handles.

640,00

HID iCLASS: Wireless convertible - standard square spindles, finishes and handles.

678,80

HID iCLASS: Wireless - standard square spindles, finishes and handles.

776,60

HID iCLASS: Amok - standard square spindles, finishes and handles.

809,95



BLE HID iCLASS: additional price to add to the HID iCLASS price. **Gross price**

27,70

Model Sx650	SALTO XS4 Electronic Escutcheon Sx650, 2 Handles, any type.
--------------------	--

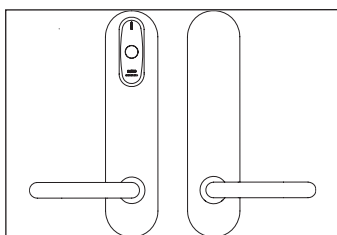

Inside Picopass
LEGIC advant - Prime
Mifare - DESFire
BLE Mifare DESFire
HID iCLASS
BLE HID iCLASS

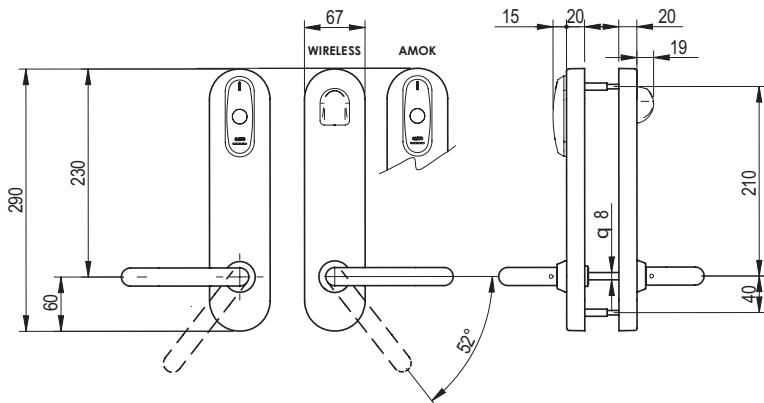

Technology	Escutcheon width	Function	Handle	Handle to thumbturn	Finish	Door thickness	Square spindle	Handing	Wireless option	Gain durability	
S7 PICOPASS	6	50	U	00 No cylinder	IM	3 32-47 mm	8 8mm	-	-	-	
			L					-			
			W					-			
S8 LEGIC			H ²		IP ²	4 45-60mm		-			
			Y ²					-			
			S ^{1,2}					R/L ¹			
S9 MIFARE			B ²		PP	6 60-75mm		-			C Convertible
			P ²					-			
			O ¹					R/L ¹			
SB MIFARE BLE			J		PM	7 75-90mm		-			W Wireless
			T					-			
			G					-			
SH HID iCLASS	N	IA	9 90-105mm	-	G Gain durability						
	K ¹			R/L ¹							
	2 ²			-							
SJ BLE HID iCLASS	3 ²	NE ²	1 105-120mm	-	A ³ Amok						
	4 ²			-							
	5 ²			-							
	7 ²	BC ² BioCote		-							

Additional Prices - Gross prices



¹ For Handed lever handles, only for S, O or K handles.

² This option has an additional price please refer to the handles or finishes chapter.

³ Not available in BLE Mifare DESFire.

Ref	Remarks	€
G	Gain durability	21,30

Model Sx650	SALTO XS4 Electronic Escutcheon Sx650, 2 Handles, any type.
--------------------	--

Prices - Gross prices	€
------------------------------	---



Picopass: Standard - standard square spindles, finishes and handles.	543,45
Picopass: Wireless convertible - standard square spindles, finishes and handles.	582,30
Picopass: Wireless - standard square spindles, finishes and handles.	680,15
Picopass: Amok - standard square spindles, finishes and handles.	713,45



Legic: Standard - standard square spindles, finishes and handles.	517,65
Legic: Wireless convertible - standard square spindles, finishes and handles.	556,40
Legic: Wireless - standard square spindles, finishes and handles.	654,30
Legic: Amok - standard square spindles, finishes and handles.	687,50



Mifare DESFire: Standard - standard square spindles, finishes and handles.	517,65
Mifare DESFire: Wireless convertible - standard square spindles, finishes and handles.	556,40
Mifare DESFire: Wireless - standard square spindles, finishes and handles.	654,30
Mifare DESFire: Amok - standard square spindles, finishes and handles.	687,50



BLE Mifare DESFire: additional price to add to the Mifare DESFire price. Gross price	27,70
--	--------------



HID iCLASS: Standard - standard square spindles, finishes and handles.	635,50
HID iCLASS: Wireless convertible - standard square spindles, finishes and handles.	674,25
HID iCLASS: Wireless - standard square spindles, finishes and handles.	772,05
HID iCLASS: Amok - standard square spindles, finishes and handles.	805,50



BLE HID iCLASS: additional price to add to the HID iCLASS price. Gross price	27,70
--	--------------

Model Sx651

SALTO XS4 Electronic Escutcheon Sx651,
2 Handles, any type, inside thumbturn, with connector for mortise lock with micro-switch.

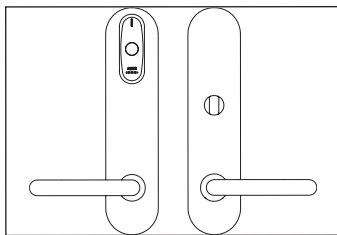

Inside Picopass
LEGIC advant - Prime
Mifare - DESFire
BLE Mifare DESFire
HID iCLASS
BLE HID iCLASS

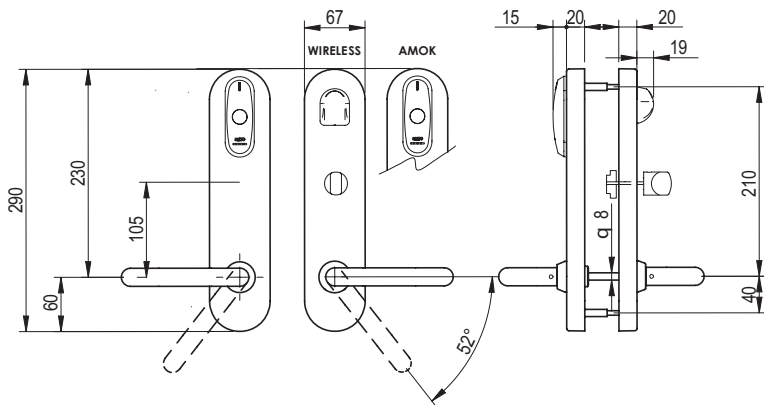

Technology	Escutcheon width	Function	Handle	Handle to thumbturn	Finish	Door thickness	Square spindle	Handing	Wireless option	Gain durability	
S7 PICOPASS	6	51	U	05 no cylinder protection	IM	3 32-47 mm	8 8mm	-	-	-	
			L					-			
			W					-			
S8 LEGIC			H ²		IP ²	4 45-60mm		-			
			Y ²					-			
			S ^{1,2}					R/L ¹			
S9 MIFARE			B ²		PP	6 60-75mm		-			C Convertible
			P ²					-			
			O ¹					R/L ¹			
SB MIFARE BLE			J		PM	7 75-90mm		-			W Wireless
			T					-			
			G					-			
SH HID iCLASS	N	IA	9 90-105mm	-	G Gain durability						
	K ¹			R/L ¹							
	2 ²			-							
SJ BLE HID iCLASS	3 ²	NE ²	1 105-120mm	-	A ³ Amok						
	4 ²			-							
	5 ²			-							
	7 ²	BC ² BioCote		-							

Additional Prices - Gross prices



¹ For Handed lever handles, only for S, O or K handles.

² This option has an additional price please refer to the handles or finishes chapter.

³ Not available in BLE Mifare DESFire.

Ref	Remarks	€
G	Gain durability	21,30

Model Sx651

SALTO XS4 Electronic Escutcheon Sx651,
2 Handles, any type, inside thumbturn, with connector for mortise lock with
micro-switch.

Prices - Gross prices

€



Picopass: Standard - standard square spindles, finishes and handles.

587,05

Picopass: Wireless convertible - standard square spindles, finishes and handles.

625,85

Picopass: Wireless - standard square spindles, finishes and handles.

723,75

Picopass: Amok - standard square spindles, finishes and handles.

757,05



Legic: Standard - standard square spindles, finishes and handles.

559,00

Legic: Wireless convertible - standard square spindles, finishes and handles.

597,80

Legic: Wireless - standard square spindles, finishes and handles.

695,60

Legic: Amok - standard square spindles, finishes and handles.

728,95



Mifare DESFire: Standard - standard square spindles, finishes and handles.

559,00

Mifare DESFire: Wireless convertible - standard square spindles, finishes and handles.

597,80

Mifare DESFire: Wireless - standard square spindles, finishes and handles.

695,60

Mifare DESFire: Amok - standard square spindles, finishes and handles.

728,95



BLE Mifare DESFire: additional price to add to the Mifare DESFire price. **Gross price**

27,70



HID iCLASS: Standard - standard square spindles, finishes and handles.

669,10

HID iCLASS: Wireless convertible - standard square spindles, finishes and handles.

708,00

HID iCLASS: Wireless - standard square spindles, finishes and handles.

805,80

HID iCLASS: Amok - standard square spindles, finishes and handles.

839,10



BLE HID iCLASS: additional price to add to the HID iCLASS price. **Gross price**

27,70

Model Sx654

SALTO XS4 Electronic Escutcheon Sx654,
2 Handles, any type. Outside cylinder cutout.

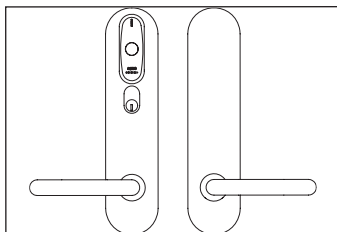

Inside Picopass
LEGIC advant - Prime
Mifare - DESFire
BLE Mifare DESFire
HID iCLASS
BLE HID iCLASS

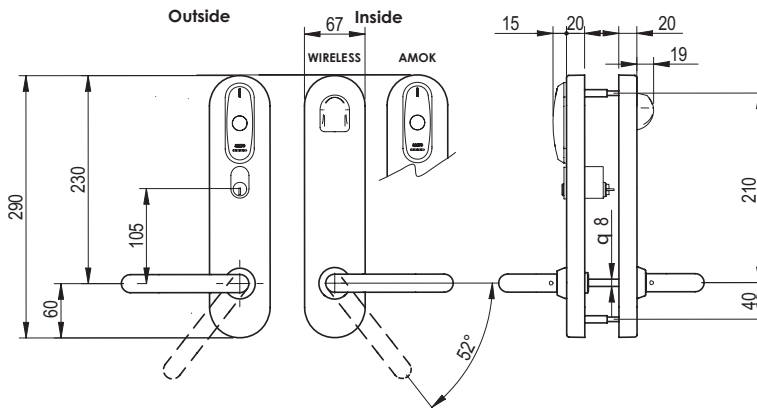

Technology	Escutcheon width	Function	Handle	Handle to thumbturn	Finish	Door thickness	Square spindle	Handing	Wireless option	Gain durability	
S7 PICOPASS	6	54	U	05 no cylinder protection	IM	3 32-47 mm	8 8mm	-	-	-	
			L					-			
			W					-			
S8 LEGIC			H ²		IP ²	4 45-60mm		-			
			Y ²					-			
			S ^{1,2}					R/L ¹			
S9 MIFARE			B ²		PP	6 60-75mm		-			C Convertible
			P ²					-			
			O ¹					R/L ¹			
SB MIFARE BLE			J		PM	7 75-90mm		-			W Wireless
			T					-			
			G					-			
SH HID iCLASS	N	IA	9 90-105mm	-	G Gain durability						
	K ¹			R/L ¹							
	2 ²			-							
SJ BLE HID iCLASS	3 ²	NE ²	1 105-120mm	-	A ³ Amok						
	4 ²			-							
	5 ²			-							
	7 ²	BC ² BioCote		-							

Additional Prices - Gross prices



¹ For Handed lever handles, only for S, O or K handles.

² This option has an additional price please refer to the handles or finishes chapter.

³ Not available in BLE Mifare DESFire.

Ref	Remarks	€
G	Gain durability	21,30

Model Sx654	SALTO XS4 Electronic Escutcheon Sx654, 2 Handles, any type. Outside cylinder cutout.
--------------------	---

Prices - Gross prices	€
------------------------------	---



Picopass: Standard - standard square spindles, finishes and handles.	541,55
Picopass: Wireless convertible - standard square spindles, finishes and handles.	580,35
Picopass: Wireless - standard square spindles, finishes and handles.	678,30
Picopass: Amok - standard square spindles, finishes and handles.	711,60



Legic: Standard - standard square spindles, finishes and handles.	515,85
Legic: Wireless convertible - standard square spindles, finishes and handles.	554,60
Legic: Wireless - standard square spindles, finishes and handles.	652,45
Legic: Amok - standard square spindles, finishes and handles.	685,90



Mifare DESFire: Standard - standard square spindles, finishes and handles.	515,85
Mifare DESFire: Wireless convertible - standard square spindles, finishes and handles.	554,60
Mifare DESFire: Wireless - standard square spindles, finishes and handles.	652,45
Mifare DESFire: Amok - standard square spindles, finishes and handles.	685,90



BLE Mifare DESFire: additional price to add to the Mifare DESFire price. Gross price	27,70
--	--------------



HID iCLASS: Standard - standard square spindles, finishes and handles.	646,70
HID iCLASS: Wireless convertible - standard square spindles, finishes and handles.	685,55
HID iCLASS: Wireless - standard square spindles, finishes and handles.	783,35
HID iCLASS: Amok - standard square spindles, finishes and handles.	816,80



BLE HID iCLASS: additional price to add to the HID iCLASS price. Gross price	27,70
--	--------------

Model Sx655

SALTO XS4 Electronic Escutcheon Sx655, 2 Handles, any type, inside thumbturn, with connector for mortise lock with micro-switch and outside cylinder cutout.

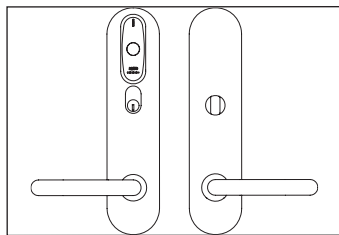

Inside Picopass
LEGIC advant - Prime
Mifare - DESFire
BLE Mifare DESFire
HID iCLASS
BLE HID iCLASS

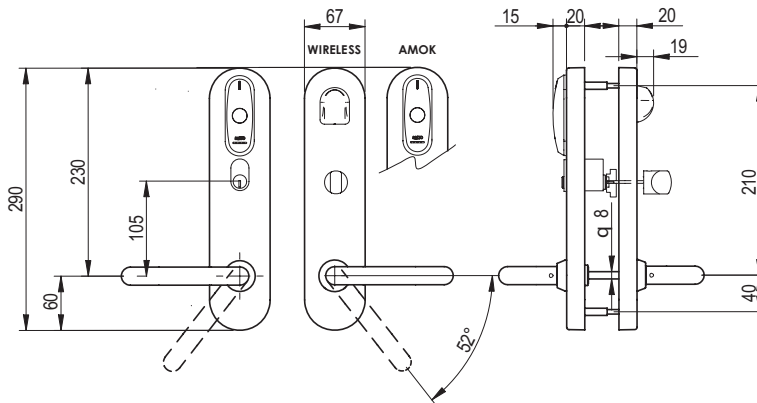

Technology	Escutcheon width	Function	Handle	Handle to thumbturn	Finish	Door thickness	Square spindle	Handing	Wireless option	Gain durability
S7 PICOPASS	6	55	U	05 no cylinder protection	IM	3 32-47 mm	8 8mm	-	-	-
			L					-		
			W					-		
S8 LEGIC			H ²		IP ²	4 45-60mm		-		
			Y ²					-		
			S ^{1,2}					R/L ¹		
S9 MIFARE			B ²		PP	6 60-75mm	-	C Convertible		
			P ²				-			
			O ¹				R/L ¹			
SB MIFARE BLE			J		PM	7 75-90mm	-	W Wireless		
			T				-			
			G				-			
SH HID iCLASS	N	IA	9 90-105mm	-	G Gain durability					
	K ¹			R/L ¹						
	2 ²			-						
SJ BLE HID iCLASS	3 ²	NE ²	1 105-120mm	-		A ³ Amok				
	4 ²			-						
	5 ²			-						
	7 ²			-						
S	8mm split	S	8mm split	-	-					
				-						
				-						
				-						

Additional Prices - Gross prices



¹ For Handed lever handles, only for S, O or K handles.

² This option has an additional price please refer to the handles or finishes chapter.

³ Not available in BLE Mifare DESFire.

Ref	Remarks	€
G	Gain durability	21,30

Model Sx655

SALTO XS4 Electronic Escutcheon Sx655,
2 Handles, any type, inside thumbturn, with connector for mortise lock with
micro-switch and outside cylinder cutout.

Prices - Gross prices

€



Picopass: Standard - standard square spindles, finishes and handles.	591,30
Picopass: Wireless convertible - standard square spindles, finishes and handles.	630,05
Picopass: Wireless - standard square spindles, finishes and handles.	727,90
Picopass: Amok - standard square spindles, finishes and handles.	761,25



Legic: Standard - standard square spindles, finishes and handles.	563,15
Legic: Wireless convertible - standard square spindles, finishes and handles.	602,05
Legic: Wireless - standard square spindles, finishes and handles.	700,00
Legic: Amok - standard square spindles, finishes and handles.	733,25



Mifare DESFire: Standard - standard square spindles, finishes and handles.	563,15
Mifare DESFire: Wireless convertible - standard square spindles, finishes and handles.	602,05
Mifare DESFire: Wireless - standard square spindles, finishes and handles.	700,00
Mifare DESFire: Amok - standard square spindles, finishes and handles.	733,25



BLE Mifare DESFire: additional price to add to the Mifare DESFire price. Gross price	27,70
--	--------------



HID iCLASS: Standard - standard square spindles, finishes and handles.	676,45
HID iCLASS: Wireless convertible - standard square spindles, finishes and handles.	715,30
HID iCLASS: Wireless - standard square spindles, finishes and handles.	813,10
HID iCLASS: Amok - standard square spindles, finishes and handles.	839,10



BLE HID iCLASS: additional price to add to the HID iCLASS price. Gross price	27,70
--	--------------

Model Sx656

SALTO XS4 Electronic Escutcheon Sx656,
2 Handles, any type and electronic “do not disturb” system.

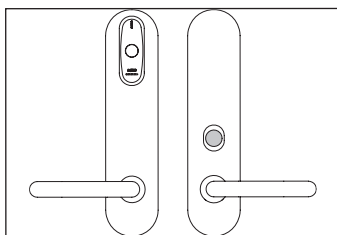

Inside Picopass
LEGIC advant - Prime
Mifare - DESFire
BLE Mifare DESFire
HID iCLASS
BLE HID iCLASS

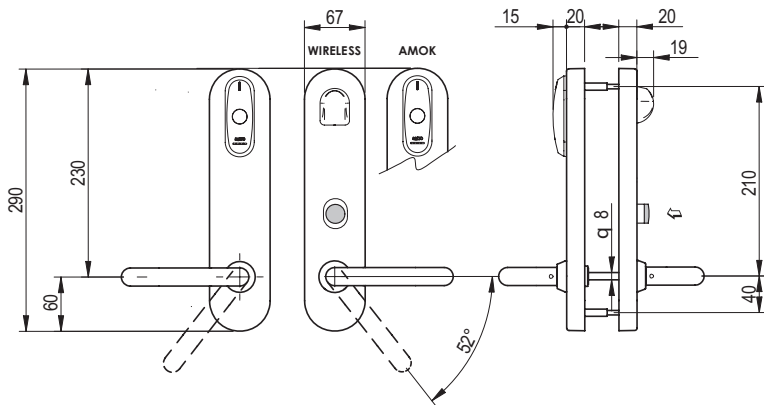

Technology	Escutcheon width	Function	Handle	Handle to thumbturn	Finish	Door thickness	Square spindle	Handing	Wireless option	Gain durability	
S7 PICOPASS	6	50	U	00 No cylinder	IM	3 32-47 mm	8 8mm	-	-	-	
			L					-			
			W					-			
S8 LEGIC			H ²		IP ²	4 45-60mm		-			
			Y ²					-			
			S ^{1,2}					R/L ¹			
S9 MIFARE			B ²		PP	6 60-75mm		-			C Convertible
			P ²					-			
			O ¹					R/L ¹			
SB MIFARE BLE			J		PM	7 75-90mm		-			W Wireless
			T					-			
			G					-			
SH HID iCLASS	N	IA	9 90-105mm	-	G Gain durability						
	K ¹			-							
	2 ²			R/L ¹							
SJ BLE HID iCLASS	3 ²	NE ²	1 105-120mm	-	A ³ Amok						
	4 ²			-							
	5 ²			-							
	7 ²			-							

Additional Prices - Gross prices



¹ For Handed lever handles, only for S, O or K handles.

² This option has an additional price please refer to the handles or finishes chapter.

³ Not available in BLE Mifare DESFire.

Ref	Remarks	€
G	Gain durability	21,30

Model Sx656

SALTO XS4 Electronic Escutcheon Sx656,
2 Handles, any type and electronic “do not disturb” system.

Prices - Gross prices

€



Picopass: Standard - standard square spindles, finishes and handles.

571,75

Picopass: Wireless convertible - standard square spindles, finishes and handles.

610,65

Picopass: Wireless - standard square spindles, finishes and handles.

708,45

Picopass: Amok - standard square spindles, finishes and handles.

741,85



Legic: Standard - standard square spindles, finishes and handles.

544,45

Legic: Wireless convertible - standard square spindles, finishes and handles.

583,30

Legic: Wireless - standard square spindles, finishes and handles.

681,20

Legic: Amok - standard square spindles, finishes and handles.

714,50



Mifare DESFire: Standard - standard square spindles, finishes and handles.

544,45

Mifare DESFire: Wireless convertible - standard square spindles, finishes and handles.

583,30

Mifare DESFire: Wireless - standard square spindles, finishes and handles.

681,20

Mifare DESFire: Amok - standard square spindles, finishes and handles.

714,50



BLE Mifare DESFire: additional price to add to the Mifare DESFire price. **Gross price**

27,70



HID iCLASS: Standard - standard square spindles, finishes and handles.

669,10

HID iCLASS: Wireless convertible - standard square spindles, finishes and handles.

708,00

HID iCLASS: Wireless - standard square spindles, finishes and handles.

805,80

HID iCLASS: Amok - standard square spindles, finishes and handles.

839,10



BLE HID iCLASS: additional price to add to the HID iCLASS price. **Gross price**

27,70

Model Sx657

SALTO XS4 Electronic Escutcheon Sx657,
2 Handles, any type, electronic “do not disturb” system & outside cylinder cutout.

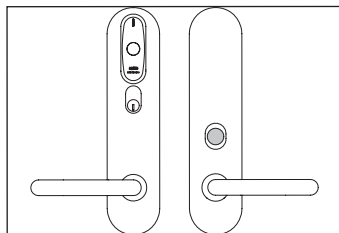

Inside Picopass
LEGIC advant - Prime
Mifare - DESFire
BLE Mifare DESFire
HID iCLASS
BLE HID iCLASS

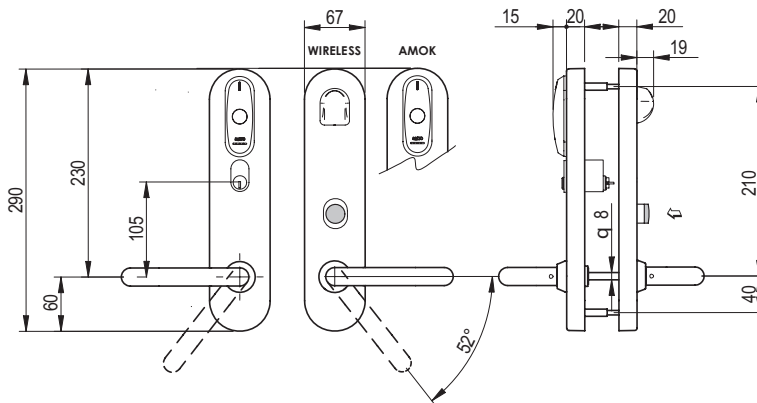

Technology	Escutcheon width	Function	Handle	Handle to thumbturn	Finish	Door thickness	Square spindle	Handing	Wireless option	Gain durability	
S7 PICOPASS	6	57	U	05 no cylinder protection	IM	3 32-47 mm	8 8mm	-	-	-	
			L					-			
			W					-			
S8 LEGIC			H ²		IP ²	4 45-60mm		-			
			Y ²					-			
			S ^{1,2}					R/L ¹			
S9 MIFARE			B ²		PP	6 60-75mm		-			C Convertible
			P ²					-			
			O ¹					R/L ¹			
SB MIFARE BLE			J		PM	7 75-90mm		-			W Wireless
			T					-			
			G					-			
SH HID iCLASS	N	IA	9 90-105mm	-	G Gain durability						
	K ¹			-							
	2 ²			R/L ¹							
SJ BLE HID iCLASS	3 ²	NE ²	1 105-120mm	-	A ³ Amok						
	4 ²			-							
	5 ²			-							
	7 ²	BC ² BioCote		-							

Additional Prices - Gross prices



¹ For Handed lever handles, only for S, O or K handles.

² This option has an additional price please refer to the handles or finishes chapter.

³ Not available in BLE Mifare DESFire.

Ref	Remarks	€
G	Gain durability	21,30

Model Sx657

SALTO XS4 Electronic Escutcheon Sx657,
2 Handles, any type, electronic "do not disturb" system & outside cylinder
cutout.

Prices - Gross prices

€



Picopass: Standard - standard square spindles, finishes and handles.

571,75

Picopass: Wireless convertible - standard square spindles, finishes and handles.

610,65

Picopass: Wireless - standard square spindles, finishes and handles.

708,45

Picopass: Amok - standard square spindles, finishes and handles.

741,85



Legic: Standard - standard square spindles, finishes and handles.

544,45

Legic: Wireless convertible - standard square spindles, finishes and handles.

583,30

Legic: Wireless - standard square spindles, finishes and handles.

681,20

Legic: Amok - standard square spindles, finishes and handles.

714,50



Mifare DESFire: Standard - standard square spindles, finishes and handles.

544,45

Mifare DESFire: Wireless convertible - standard square spindles, finishes and handles.

583,30

Mifare DESFire: Wireless - standard square spindles, finishes and handles.

681,20

Mifare DESFire: Amok - standard square spindles, finishes and handles.

714,50



BLE Mifare DESFire: additional price to add to the Mifare DESFire price. **Gross price**

27,70



HID iCLASS: Standard - standard square spindles, finishes and handles.

669,10

HID iCLASS: Wireless convertible - standard square spindles, finishes and handles.

708,00

HID iCLASS: Wireless - standard square spindles, finishes and handles.

805,80

HID iCLASS: Amok - standard square spindles, finishes and handles.

839,10



BLE HID iCLASS: additional price to add to the HID iCLASS price. **Gross price**

27,70

<h2 style="margin: 0;">Model Sx650xK</h2>	<p>SALTO XS4 Electronic Escutcheon Sx650 with keypad, 2 Handles, any type.</p>
---	--

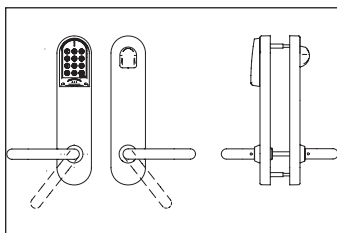

BLE MIFARE - DESFire
BLE HID iCLASS

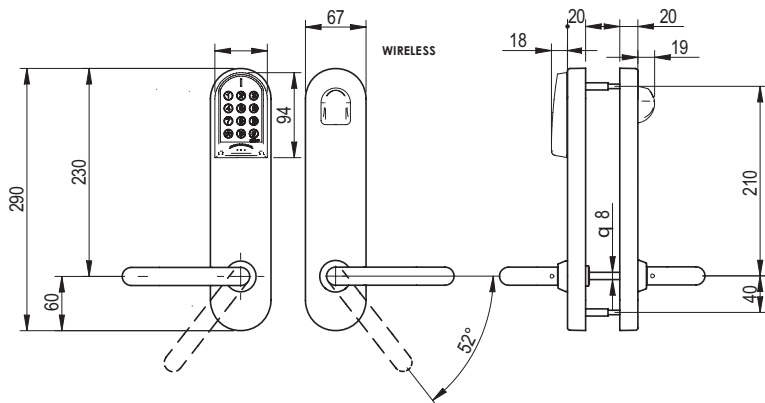

Technology	Escutcheon width	Function	Handle	Handle to thumbturn	Finish	Door thickness	Square spindle	Handing	Wireless option	Keypad option	Gain durability									
SB BLE MIFARE DESFire	6	50	U	00 No cylinder	IM	3 32-47 mm	8 8mm	-	-	K	-									
			L																	
			W																	
			H ²																	
			SJ BLE HID iCLASS		6	50		Y ²				00 No cylinder	IP ²	4 45-60mm	S 8mm split	-	C Convertible	K	G Gain durability	
								S ^{1,2}												
								B ²					PP	6 60-75mm		-				W Wireless
								P ²												
								O ¹					PM	7 75-90mm		R/L ¹				C Convertible
								J												
T	IA	9 90-105mm		-			W Wireless													
G																				
N	NE ²	1 105-120mm		R/L ¹			W Wireless													
K ¹																				
2 ²	BC ² BioCote	1 105-120mm	-	W Wireless																
3 ²																				
4 ²	BC ² BioCote	1 105-120mm	-	W Wireless																
5 ²																				
7 ²	BC ² BioCote	1 105-120mm	-	W Wireless																
7 ²																				

Additional Prices - Gross prices





¹ For Handed lever handles, only for S, O or K handles.

² This option has an additional price please refer to the handles or finishes chapter.

Ref	Remarks	€
G	Gain durability	21,30

Scandinavian wide body escutcheon with keypad

Model Sx650xK	SALTO XS4 Electronic Escutcheon Sx650 with keypad, 2 Handles, any type.
----------------------	---

Prices - Gross prices		€
 MIFARE DESFire	BLE MIFARE DESFire: Standard - standard square spindles, finishes and handles.	648,85
	BLE MIFARE DESFire: Wireless convertible - standard square spindles, finishes and handles.	695,35
	BLE MIFARE DESFire: Wireless - standard square spindles, finishes and handles.	812,75
<hr/>		
 	BLE HID iCLASS: Standard - standard square spindles, finishes and handles.	790,30
	BLE HID iCLASS: Wireless convertible - standard square spindles, finishes and handles.	836,80
	BLE HID iCLASS: Wireless - standard square spindles, finishes and handles.	954,20

Model Sx651xK

SALTO XS4 Electronic Escutcheon Sx651 with keypad,
2 Handles, any type, inside thumbturn, with connector for mortise lock with
micro-switch.

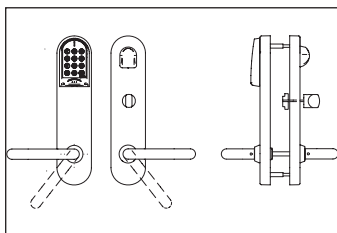

BLE MIFARE - DESFire
BLE HID iCLASS

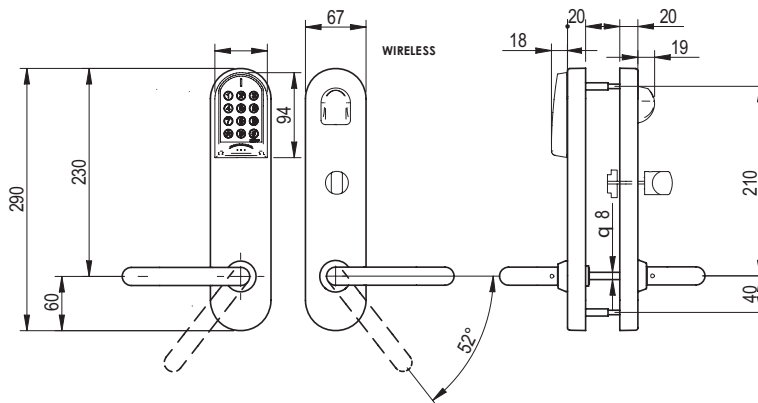

Technology	Escutcheon width	Function	Handle	Handle to thumbturn	Finish	Door thickness	Square spindle	Handing	Wireless option	Keypad option	Gain durability	
SB BLE MIFRARE DESFire	6	51	U	05 no cylinder protection	IM	3 32-47 mm	8 8mm	-	-	K	-	
			L					-				
			W					-				
			H ²					-				
			Y ²		4 45-60mm	IP ²		-				
			S ^{1,2}					R/L ¹				
			B ²		6 60-75mm	PP		-				C
			P ²					-				
			O ¹					R/L ¹				
			SJ BLE HID iCLASS		6	51		J				05 no cylinder protection
T	IA	-										
G		-										
N	9 90-105mm	NE ²		-			W					
K ¹				R/L ¹								
2 ²				-								
3 ²				-								
4 ²	1 105-120mm	BC ² BioCote		-			Wireless					
5 ²			-									
7 ²	-											

Additional Prices - Gross prices





¹ For Handed lever handles, only for S, O or K handles.

² This option has an additional price please refer to the handles or finishes chapter.

Ref	Remarks	€
G	Gain durability	21,30

Model Sx651xK

SALTO XS4 Electronic Escutcheon Sx651 with keypad, 2 Handles, any type, inside thumbturn, with connector for mortise lock with micro-switch.

Prices - Gross prices		€
 MIFARE DESFire	BLE MIFARE DESFire: Standard - standard square spindles, finishes and handles.	698,40
	BLE MIFARE DESFire: Wireless convertible - standard square spindles, finishes and handles.	745,10
	BLE MIFARE DESFire: Wireless - standard square spindles, finishes and handles.	862,40
 	BLE HID iCLASS: Standard - standard square spindles, finishes and handles.	830,75
	BLE HID iCLASS: Wireless convertible - standard square spindles, finishes and handles.	877,40
	BLE HID iCLASS: Wireless - standard square spindles, finishes and handles.	994,55

Model Sx654xK SALTO XS4 Electronic Escutcheon Sx654 with keypad, 2 Handles, any type. Outside cylinder cutout.

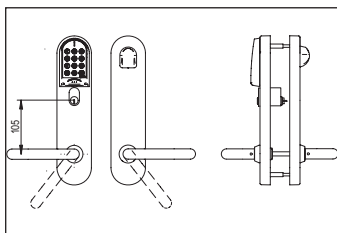

BLE MIFARE - DESFire
BLE HID iCLASS

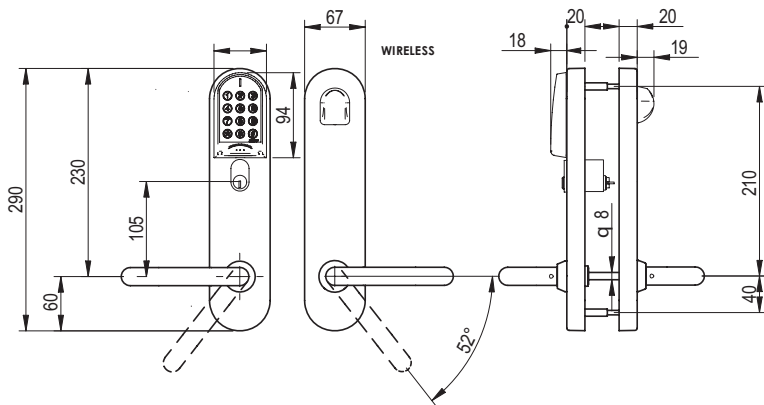

Technology	Escutcheon width	Function	Handle	Handle to thumbturn	Finish	Door thickness	Square spindle	Handing	Wireless option	Keypad option	Gain durability	
SB BLE MIFRARE DESFire	6	54	U	05 no cylinder protection	IM	3 32-47 mm	8 8mm	-	-	K	-	
			L					-				
			W					-				
			H ²					-				
			Y ²		4 45-60mm	IP ²		-				
			S ^{1,2}					R/L ¹				
			B ²		6 60-75mm	PP		-				C Convertible
			P ²					-				
			O ¹					R/L ¹				
			SJ BLE HID iCLASS		6	54		J				05 no cylinder protection
T	-											
G	7 75-90mm	IA		-								
N				-								
K ¹	9 90-105mm	NE ²		-								
2 ²				R/L ¹								
3 ²				-								
4 ²	1 105-120mm	BC ² BioCote		-								
5 ²			-									
7 ²	-											

Additional Prices - Gross prices





¹ For Handed lever handles, only for S, O or K handles.

² This option has an additional price please refer to the handles or finishes chapter.

Ref	Remarks	€
G	Gain durability	21,30

Model Sx654xK	SALTO XS4 Electronic Escutcheon Sx654 with keypad, 2 Handles, any type. Outside cylinder cutout.
----------------------	--

Prices - Gross prices		€
 MIFARE DESFire	BLE MIFARE DESFire: Standard - standard square spindles, finishes and handles.	646,65
	BLE MIFARE DESFire: Wireless convertible - standard square spindles, finishes and handles.	693,20
	BLE MIFARE DESFire: Wireless - standard square spindles, finishes and handles.	810,70
<hr/>		
 	BLE HID iCLASS: Standard - standard square spindles, finishes and handles.	803,90
	BLE HID iCLASS: Wireless convertible - standard square spindles, finishes and handles.	850,40
	BLE HID iCLASS: Wireless - standard square spindles, finishes and handles.	967,80

Model Sx655xK

SALTO XS4 Electronic Escutcheon Sx655 with keypad,
2 Handles, any type, inside thumbturn, with connector for mortise lock with
micro-switch and outside cylinder cutout.

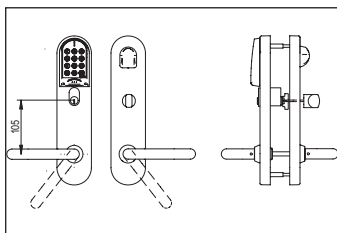

BLE MIFARE - DESFire
BLE HID iCLASS

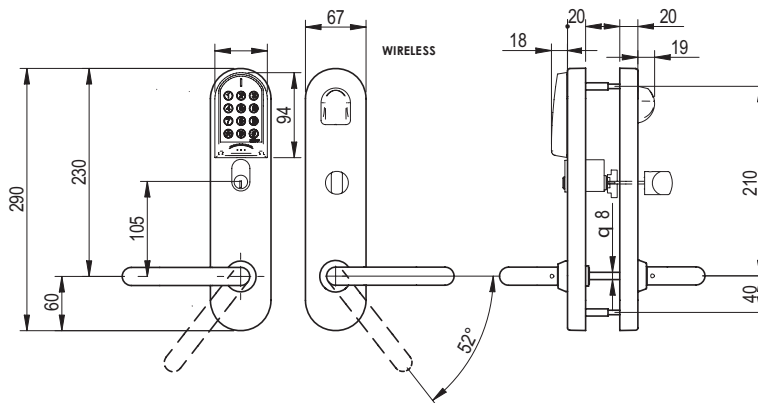

Technology	Escutcheon width	Function	Handle	Handle to thumbturn	Finish	Door thickness	Square spindle	Handing	Wireless option	Keypad option	Gain durability								
SB BLE MIFARE DESFire	6	55	U	05 no cylinder protection	IM	3 32-47 mm	8 8mm	-	-	K	-								
			L					-											
			W					-											
			H ²		IP ²	4 45-60mm		-											
			Y ²					-											
			S ^{1,2}		PP	6 60-75mm		R/L ¹											
			B ²					-											
			P ²					-											
			SJ BLE HID iCLASS		6	55		O ¹				05 no cylinder protection	PM	7 75-90mm	S 8mm split	R/L ¹	C Convertible	K	G Gain durability
								J								-			
T	-																		
G	-																		
N	IA	9 90-105mm		-															
K ¹				R/L ¹															
2 ²				-															
3 ²	NE ²	1 105-120mm		-															
4 ²			-																
5 ²			-																
7 ²	BC ² BioCote	-	-																

Additional Prices - Gross prices





¹ For Handed lever handles, only for S, O or K handles.

² This option has an additional price please refer to the handles or finishes chapter.

Ref	Remarks	€
G	Gain durability	21,30

Scandinavian wide body escutcheon with keypad

Model Sx655xK	SALTO XS4 Electronic Escutcheon Sx655 with keypad, 2 Handles, any type, inside thumbturn, with connector for mortise lock with micro-switch and outside cylinder cutout.
----------------------	--

Prices - Gross prices		€
 MIFARE DESFire	BLE MIFARE DESFire: Standard - standard square spindles, finishes and handles.	703,60
	BLE MIFARE DESFire: Wireless convertible - standard square spindles, finishes and handles.	750,25
	BLE MIFARE DESFire: Wireless - standard square spindles, finishes and handles.	867,60
 	BLE HID iCLASS: Standard - standard square spindles, finishes and handles.	839,50
	BLE HID iCLASS: Wireless convertible - standard square spindles, finishes and handles.	886,05
	BLE HID iCLASS: Wireless - standard square spindles, finishes and handles.	1003,50

Model Sx656xK

SALTO XS4 Electronic Escutcheon Sx656 with keypad,
 2 Handles, any type and electronic "do not disturb" system.

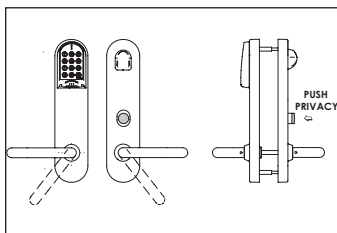

BLE MIFARE - DESFire
 BLE HID iCLASS

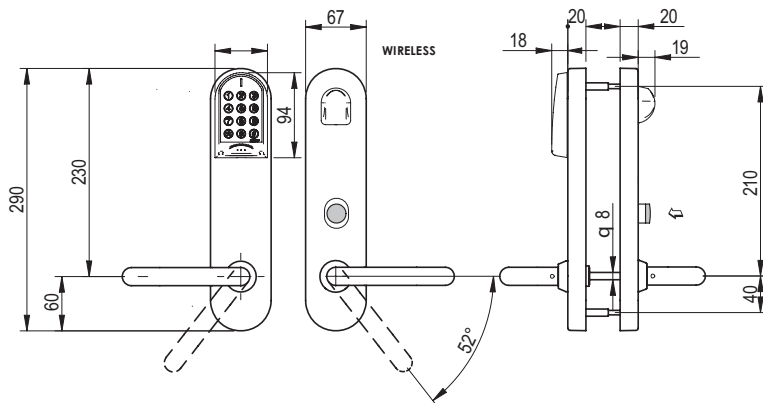

Technology	Escutcheon width	Function	Handle	Handle to thumbturn	Finish	Door thickness	Square spindle	Handing	Wireless option	Keypad option	Gain durability	
SB BLE MIFARE DESFire	6	56	U	00 No cylinder	IM	3 32-47 mm	8 8mm	-	-	K	-	
			L			-						
			W			-						
			H ²			-						
			Y ²		4 45-60mm	IP ²		-				
			S ^{1,2}					R/L ¹				
			B ²		6 60-75mm	PP		-				C
			P ²					-				
			O ¹		7 75-90mm	PM		R/L ¹				Convertible
			J					-				
SJ BLE HID iCLASS	6	56	T	00 No cylinder	IA	S 8mm split	-	W	Wireless	G Gain durability		
			G				-					
			N		9 90-105mm		NE ²				-	
			K ¹								R/L ¹	
			2 ²		1 105-120mm		BC ² BioCote				-	
			3 ²								-	
			4 ²								-	
5 ²			-									
7 ²			-									

Additional Prices - Gross prices





¹ For Handed lever handles, only for S, O or K handles.

² This option has an additional price please refer to the handles or finishes chapter.

Ref	Remarks	€
G	Gain durability	21,30

<p style="font-size: 1.2em; font-weight: bold;">Model Sx656xK</p>	<p>SALTO XS4 Electronic Escutcheon Sx656 with keypad, 2 Handles, any type and electronic “do not disturb” system.</p>
---	---

Prices - Gross prices		€						
	MIFARE DESFire	<table border="1" style="width: 100%; border-collapse: collapse;"> <tr> <td style="padding: 2px;">BLE MIFARE DESFire: Standard - standard square spindles, finishes and handles.</td> <td style="text-align: right; padding: 2px;">681,10</td> </tr> <tr> <td style="padding: 2px;">BLE MIFARE DESFire: Wireless convertible - standard square spindles, finishes and handles.</td> <td style="text-align: right; padding: 2px;">727,80</td> </tr> <tr> <td style="padding: 2px;">BLE MIFARE DESFire: Wireless - standard square spindles, finishes and handles.</td> <td style="text-align: right; padding: 2px;">845,10</td> </tr> </table>	BLE MIFARE DESFire: Standard - standard square spindles, finishes and handles.	681,10	BLE MIFARE DESFire: Wireless convertible - standard square spindles, finishes and handles.	727,80	BLE MIFARE DESFire: Wireless - standard square spindles, finishes and handles.	845,10
	BLE MIFARE DESFire: Standard - standard square spindles, finishes and handles.	681,10						
	BLE MIFARE DESFire: Wireless convertible - standard square spindles, finishes and handles.	727,80						
BLE MIFARE DESFire: Wireless - standard square spindles, finishes and handles.	845,10							
<table border="1" style="width: 100%; border-collapse: collapse;"> <tr> <td style="padding: 2px;">BLE HID iCLASS: Standard - standard square spindles, finishes and handles.</td> <td style="text-align: right; padding: 2px;">830,75</td> </tr> <tr> <td style="padding: 2px;">BLE HID iCLASS: Wireless convertible - standard square spindles, finishes and handles.</td> <td style="text-align: right; padding: 2px;">877,40</td> </tr> <tr> <td style="padding: 2px;">BLE HID iCLASS: Wireless - standard square spindles, finishes and handles.</td> <td style="text-align: right; padding: 2px;">994,55</td> </tr> </table>		BLE HID iCLASS: Standard - standard square spindles, finishes and handles.	830,75	BLE HID iCLASS: Wireless convertible - standard square spindles, finishes and handles.	877,40	BLE HID iCLASS: Wireless - standard square spindles, finishes and handles.	994,55	
BLE HID iCLASS: Standard - standard square spindles, finishes and handles.	830,75							
BLE HID iCLASS: Wireless convertible - standard square spindles, finishes and handles.	877,40							
BLE HID iCLASS: Wireless - standard square spindles, finishes and handles.	994,55							
								

Model Sx657xK

SALTO XS4 Electronic Escutcheon Sx657 with keypad,
2 Handles, any type, electronic “do not disturb” system & outside cylinder cutout.

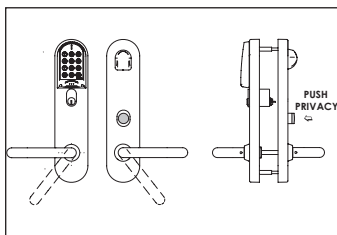

BLE MIFARE - DESFire
BLE HID iCLASS

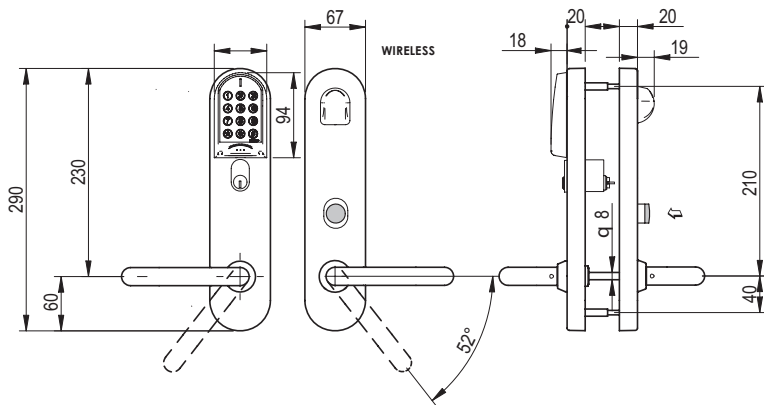

Technology	Escutcheon width	Function	Handle	Handle to thumbturn	Finish	Door thickness	Square spindle	Handing	Wireless option	Keypad option	Gain durability	
SB BLE MIFARE DESFire	6	57	U	05 no cylinder protection	IM	3 32-47 mm	8 8mm	-	-	K	-	
			L					-				
			W					-				
			H ²					-				
			Y ²		4 45-60mm	IP ²		-				
			S ^{1,2}					R/L ¹				
			B ²		6 60-75mm	PP		-				
			P ²					-				
			O ¹		7 75-90mm	PM		R/L ¹				C Convertible
			J					-				
SJ BLE HID iCLASS	6	57	T	05 no cylinder protection	IA	S 8mm split	-	-	W Wireless	G Gain durability		
			G				-					
			N		9 90-105mm		NE ²				-	
			K ¹								R/L ¹	
			2 ²		1 105-120mm		BC ² BioCote				-	
			3 ²								-	
			4 ²		-							
			5 ²		-							
7 ²	-											

Additional Prices - Gross prices





¹ For Handed lever handles, only for S, O or K handles.

² This option has an additional price please refer to the handles or finishes chapter.

Ref	Remarks	€
G	Gain durability	21,30

Model Sx657xK	SALTO XS4 Electronic Escutcheon Sx657 with keypad, 2 Handles, any type, electronic “do not disturb” system & outside cylinder cutout.
----------------------	---

Prices - Gross prices		€
 MIFARE DESFire	BLE MIFARE DESFire: Standard - standard square spindles, finishes and handles.	681,10
	BLE MIFARE DESFire: Wireless convertible - standard square spindles, finishes and handles.	727,80
	BLE MIFARE DESFire: Wireless - standard square spindles, finishes and handles.	845,10
<hr/>		
 	BLE HID iCLASS: Standard - standard square spindles, finishes and handles.	830,75
	BLE HID iCLASS: Wireless convertible - standard square spindles, finishes and handles.	877,40
	BLE HID iCLASS: Wireless - standard square spindles, finishes and handles.	994,55

Model E0400

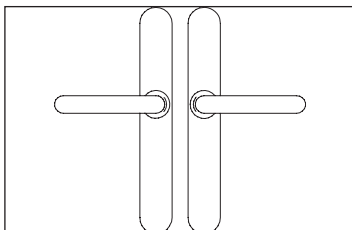

¹ For Handed lever handles, only for S, O or K handles.

² This option has an additional price, please refer to the handles or finishes chapter.

SALTO XS4 Electronic Escutcheon E040x, Complementary, 2 handles, any type.

Prices - Gross prices							€	
Standard - standard square spindles, finishes and handles.							118,30	
Standard - 9mm square spindle, finishes and handles.							147,00	
Technology	Escutcheon width	Function	Handle	Handle to thumbturn	Finish	Door thickness	Square spindle	
E0	4	00	U	00	IM	3 32-47 mm	7 7 mm	
			L					
			W					
			H ²					
			S ^{1,2}					
			B ²					
			P ²					
			O ¹					
			J					
			T					
			7F 72mm	PM	6 60-75mm	8 8 mm		
							Z	
							K ¹	
							2 ²	
							3 ²	
				NE ²	7 75-90mm	9 90-105mm	9 9 mm	
								4 ²
								5 ²
								7 ²
								BC ² BioCote
1 105-120mm								

Model E0401

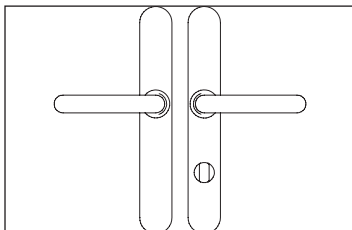

¹ For Handed lever handles, only for S, O or K handles.

² This option has an additional price, please refer to the handles or finishes chapter.

SALTO XS4 Electronic Escutcheon E040x, Complementary, 2 handles, any type.

Prices - Gross prices							€	
Standard - standard square spindles, finishes and handles.							151,55	
Standard - 9mm square spindle, finishes and handles.							180,35	
Technology	Escutcheon width	Function	Handle	Handle to thumbturn	Finish	Door thickness	Square spindle	
E0	4	01	U	47	IM	3 32-47 mm	7 7 mm	
			L					
			W					
			H ²					
			S ^{1,2}					
			B ²					
			P ²					
			O ¹					
			J	3R	PM	6 60-75mm		8 8 mm
			T	4R				
			Z	7R				
			K ¹	85				
			2 ²	88				
			NE ²	7 75-90mm	9 90-105mm	9 9 mm		
							3 ²	90
							4 ²	92
							9R	9R
							5 ²	10
			BC ² BioCote	1 105-120mm	1 105-120mm	9 9 mm		
							7 ²	11

Model E04C1

SALTO XS4 Electronic Escutcheon E040x, Complementary, 2 handles, any type, inside thumbturn, outside coin override.

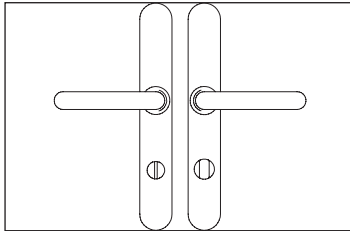

¹ For Handed lever handles, only for S, O or K handles.

² This option has an additional price, please refer to the handles or finishes chapter.

Prices - Gross prices							€
Standard - standard square spindles, finishes and handles.							164,50
Standard - 9mm square spindle, finishes and handles.							193,30
Technology	Escutcheon width	Function	Handle	Handle to thumbturn	Finish	Door thickness	Square spindle
E0	4	C1	U	70	IM	3 32-47 mm	7 7 mm
			L	72			
			W	7F			
			H ²	78	IP ²	4 45-60mm	8 8 mm
			S ^{1,2}	85			
			B ²	88	PP	6 60-75mm	9 9 mm
			P ²	90			
			O ¹	92	PM	7 75-90mm	
			J	10			
			T	11	IA	9 90-105mm	
			Z	3R			
			K ¹	4R	NE ²	1 105-120mm	
			2 ²	7R			
			3 ²	9R	BC ² BioCote		
			4 ²				
			5 ²				
			7 ²				

Model E0402

SALTO XS4 Electronic Escutcheon E040x, Complementary, 2 handles, any type, inside/outside cylinder cut out.

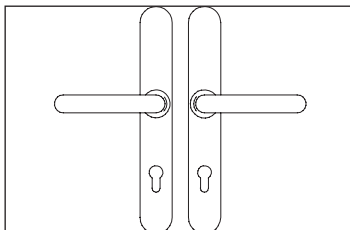

¹ For Handed lever handles, only for S, O or K handles.

² This option has an additional price, please refer to the handles or finishes chapter.

Prices - Gross prices							€
Standard - standard square spindles, finishes and handles.							127,45
Standard - 9mm square spindle, finishes and handles.							156,25
Technology	Escutcheon width	Function	Handle	Handle to thumbturn	Finish	Door thickness	Square spindle
E0	4	02	U	70	IM	3 32-47 mm	7 7 mm
			L	72			
			W	7F			
			H ²	78	IP ²	4 45-60mm	8 8 mm
			S ^{1,2}	85			
			B ²	88	PP	6 60-75mm	9 9 mm
			P ²	90			
			O ¹	92	PM	7 75-90mm	
			J	10			
			T	11	IA	9 90-105mm	
			Z	3R			
			K ¹	4R	NE ²	1 105-120mm	
			2 ²	7R			
			3 ²	9R	BC ² BioCote		
			4 ²				
			5 ²				
			7 ²				

Model E0403

SALTO XS4 Electronic Escutcheon E040x, Complementary, 2 handles, any type, inside thumbturn, inside cylinder cut out.

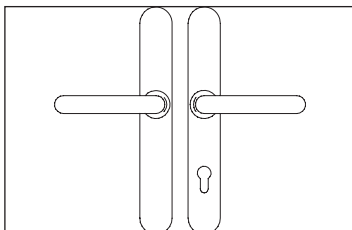

¹ For Handed lever handles, only for S, O or K handles.

² This option has an additional price, please refer to the handles or finishes chapter.

Prices - Gross prices							€
Standard - standard square spindles, finishes and handles.							127,45
Standard - 9mm square spindle, finishes and handles.							156,25
Technology	Escutcheon width	Function	Handle	Handle to thumbturn	Finish	Door thickness	Square spindle
E0	4	03	U	47	IM	3 32-47 mm	7 7 mm
			L	48			
			W	49			
			H ²	55	IP ²	4 45-60mm	
			S ^{1,2}	62			
			B ²	70			
			P ²	72	PP	6 60-75mm	8 8 mm
			O ¹	78			
			J	7F			
			T	3R	PM	7 75-90mm	
			Z	4R			
			K ¹	7R			
			2 ²	85	IA	9 90-105mm	9 9 mm
			3 ²	88			
			4 ²	90			
			5 ²	92	NE ²	1 105-120mm	
			7 ²	9R			
				10			
	11	BC ² BioCote					

Model E0404

SALTO XS4 Electronic Escutcheon E040x, Complementary, 2 handles, any type, outside cylinder cut out.

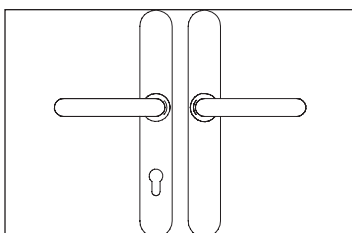

¹ For Handed lever handles, only for S, O or K handles.

² This option has an additional price, please refer to the handles or finishes chapter.

Prices - Gross prices							€
Standard - standard square spindles, finishes and handles.							127,45
Standard - 9mm square spindle, finishes and handles.							156,25
Technology	Escutcheon width	Function	Handle	Handle to thumbturn	Finish	Door thickness	Square spindle
E0	4	04	U	70	IM	3 32-47 mm	7 7 mm
			L	72			
			W	7F			
			H ²	78	IP ²	4 45-60mm	
			S ^{1,2}	85			
			B ²	88			
			P ²	90	PP	6 60-75mm	8 8 mm
			O ¹	92			
			J	10			
			T	3R	PM	7 75-90mm	
			Z	4R			
			K ¹	7R			
			2 ²	11	IA	9 90-105mm	9 9 mm
			3 ²	3R			
			4 ²	4R			
			5 ²	7R	NE ²	1 105-120mm	
			7 ²	9R			
		BC ² BioCote					

Model E0409

SALTO XS4 Electronic Escutcheon E040x, Complementary, One handle any type, outside knob, outside and inside cylinder cut out.

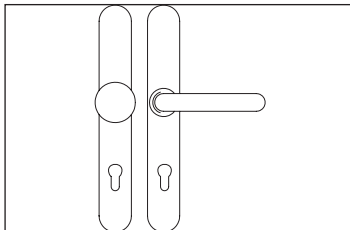

¹ For Handed lever handles, only for S, O or K handles.

² This option has an additional price, please refer to the handles or finishes chapter.

Prices - Gross prices	€
Standard - standard square spindles, finishes and handles.	137,70
Standard - 9mm square spindle, finishes and handles.	166,50

Technology	Escutcheon width	Function	Handle	Handle to thumbturn	Finish	Door thickness	Square spindle
E0	4	09	U	00	IM	3 32-47 mm	8 8 mm
			L	70			
			W	72			
			H ²	7F	IP ²	4 45-60mm	
			S ^{1,2}	78			
			B ²	85			
			P ²	88	PP	6 60-75mm	
			O ¹	90			
			J	92			
			T	92	PM	7 75-90mm	9 9 mm
			Z	10			
			K ¹	11			
			2 ²	3R	NE ²	9 90-105mm	
			3 ²	4R			
			4 ²	7R			
			5 ²	9R	BC ² BioCote	1 105-120mm	
			7 ²				

Model E0600

SALTO XS4 Electronic Escutcheon E060x, Complementary, 2 handles, any type.

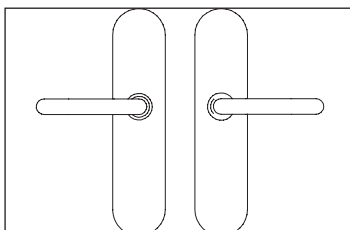

¹ For Handed lever handles, only for S, O or K handles.

² This option has an additional price, please refer to the handles or finishes chapter.

Prices - Gross prices	€
Standard - standard square spindles, finishes and handles.	130,15
Standard - 9mm square spindle, finishes and handles.	158,95

Technology	Escutcheon width	Function	Handle	Handle to thumbturn	Finish	Door thickness	Square spindle
E0	6	00	U	00	IM	3 32-47 mm	7 7 mm
			L				
			W				
			H ²		IP ²	4 45-60mm	
			S ^{1,2}				
			B ²				
			P ²	88	PP	6 60-75mm	
			O ¹	90			
			J	92			
			T	92	PM	7 75-90mm	8 8 mm
			Z	10			
			K ¹	11			
			2 ²	3R	NE ²	9 90-105mm	
			3 ²	4R			
			4 ²	7R			
			5 ²	9R	BC ² BioCote	1 105-120mm	
			7 ²				

Model E0601

SALTO XS4 Electronic Escutcheon E060x, Complementary, 2 handles, any type, inside thumbturn.

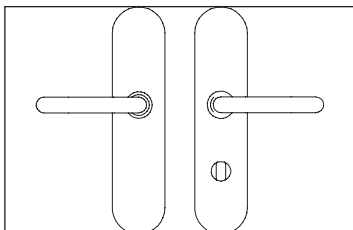

¹ For Handed lever handles, only for S, O or K handles.

² This option has an additional price, please refer to the handles or finishes chapter.

Prices - Gross prices							€	
Standard - standard square spindles, finishes and handles.							166,65	
Standard - 9mm square spindle, finishes and handles.							195,50	
Technology	Escutcheon width	Function	Handle	Handle to thumbturn	Finish	Door thickness	Square spindle	
E0	6	01	U	47	IM	3 32-47 mm	7 7 mm	
			L	48				
			W	49				
			H ²	55	IP ²	4 45-60mm		
			S ^{1,2}	70				
			B ²	72	PP	6 60-75mm		8 8 mm
			P ²	78				
			O ¹	7F				
			J	3R	PM	7 75-90mm	9 9 mm	
			T	4R				
			Z	7R				
			K ¹	85	IA	9 90-105mm		
			2 ²	88				
			3 ²	90	NE ²	1 105-120mm		
			4 ²	92				
			5 ²	9R	BC ² BioCote			
			7 ²	10				
			11					

Model E06C1

SALTO XS4 Electronic Escutcheon E060x, Complementary, 2 handles, any type, inside thumbturn, outside coin override.

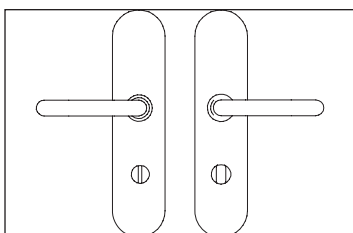

¹ For Handed lever handles, only for S, O or K handles.

² This option has an additional price, please refer to the handles or finishes chapter.

Prices - Gross prices							€	
Standard - standard square spindles, finishes and handles.							180,90	
Standard - 9mm square spindle, finishes and handles.							209,75	
Technology	Escutcheon width	Function	Handle	Handle to thumbturn	Finish	Door thickness	Square spindle	
E0	6	C1	U	70	IM	3 32-47 mm	7 7 mm	
			L	72				
			W	7F				
			H ²	78	IP ²	4 45-60mm		
			S ^{1,2}	85				
			B ²	88	PP	6 60-75mm		8 8 mm
			P ²	90				
			O ¹	92				
			J	10	PM	7 75-90mm	9 9 mm	
			T	11				
			Z	3R				
			K ¹	11	IA	9 90-105mm		
			2 ²	3R				
			3 ²	4R	NE ²	1 105-120mm		
			4 ²	4R				
			5 ²	7R	BC ² BioCote			
			7 ²	9R				

Model E0602

SALTO XS4 Electronic Escutcheon E060x, Complementary, 2 handles, any type, inside/outside cylinder cut out.

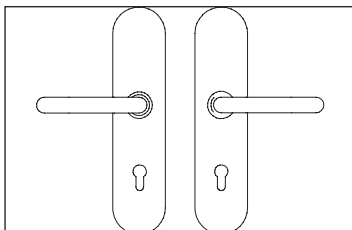

¹ For Handed lever handles, only for S, O or K handles.

² This option has an additional price, please refer to the handles or finishes chapter.

Prices - Gross prices							€
Standard - standard square spindles, finishes and handles.							140,25
Standard - 9mm square spindle, finishes and handles.							169,00
Technology	Escutcheon width	Function	Handle	Handle to thumbturn	Finish	Door thickness	Square spindle
E0	6	02	U	70	IM	3 32-47 mm	7 7 mm
			L	72			
			W	7F			
			H ²	78	IP ²	4 45-60mm	8 8 mm
			S ^{1,2}	85			
			B ²	88	PP	6 60-75mm	8 8 mm
			P ²	90			
			O ¹	92	PM	7 75-90mm	9 9 mm
			J	10			
			T	11	IA	9 90-105mm	9 9 mm
			Z	3R			
			K ¹	4R	NE ²	1 105-120mm	9 9 mm
			2 ²	7R			
			3 ²	9R	BC ² BioCote		
			4 ²				
			5 ²				
			7 ²				

Model E0603

SALTO XS4 Electronic Escutcheon E060x, Complementary, 2 handles, any type, inside cylinder cut out.

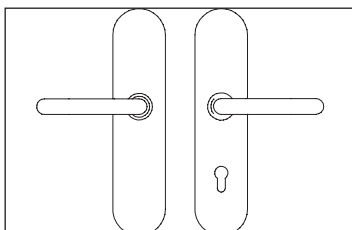

¹ For Handed lever handles, only for S, O or K handles.

² This option has an additional price, please refer to the handles or finishes chapter.

Prices - Gross prices							€
Standard - standard square spindles, finishes and handles.							140,25
Standard - 9mm square spindle, finishes and handles.							169,00
Technology	Escutcheon width	Function	Handle	Handle to thumbturn	Finish	Door thickness	Square spindle
E0	6	03	U	47	IM	3 32-47 mm	7 7 mm
			L	48			
			W	49			
			H ²	55	IP ²	4 45-60mm	8 8 mm
			S ^{1,2}	62			
			B ²	70	PP	6 60-75mm	8 8 mm
			P ²	72			
			O ¹	78	PM	7 75-90mm	9 9 mm
			J	7F			
			T	3R	IA	9 90-105mm	9 9 mm
			Z	4R			
			K ¹	7R	NE ²	1 105-120mm	9 9 mm
			2 ²	85			
			3 ²	88	BC ² BioCote		
			4 ²	90			
			5 ²	92			
			7 ²	9R			
	10						
	11						

Model E0604

SALTO XS4 Electronic Escutcheon E060x, Complementary, 2 handles, any type, outside cylinder cut out.

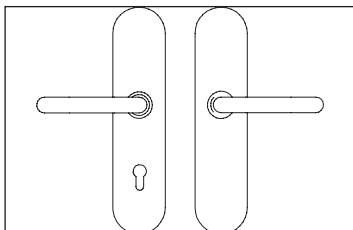

¹ For Handed lever handles, only for S, O or K handles.

² This option has an additional price, please refer to the handles or finishes chapter.

Prices - Gross prices	€
Standard - standard square spindles, finishes and handles.	140,25
Standard - 9mm square spindle, finishes and handles.	169,00

Technology	Escutcheon width	Function	Handle	Handle to thumbturn	Finish	Door thickness	Square spindle
E0	6	04	U	70	IM	3 32-47 mm	7 7 mm
			L	72			
			W	7F			
			H ²	78	IP ²	4 45-60mm	8 8 mm
			S ^{1,2}	85			
			B ²	88	PP	6 60-75mm	9 9 mm
			P ²	90			
			O ¹	92			
			J	10	PM	7 75-90mm	8 8 mm
			T	11			
			Z	11	IA	9 90-105mm	9 9 mm
			K ¹	3R			
			2 ²	4R	NE ²	1 105-120mm	9 9 mm
			3 ²	7R			
			4 ²	9R	BC ² BioCote		
			5 ²				
			7 ²				

Model E0609

SALTO XS4 Electronic Escutcheon E060x, Complementary, 2 Handles, any type, outside knob, outside and inside cylinder cut out.

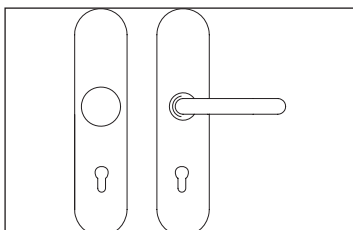

¹ For Handed lever handles, only for S, O or K handles.

² This option has an additional price, please refer to the handles or finishes chapter.

Prices - Gross prices	€
Standard - standard square spindles, finishes and handles.	151,55
Standard - 9mm square spindle, finishes and handles.	180,35

Technology	Escutcheon width	Function	Handle	Handle to thumbturn	Finish	Door thickness	Square spindle
E0	4	09	U	00	IM	3 32-47 mm	8 8 mm
			L	70			
			W	72			
			H ²	7F	IP ²	4 45-60mm	9 9 mm
			S ^{1,2}	78			
			B ²	85	PP	6 60-75mm	9 9 mm
			P ²	88			
			O ¹	90			
			J	92	PM	7 75-90mm	9 9 mm
			T	10			
			Z	11	IA	9 90-105mm	9 9 mm
			K ¹	3R			
			2 ²	4R	NE ²	1 105-120mm	9 9 mm
			3 ²	7R			
			4 ²	9R	BC ² BioCote		
			5 ²				
			7 ²				

Model A0600

SALTO XS4 Escutcheon A060x, Complementary,
For ANSI mortise locks, 2 handles, any type.

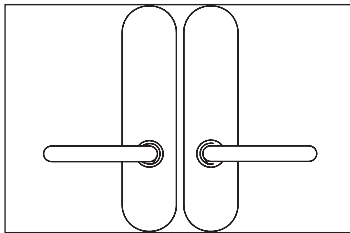

¹ For Handed lever handles, only for S, O, G or N handles.

² This option has an additional price, please refer to the handles or finishes chapter.

Prices - Gross prices	€
Standard - standard square spindles, finishes and handles.	130,15

Technology	Escutcheon width	Function	Handle	Handle to thumbturn	Finish	Door thickness	Square spindle	Handing
A0	6	00	U	00	IM	3 32-47 mm	8 8 mm	-
			L					-
			W					-
			H ²		IP ²	4 45-60mm		-
			S ^{1,2}					-
			B ²					R / L ¹
			P ²		PP	6 60-75mm		-
			O ¹					-
			J					-
			T		PM	7 75-90mm		R / L ¹
			G ¹					-
			Z					-
			N ¹		IA	9 90-105mm		R / L ¹
			A					-
			K ¹					-
			2 ²		NE ²	1 105-120mm		-
			3 ²					-
4 ²	-							
5 ²	BC ² BioCote		-					
7 ²			-					

Model A0608

SALTO XS4 Escutcheon A060x, Complementary,
For ANSI mortise locks, 2 handles, any type, inside thumbturn 90°.

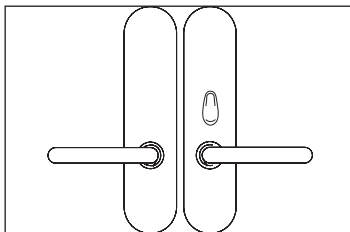

¹ For Handed lever handles, only for S, O, G or N handles.

² This option has an additional price, please refer to the handles or finishes chapter.

Prices - Gross prices	€
Standard - standard square spindles, finishes and handles.	166,65

Technology	Escutcheon width	Function	Handle	Handle to thumbturn	Finish	Door thickness	Square spindle	Handing
A0	6	08	U	61 61 mm	IM	3 32-47 mm	8 8 mm	-
			L					-
			W					-
			H ²		IP ²	4 45-60mm		-
			S ^{1,2}					-
			B ²					R / L ¹
			P ²		PP	6 60-75mm		-
			O ¹					-
			J					-
			T		PM	7 75-90mm		R / L ¹
			G ¹					-
			Z					-
			N ¹		IA	9 90-105mm		R / L ¹
			A					-
			K ¹					-
			2 ²		NE ²	1 105-120mm		-
			3 ²					-
4 ²	-							
5 ²	BC ² BioCote		-					
7 ²			-					

Model S0400

SALTO XS4 Complementary Escutcheon S040
2 handles, any type.

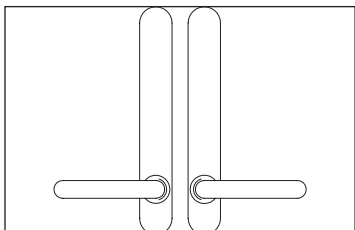

¹ For Handed lever handles, only for S, O or K handles.

² This option has an additional price, please refer to the handles or finishes chapter.

Prices - Gross prices	€
Standard - standard square spindles, finishes and handles.	133,25

Technology	Escutcheon width	Function	Handle	Handle to thumbturn	Finish	Door thickness	Square spindle	Handing
S0	4	00	U	00	IM	3 32-47 mm	8 8 mm	-
			L					-
			W					-
			H ²		IP ²	4 45-60mm		-
			S ^{1,2}					R / L ¹
			B ²					-
			P ²		PP	6 60-75mm		-
			O ¹					R / L ¹
			J		PM	7 75-90mm		-
			T					-
			G ¹					-
			N ¹					-
			K ¹		NE ²	9 90-105mm		R / L ¹
			2 ²					-
			3 ²					-
			4 ²					-
5 ²	-							
7 ²	BC ² BioCote	1 105-120mm	-					

Model S0401

SALTO XS4 Complementary Escutcheon S040
2 handles, any type. Inside thumbturn.

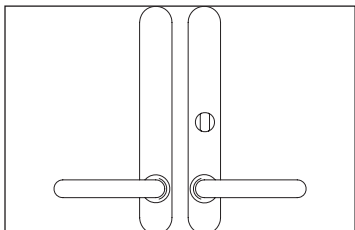

¹ For Handed lever handles, only for S, O or K handles.

² This option has an additional price, please refer to the handles or finishes chapter.

Prices - Gross prices	€
Standard - standard square spindles, finishes and handles.	159,80

Technology	Escutcheon width	Function	Handle	Handle to thumbturn	Finish	Door thickness	Square spindle	Handing
S0	4	01	U	05	IM	3 32-47 mm	8 8 mm	-
			L					-
			W					-
			H ²		IP ²	4 45-60mm		-
			S ^{1,2}					R / L ¹
			B ²					-
			P ²		PP	6 60-75mm		-
			O ¹					R / L ¹
			J		PM	7 75-90mm		-
			T					-
			G ¹					-
			N ¹					-
			K ¹		NE ²	9 90-105mm		R / L ¹
			2 ²					-
			3 ²					-
			4 ²					-
5 ²	-							
7 ²	BC ² BioCote	1 105-120mm	-					

Model S0404

SALTO XS4 Complementary Escutcheon S040x,
2 handles, any type. Outside cylinder cutout.

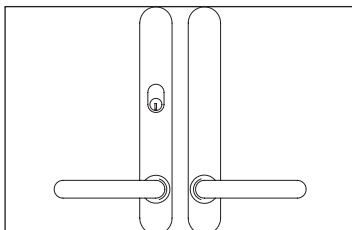

¹ For Handed lever handles, only for S, O or K handles.

² This option has an additional price, please refer to the handles or finishes chapter.

Prices - Gross prices								€
Standard - standard square spindles, finishes and handles.								138,60
Technology	Escutcheon width	Function	Handle	Handle to thumbturn	Finish	Door thickness	Square spindle	Handing
S0	4	04	U	05	IM	3 32-47 mm	8 8 mm	-
			L					-
			W					-
			H ²		IP ²	4 45-60mm		-
			S ^{1,2}					R / L ¹
			B ²					-
			P ²		PP	6 60-75mm		-
			O ¹					R / L ¹
			J					-
			T		PM	7 75-90mm		-
			G ¹					-
			N ¹					-
			K ¹		NE ²	9 90-105mm		R / L ¹
			2 ²					-
			3 ²					-
			4 ²		BC ² BioCote	1 105-120mm		-
5 ²	-							
7 ²	-							

Model S0405

SALTO XS4 Complementary Escutcheon S040
2 handles, any type. Inside thumbturn. Outside cylinder cutout.

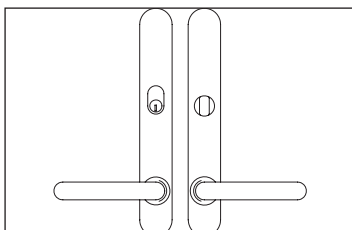

¹ For Handed lever handles, only for S, O or K handles.

² This option has an additional price, please refer to the handles or finishes chapter.

Prices - Gross prices								€
Standard - standard square spindles, finishes and handles.								162,80
Technology	Escutcheon width	Function	Handle	Handle to thumbturn	Finish	Door thickness	Square spindle	Handing
S0	4	05	U	05	IM	3 32-47 mm	8 8 mm	-
			L					-
			W					-
			H ²		IP ²	4 45-60mm		-
			S ^{1,2}					R / L ¹
			B ²					-
			P ²		PP	6 60-75mm		-
			O ¹					R / L ¹
			J					-
			T		PM	7 75-90mm		-
			G ¹					-
			N ¹					-
			K ¹		NE ²	9 90-105mm		R / L ¹
			2 ²					-
			3 ²					-
			4 ²		BC ² BioCote	1 105-120mm		-
5 ²	-							
7 ²	-							

Model S0600

SALTO XS4 Complementary Escutcheon S060, 2 handles, any type.

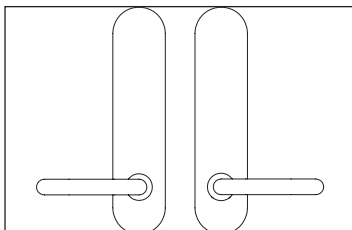

¹ For Handed lever handles, only for S, O or K handles.

² This option has an additional price, please refer to the handles or finishes chapter.

Prices - Gross prices	€
Standard - standard square spindles, finishes and handles.	145,95

Technology	Escutcheon width	Function	Handle	Handle to thumbturn	Finish	Door thickness	Square spindle	Handing
S0	6	00	U	00	IM	3 32-47 mm	8 8 mm	-
			L					-
			W					-
			H ²		IP ²	4 45-60mm		-
			S ^{1,2}					R / L ¹
			B ²					-
			P ²		PP	6 60-75mm		-
			O ¹					R / L ¹
			J		PM	7 75-90mm		-
			T					-
			G ¹					-
			N ¹		IA	9 90-105mm		-
			K ¹					-
			2 ²		NE ²	1 105-120mm		R / L ¹
			3 ²					-
			4 ²					-
5 ²	-							
7 ²	BC ² BioCote	-						

Model S0601

SALTO XS4 Complementary Escutcheon S060, 2 handles, any type. Inside thumbturn.

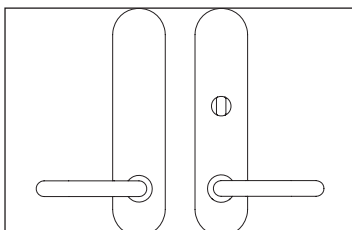

¹ For Handed lever handles, only for S, O or K handles.

² This option has an additional price, please refer to the handles or finishes chapter.

Prices - Gross prices	€
Standard - standard square spindles, finishes and handles.	174,90

Technology	Escutcheon width	Function	Handle	Handle to thumbturn	Finish	Door thickness	Square spindle	Handing
S0	6	01	U	05	IM	3 32-47 mm	8 8 mm	-
			L					-
			W					-
			H ²		IP ²	4 45-60mm		-
			S ^{1,2}					R / L ¹
			B ²					-
			P ²		PP	6 60-75mm		-
			O ¹					R / L ¹
			J		PM	7 75-90mm		-
			T					-
			G ¹					-
			N ¹		IA	9 90-105mm		-
			K ¹					-
			2 ²		NE ²	1 105-120mm		R / L ¹
			3 ²					-
			4 ²					-
5 ²	-							
7 ²	BC ² BioCote	-						

Model S0604

SALTO XS4 Complementary Escutcheon S060, 2 handles, any type. Outside cylinder cutout.

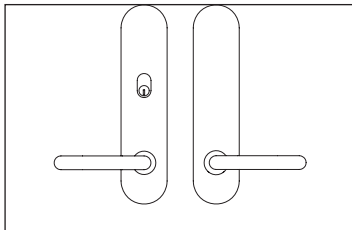

¹ For Handed lever handles, only for S, O or K handles.

² This option has an additional price, please refer to the handles or finishes chapter.

Prices - Gross prices								€
Standard - standard square spindles, finishes and handles.								151,65
Technology	Escutcheon width	Function	Handle	Handle to thumbturn	Finish	Door thickness	Square spindle	Handing
S0	6	04	U	05	IM	3 32-47 mm	8 8 mm	-
			L					-
			W					-
			H ²		IP ²	4 45-60mm		-
			S ^{1,2}					R / L ¹
			B ²					-
			P ²		PP	6 60-75mm		-
			O ¹					R / L ¹
			J					-
			T		PM	7 75-90mm		-
			G ¹					-
			N ¹					-
			K ¹		NE ²	9 90-105mm		R / L ¹
			2 ²					-
			3 ²					-
			4 ²		BC ² BioCote	1 105-120mm		-
			5 ²					-
7 ²	-							

Model S0605



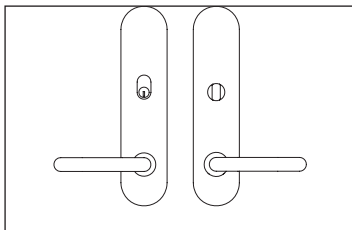

SALTO XS4 Complementary Escutcheon S060, 2 handles, any type. Inside thumbturn. Outside cylinder cutout.



¹ For Handed lever handles, only for S, O or K handles.

² This option has an additional price, please refer to the handles or finishes chapter.

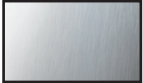
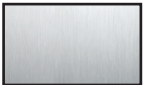
Prices - Gross prices								€
Standard - standard square spindles, finishes and handles.								177,75
Technology	Escutcheon width	Function	Handle	Handle to thumbturn	Finish	Door thickness	Square spindle	Handing
S0	6	05	U	05	IM	3 32-47 mm	8 8 mm	-
			L					-
			W					-
			H ²		IP ²	4 45-60mm		-
			S ^{1,2}					R / L ¹
			B ²					-
			P ²		PP	6 60-75mm		-
			O ¹					R / L ¹
			J					-
			T		PM	7 75-90mm		-
			G ¹					-
			N ¹					-
			K ¹		NE ²	9 90-105mm		R / L ¹
			2 ²					-
			3 ²					-
			4 ²		BC ² BioCote	1 105-120mm		-
			5 ²					-
7 ²	-							

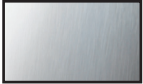
Product description	Product reference	€
Brass finishes		
Polished brass Cover plates made of stainless steel with a PVD coating. Handles made of stainless steel with a PVD coating except O handle which is made in brass with PVD coating.		E X X X X X X P P X X
Antique brass Cover plates made of stainless steel with a special finish simulating antique brass.		E X X X X X X I A X X
Satin brass Cover plates made of stainless steel with a PVD coating. Handles made of stainless steel with a PVD coating except O handle which is made in brass with PVD coating.		E X X X X X X P M X X
Stainless steel finishes		
Satin stainless steel		E X X X X X X I M X X
Polished stainless steel		E X X X X X X I P X X
RAL colours		
Black		E X X X X X X N E X X
BioCote antimicrobial finishes		
SALTO BioCote finish Cover plates made of stainless steel with a Biocote antimicrobial coating.		E X X X X X X BC X X

Example of price calculation for finishes other than Satin Stainless (IM), which is the standard used in our price list.

Required is E9450U00NE1 escutcheon.	€
E9450U00IM1	464,70
Additional price for Black finish	24,90
Total Price:	489,60

 Please note that brass finishes may become discoloured over time due to their exposure to environmental conditions such as humidity, pollution and salt air. Rings and keys can also scratch the brass lacquer finish and once this has started to occur, discolouration will likely begin.

Escutcheon handles

Only those handles regarded as off-set handles have an add-on to the price of the standard escutcheon. 2 remarks:

- Prices are gross and per handle, so an E9450 model, for instance, needs 2 handles in the case of an off-set model.
- Prices refer to the IM finish, so please refer to the finishes pricelist in order to establish final price of the product.

FINISH MODEL		PVD							Spindle available			Gross price €
		SATIN STAINLESS STEEL	POLISHED STAINLESS STEEL	POLISHED BRASS COLOUR	SATIN BRASS COLOUR	ANTIQUE BRASS COLOUR	BLACK	BIOCOTE	DUAL 8-7Diamond	8	9	
		IM	IP	PP	PM	IA	NE	BC				
	U	✓	✓	✓	✓	✓	✓	✓		✓	✓	0,00
	L	✓	✓	✓	✓	✓	✓	✓	✓	✓	✓	0,00
	W	✓	✓	✓	✓	✓	✓	✓		✓	✓	0,00
	H	✓								✓	✓	30,15
	S	✓								✓		30,15
	B	✓								✓		71,05
	P	✓								✓		44,35
	J	✓			✓	✓	✓	✓		✓	✓	0,00
	T	✓			✓					✓		0,00
	Y	✓	✓							✓		30,15
	Z	✓			✓					✓		0,00
	O	✓	✓	✓	✓	✓	✓	✓		✓		0,00
	N	✓			✓					✓		0,00
	A	✓	✓	✓	✓	✓	✓	✓	✓			0,00
	G	✓			✓					✓		30,15
	K	✓	✓	✓						✓		0,00
	I	✓								✓	✓	30,15
	2	✓	✓	✓						✓		37,30
	3	✓	✓	✓						✓		37,30
	4	✓	✓	✓						✓		37,30
	7	✓	✓	✓						✓		37,30
	5	✓	✓	✓						✓		37,30

*All handles are made from Stainless Steel, except the "O" handle which is Brass and the K, 2, 3, 4, 5 and 7 are made of Zamack.

The Y handle, means Y on the outside and W on the inside. The I handle, means I on the outside and J on the inside.

The Z handle, means "Inside handle fixed only with a socket set screw"



SALTO escutcheon reference example

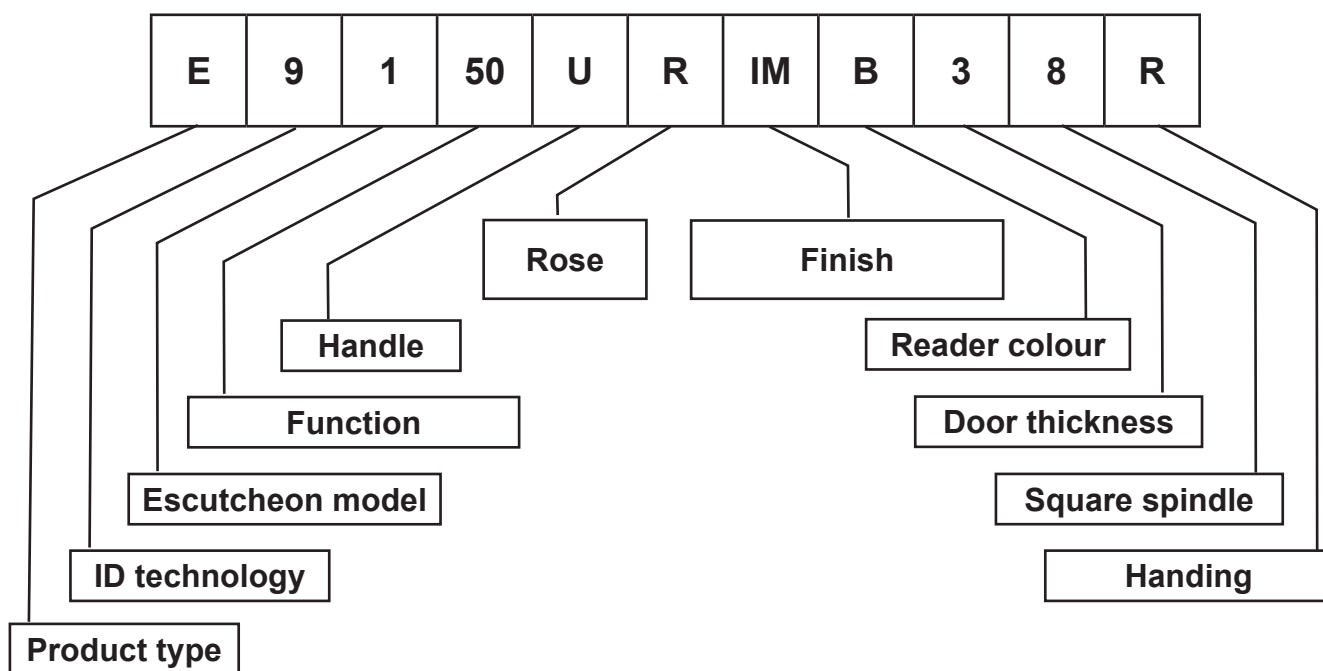

Product type:

E = European escutcheon

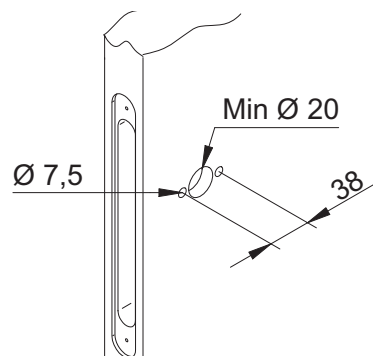
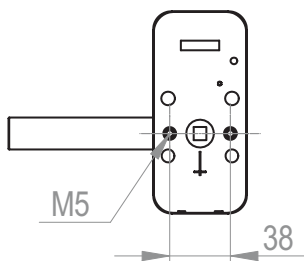
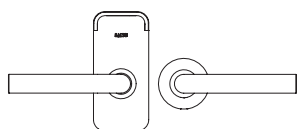

ID technology

RFID

9 = Contactless Mifare /DESFire
 B = Contactless BLE Mifare /DESFire
 J = Contactless BLE HID iCLASS



MIFARE
DESFire



Escutcheon

width:

1 = XS4 Mini

Function:

50 = Outside reader

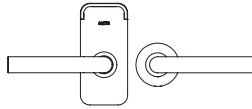

Outside reader

Handles

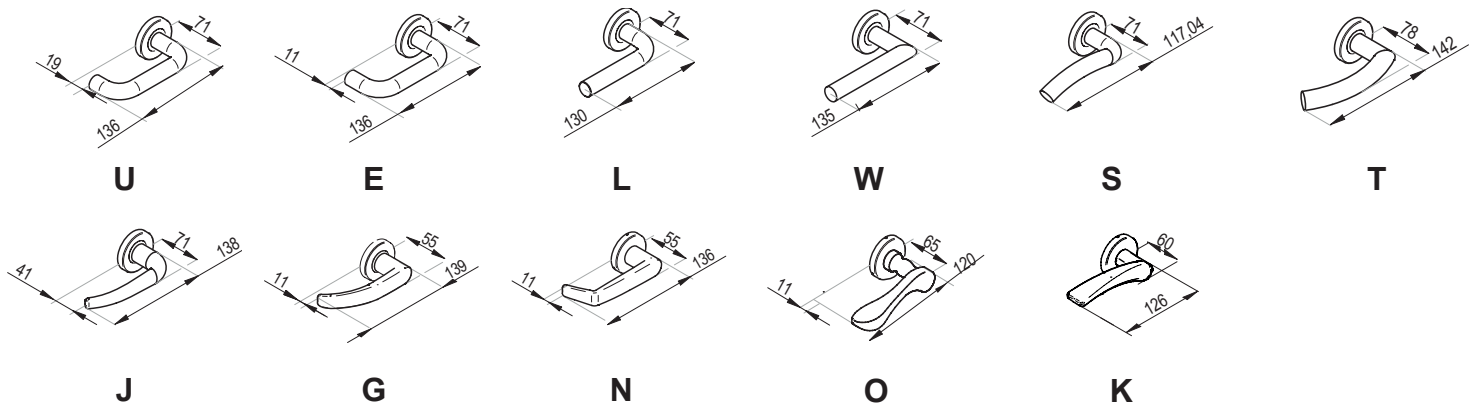

Inside configuration rose:

R = Handle on rose included

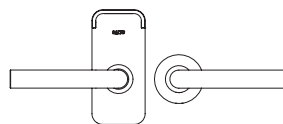

Inside rose included

Handle finishes

IM = Satin stainless steel
 IP = Bright stainless steel
 PP = Bright Brass
 PM = Satin Brass

IA = Antique Brass
 NE = Black
 BC = BioCote - antimicrobial finish



Satin stainless steel



Bright stainless steel

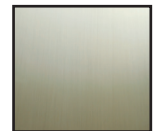

Bright Brass PVD



Satin Brass PVD



Antique Brass



Black



BioCote finish



The BioCote and IA finish is 'painted' and sharp objects such as rings and other metallic objects as well as harsh and abrasive chemicals should be avoided during any cleaning process.

Reader Colour:

B = Black reader cover
W = White reader cover



Black reader cover



White reader cover

Door thickness

- 3** = 35 - 50mm.
 - 4** = 47 - 60mm.
 - 5** = 57 - 70mm.
 - 6** = 67 - 80mm.
 - 7** = 77 - 90mm.
 - 9** = 87-100mm.
- 0** = 97 - 110mm.
 - 1** = 107 - 120mm.

Square spindle

- 8** = 8 mm.
- 9** = 9 mm.

Handle handing

R = Right hand.
L = Left hand.
 for handed handles and models Sx170

R	Right hand
L	Left hand

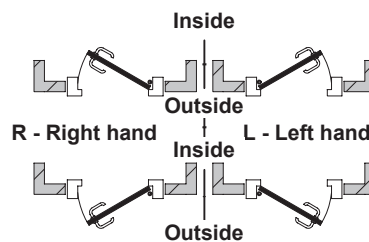

Model Ex150	SALTO XS4 Mini Escutcheon Ex150, for European mortise locks 2 Handles, any type.
--------------------	---

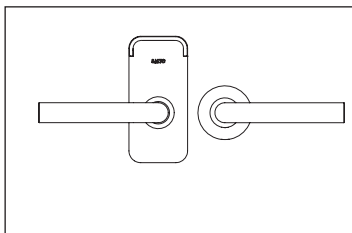

Mifare DESFire BLE
Mifare DESFire
HID iCLASS BLE

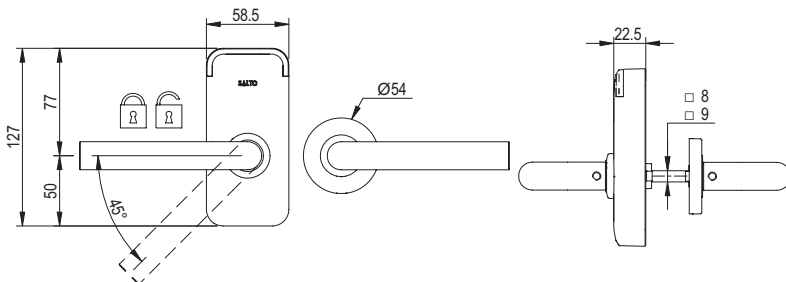

Prices - Gross prices		€
	BLE Mifare DESFire: Standard - standard square spindles, finishes and handles.	387,95
	BLE Mifare DESFire: Standard - 9mm square spindle, finishes and handles.	416,10
	Mifare DESFire: Standard - standard square spindles, finishes and handles.	360,25
	Mifare DESFire: Standard - 9mm square spindle, finishes and handles.	388,45
	BLE HID iCLASS: Standard - standard square spindles, finishes and handles.	496,60
	BLE HID iCLASS: Standard - 9mm square spindle, finishes and handles.	532,60

Technology	Escutcheon width	Function	Handle	Inside rose configuration	Handle finish	Reader colour	Door thickness	Square spindle	Handing	
E9 Prox. Mifare DESFire	1	50	U	R	IM	B Black cover	3	7 7mm	-	
			L				35-50mm		-	
			W				4		47-60mm	R/L ¹
			S ^{1,2}				5		57-70mm	-
EB Prox. BLE Mifare DESFire			T		6		8 8mm	-		
			J		67-80mm			-		
			G ¹		7			77-90mm	-	
			N ¹		9			87-100mm	R/L ¹	
EJ Prox. BLE HID iCLASS			E		W White cover	9mm	-			
			O ¹				0	97-110mm	-	
			K ¹				1	107-120mm	-	
							BC ² BioCote			



¹ For Handed lever handles, only for K and S handles.

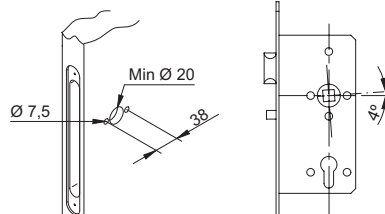

² This option has an additional price please refer to the handles or finishes chapter.





To be used in combination with a DIN mortise lock or SALTO LE8P mortise locks

Product description	Product reference	€
---------------------	-------------------	---

Stainless steel finishes

Satin stainless steel 	E X X X X X X I M X X	0,00
Polished stainless steel 	E X X X X X X I P X X	15,70

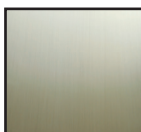
Brass finishes

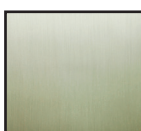
Polished brass Cover plates made of stainless steel with a PVD coating. Handles made of stainless steel with a PVD coating except O handle which is made in brass with PVD coating. 	E X X X X X X P P X X	0,00
Antique brass Cover plates made of stainless steel with a special finish simulating antique brass. 	E X X X X X X I A X X	0,00
Satin brass Cover plates made of stainless steel with a PVD coating. Handles made of stainless steel with a PVD coating except O handle which is made in brass with PVD coating. 	E X X X X X X P M X X	0,00

RAL colours

Black 	E X X X X X X N E X X	24,90
--	-----------------------	-------

BioCote antimicrobial finishe

SALTO BioCote finish Cover plates made of stainless steel with a Biocote antimicrobial coating. 	E X X X X X X B C X X	40,80
--	-----------------------	-------

Example of price calculation for finishes other than Satin Stainless (IM), which is the standard used in our price list.

Required is E9150URNEB38 escutcheon.	€
E9150URIMB38	360,25
Additional price for Black finish	24,90
Total Price:	385,15

Only those handles regarded as off-set handles have an add-on to the price of the standard escutcheon. 2 remarks:

- Prices are gross and per handle, so an E9150 model, for instance, needs 2 handles in the case of an off-set model.
- Prices refer to the IM finish, so please refer to the finishes pricelist in order to establish final price of the product.

Finish Model		PVD							Spindle available		Gross price €
		Satin stainless steel	Polished stainless steel	Polished brass colour	Satin brass colour	Antique brass colour	Black	BioCote	8 <input type="checkbox"/>	9 <input type="checkbox"/>	
		IM	IP	PP	PM	IA	NE	BC			
	U	✓	✓	✓	✓	✓	✓	✓	✓	✓	0,00
	L	✓	✓	✓	✓	✓	✓	✓	✓	✓	0,00
	W	✓	✓	✓	✓	✓	✓	✓	✓	✓	0,00
	E	✓	✓	✓	✓	✓	✓	✓	✓		0,00
	S	✓					✓	✓	✓		30,15
	T	✓			✓		✓	✓	✓		0,00
	J	✓			✓	✓	✓	✓	✓	✓	0,00
	G	✓			✓		✓	✓	✓		30,15
	N	✓			✓		✓	✓	✓		0,00
	O	✓	✓	✓	✓	✓	✓		✓		0,00
	K	✓	✓	✓					✓		0,00

Model SP221457

SALTO XS4 MINI mounting tool

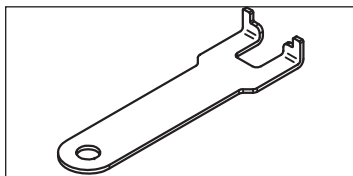

Prices - Gross prices		€
Description	Reference	
SALTO XS4 MINI mounting tool	S P 2 2 1 4 5 7	2,40

Model LE8P12

SALTO European mortise lock with projected latch and deadbolt. (axe distance 85mm). Steel mortise lock with reversible projection latch. The auxiliary latch (anticard) projects and deadlocks the latch and the lever retracts deadbolt and latch simultaneously (panic function).

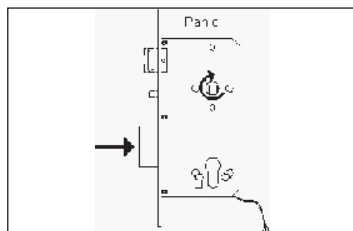

Prices - Gross prices		€
Standard front plate price - any finish		53,30
Ansi front plate price - any finish		74,50

Mortise lock EN 12209 Grade 3 and EN 179 Grade 3 (combined with XS4 handle sets, U or H model handles) high frequency of use with little incentive to exercise care, public buildings. With Dead-bolt detector (privacy detector).

EN-1634 certificated Ei 60 and UL 90 in composite core door. Included screws in IM finish in any case.

Model	Backset	Front plate		Detector	Finish	Square spindle	Handing
		Shape	Size				
LE8P12	50	C Squared	0 20 mm	3 Privacy detector (for XS4MINI)	IM	8	- reversible
		R Round	3 23 mm				
	60	A ANSI type	7 27 mm for A shape				
			2 32 mm for A shape				
	70						

* Not all the front plate shapes and dimensions are possible. If the front plate shape is R (round) or C (squared) the size must be 0 (20mm.) or 3 (23mm.) If the front plate shape is A (ANSI type) the size must be 7 (27mm.) or 2 (32mm.)

Model HT

SALTO Rose Accessory model HT
 Round rose, with PZ cut out on the inside to be used with TE010 privacy thumbturn.

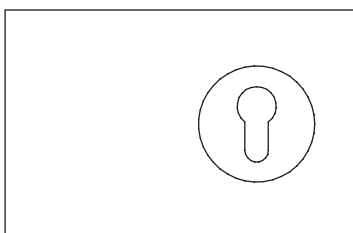

Prices - Gross prices		€
Description	Reference	
SALTO Rose model HT - satin stainless steel type finish	R S H T R I M	11,50
SALTO Rose model HT-Bright stainless steel type finish	R S H T R I P	12,55
SALTO Rose model HT - PVD bright brass type finish	R S H T R P P	20,75
SALTO Rose model HT - PVD satin brass type finish	R S H T R P M	19,90
SALTO Rose model HT - Antique brass type finish	R S H T R I A	18,45
SALTO Rose model HT - Black chromium type finish	R S H T R N E	18,45
SALTO Rose model HT - BioCote type finish	R S H T R B C	20,75

Available for European mortise locks.



IM

Satin stainless steel type

Rose	Manufacturer	Model	Format	Finish
R	S SALTO	HT	R Round	IM
				IP
				PP
				PM
				IA
				NE
				BC

Model PH

SALTO Rose Accessory model PH
 Round rose, with PZ cut out on the outside.

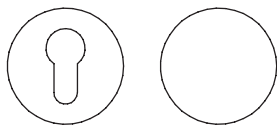

Available for European mortise locks.

Prices - Gross prices

Description	Reference	€
SALTO Rose model PH - satin stainless steel type finish	R S P H R I M 3	11,50
SALTO Rose model PH-Bright stainless steel type finish	R S P H R I P 3	12,55
SALTO Rose model PH - PVD bright brass type finish	R S P H R P P 3	20,75
SALTO Rose model PH- PVD satin brass type finish	R S P H R P M 3	19,90
SALTO Rose model PH - Antique brass type finish	R S P H R I A 3	18,45
SALTO Rose model PH - Black chromium type finish	R S P H R N E 3	18,45
SALTO Rose model PH - BioCote type finish	R S P H R B C 3	20,75

Rose	Manufacturer	Model	Format	Finish	Door thickness
R	S SALTO	PH	R	IM	3 37 < t < 50mm
				IP	
				PP	
				PM	
				5 50 < t < 70mm	IA
					NE
					BC



IM
Satin stainless steel
type

Model PZ

SALTO Rose Accessory model PZ
 Round rose, with PZ cut out on the outside and on the inside.

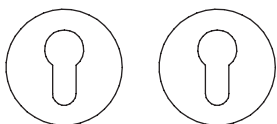

Available for European mortise locks.

Prices - Gross prices

Description	Reference	€
SALTO Rose model PZ - satin stainless steel type finish	R S P Z R I M 3	11,50
SALTO Rose model PZ-Bright stainless steel type finish	R S P Z R I P 3	12,55
SALTO Rose model PZ - PVD bright brass type finish	R S P Z R P P 3	20,75
SALTO Rose model PZ- PVD satin brass type finish	R S P Z R P M 3	19,90
SALTO Rose model PZ - Antique brass type finish	R S P Z R I A 3	18,45
SALTO Rose model PZ - Black chromium type finish	R S P Z R N E 3	18,45
SALTO Rose model PZ - BioCote type finish	R S P Z R B C 3	20,75

Rose	Manufacturer	Model	Format	Finish	Door thickness
R	S SALTO	PZ	R	IM	3 37 < t < 50mm
				IP	
				PP	
				PM	
				5 50 < t < 70mm	IA
					NE
					BC



IM
Satin stainless steel
type

Model TE010

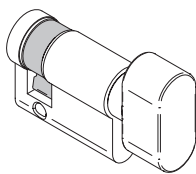

SALTO Privacy thumbturn for XS4Mini European.

PZ profile. To be used in combination with the SALTO European mortise locks for Ex150 XS4 Mini.

Prices - Gross prices	€
TE010H - Satin Nickel finish	
TE010H30NM - Thumbturn 30,5mm internal length.	20,75
TE010H35NM - Thumbturn 35,5mm internal length.	22,25
TE010H40NM - Thumbturn 40,5mm internal length.	22,60
TE010H45NM - Thumbturn 45,5mm internal length.	23,90
TE010H50NM - Thumbturn 50,5mm internal length.	24,90
TE010H - Polished Nickel finish	
TE010H30IP - Thumbturn 30,5mm internal length.	20,15
TE010H35IP - Thumbturn 35,5mm internal length.	21,15
TE010H40IP - Thumbturn 40,5mm internal length.	21,95
TE010H45IP - Thumbturn 45,5mm internal length.	23,25
TE010H50IP - Thumbturn 50,5mm internal length.	24,15
TE010H - Satin Brass colour finish	
TE010H30PM - Thumbturn 30,5mm internal length.	28,85
TE010H35PM - Thumbturn 35,5mm internal length.	29,90
TE010H40PM - Thumbturn 40,5mm internal length.	30,40
TE010H45PM - Thumbturn 45,5mm internal length.	32,10
TE010H50PM - Thumbturn 50,5mm internal length.	33,05
TE010H - Polished Brass colour finish	
TE010H30PP - Thumbturn 30,5mm internal length.	28,85
TE010H35PP - Thumbturn 35,5mm internal length.	29,90
TE010H40PP - Thumbturn 40,5mm internal length.	30,40
TE010H45PP - Thumbturn 45,5mm internal length.	32,10
TE010H50PP - Thumbturn 50,5mm internal length.	33,05
TE010H - Black chromium colour finish	
TE010H30NE - Thumbturn 30,5mm internal length.	30,50
TE010H35NE - Thumbturn 35,5mm internal length.	31,75
TE010H40NE - Thumbturn 40,5mm internal length.	33,15
TE010H45NE - Thumbturn 45,5mm internal length.	34,45
TE010H50NE - Thumbturn 50,5mm internal length.	35,80
TE010H - BioCote finish	
TE010H30BC - Thumbturn 30,5mm internal length.	30,50
TE010H35BC - Thumbturn 35,5mm internal length.	31,75
TE010H40BC - Thumbturn 40,5mm internal length.	33,15
TE010H45BC - Thumbturn 45,5mm internal length.	34,45
TE010H50BC - Thumbturn 50,5mm internal length.	35,80

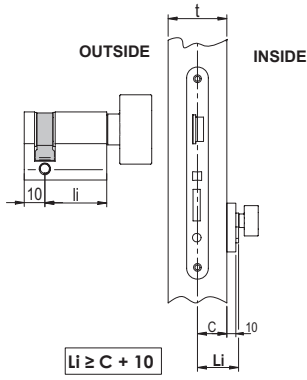

Product	Model	Outside length	Thumbturn	Internal length	Finish
T	E0	10	H	30 (30,5mm)	NM Satin nickel
				35 (35,5mm)	IP Polished nickel plated
				40 (40,5mm)	PM Satin brass colour
				45 (45,5mm)	PP Polished brass colour
				50 (50,5mm)	NE Black chromium
				BC BioCote	

**Cover Plate 059
(DIN 72)**

SALTO XS4 Mini cover plate, for Ex150 range to retrofit doors that were equipped with DIN mortise locks.
 Made of steel. The set includes 2 plates (inside and outside)

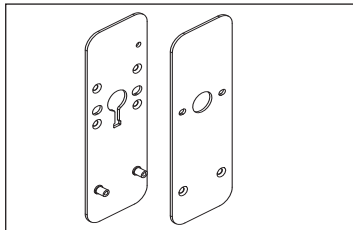

Prices - Gross prices				€
Model	Width	Finish	Special plates	
COPLEM	0 5 9	I M	7 2	56,35
COPLEM	0 5 9	I P	7 2	56,35
COPLEM	0 5 9	P P	7 2	111,15
COPLEM	0 5 9	P M	7 2	111,15
COPLEM	0 5 9	I A	7 2	111,15
COPLEM	0 5 9	N E	7 2	111,15

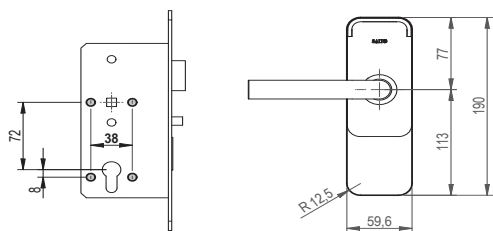

**Cover Plate 059
(PZ 85)**

SALTO XS4 Mini cover plate, for Ex150 range to retrofit doors that were equipped with European mortise locks (axe distances 85mm).
 Made of steel. The set includes 2 plates (inside and outside)

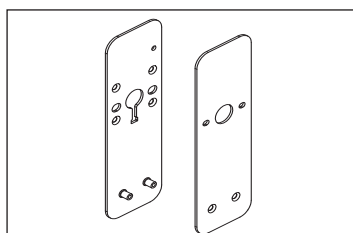

Prices - Gross prices				€
Model	Width	Finish	Special plates	
COPLEM	0 5 9	I M	8 5	56,35
COPLEM	0 5 9	I P	8 5	56,35
COPLEM	0 5 9	P P	8 5	111,15
COPLEM	0 5 9	P M	8 5	111,15
COPLEM	0 5 9	I A	8 5	111,15
COPLEM	0 5 9	N E	8 5	111,15

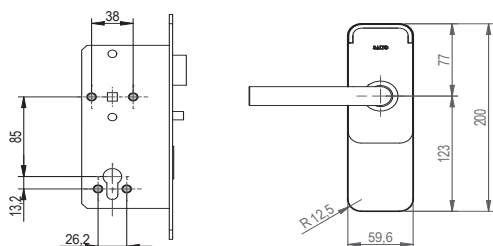

Cover Plate Mini custom

SALTO CUSTOM Cover-all Plates for SALTO XS4MINI

If you need a special cover plate you can request it by sending back all the info detailed on the chart below, and SALTO will send you the quotation for this customization service.

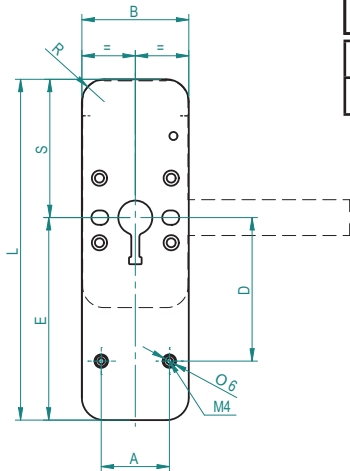

Prices - Gross prices				€
Model	Width	Finish	Special plates	
COPLEM		C U S T O M		Upon request

Symmetrical	Dimensions							Quant.	Finish
	R	B	L	S	E	D	A		
	(Min=2mm)								



SALTO escutcheon reference example

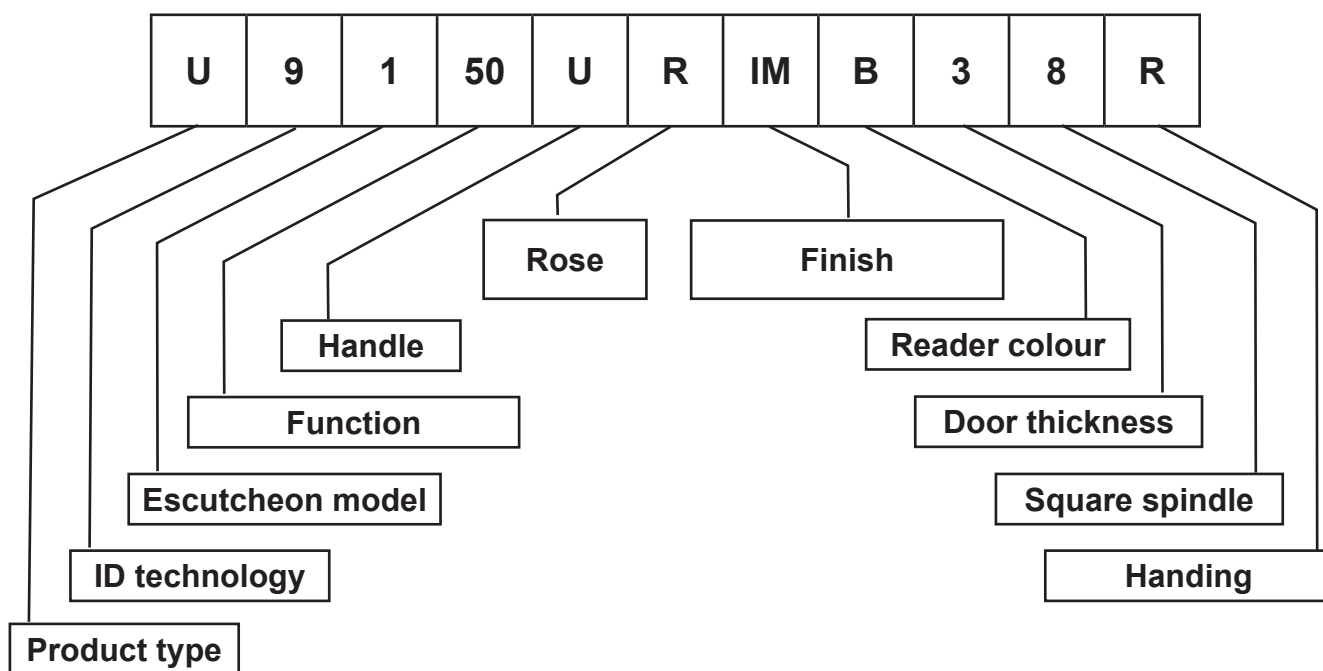

Product type:

U = Escutcheon Compatible with Australian mortise locks

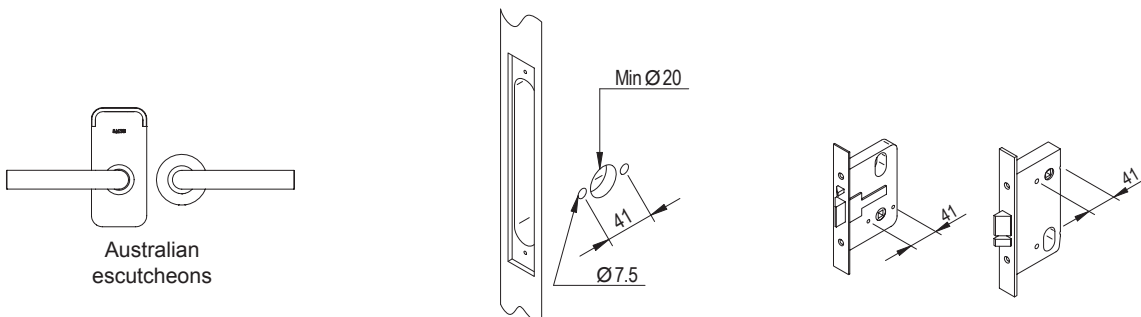

ID technology

RFID

- 9 = Contactless Mifare /DESFire
- B = Contactless BLE Mifare /DESFire
- J = Contactless BLE HID iCLASS



MIFARE
DESFire



Escutcheon

width:
1 = XS4 Mini

Function:

- 50 = Outside reader
- 60 = Outside reader + cover plate
- 70 = Outside reader + cover plate / Inner long plate

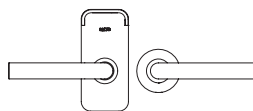

Outside reader

Handles

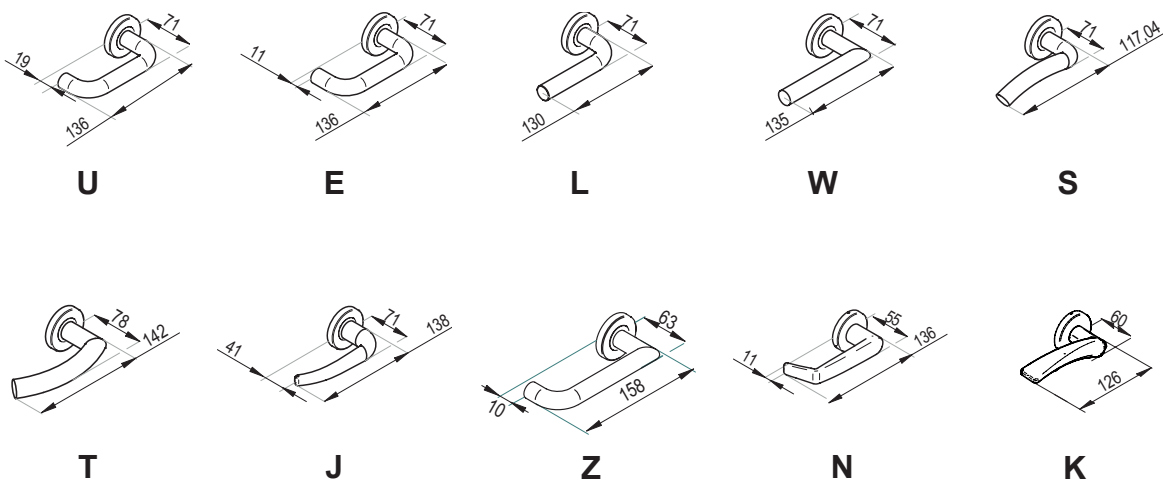

Inside configuration rose:

R = Handle on rose included

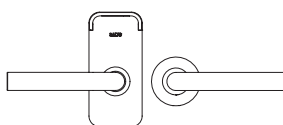

Inside rose included

Handle finishes

- IM = Satin stainless steel
- IP = Bright stainless steel
- PP = Bright Brass
- PM = Satin Brass

- IA = Antique Brass
- NE = Black
- BC = BioCote - antimicrobial finish



Satin stainless steel



Bright stainless steel



Bright Brass PVD



Satin Brass PVD



Antique Brass



Black



BioCote finish



The BioCote and IA finish is 'painted' and sharp objects such as rings and other metallic objects as well as harsh and abrasive chemicals should be avoided during any cleaning process.

Reader Colour:

B = Black reader cover
W = White reader cover



Black reader cover



White reader cover

Door thickness

Through spindle:

- 3** = 35 - 50mm.
- 4** = 47 - 60mm.
- 5** = 57 - 70mm.
- 6** = 67 - 80mm.
- 7** = 77 - 90mm.

Split spindle:

□7.6mm SPLIT SPINDLE AUSTRALIA*		
t	F	Door thickness
2	14.5mm	32.50 - 50 mm
A	17mm	
B	19.5mm	
5	22mm	
9	16-58.5mm	47 - 70 mm
1		67 - 90 mm

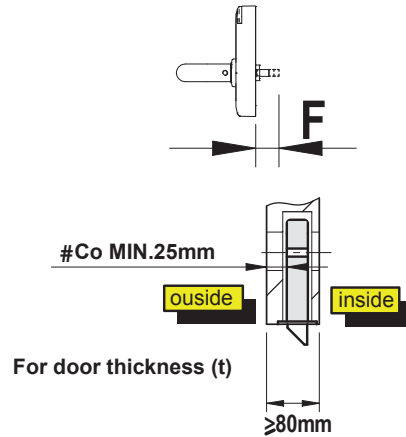

Square spindle

- 8** = 8 mm.
- 6** = 7.6mm SPLIT.

Handle handing

R = Right hand.
L = Left hand.
 for handed handles and models Sx170

R	RIGHT HAND
L	LEFT HAND

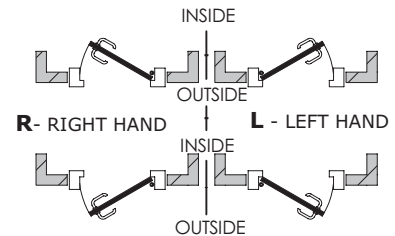

Model Ux150	SALTO XS4 Mini Escutcheon Ux150, for Australian mortise locks 2 Handles, any type
--------------------	--

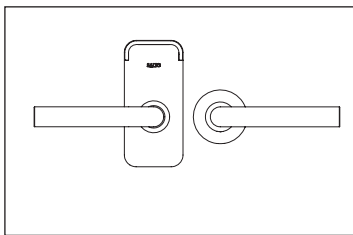

Mifare DESFire BLE
Mifare DESFire
HID iCLASS BLE

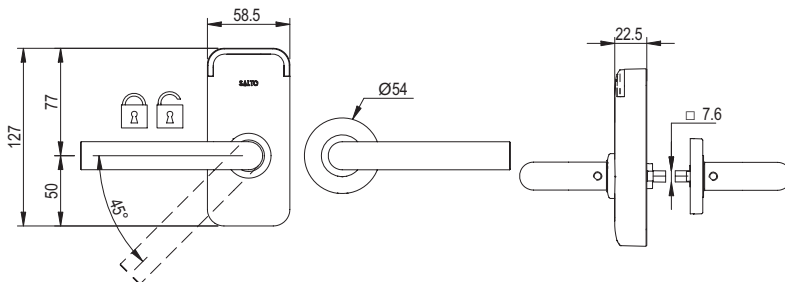

Prices - Gross prices	€
MIFARE DESFire BLE Mifare DESFire: Standard - standard square spindles, finishes and handles.	387,95
MIFARE DESFire Mifare DESFire: Standard - standard square spindles, finishes and handles.	360,25
BLE HID iCLASS: Standard - standard square spindles, finishes and handles.	496,60

Technology	Escutcheon width	Function	Handle	Inside rose configuration	Handle finish	Reader colour	Door thickness	Square spindle	Handing						
U9 Prox. Mifare DESFire	1	50	U	R	IM	B Black cover	2 32-50mm F=14.5mm	6 7.6mm split	-						
			L		IP ²		A 32-50mm F=17mm		-						
			W		5 32-50mm F=22mm		-								
			S ^{1,2}		9 47-70mm F=16-58.5mm		R/L ¹								
UB Prox. BLE Mifare DESFire			1		50	T	R	PM	W White cover	1 67-90mm F=16-58.5mm	8 8mm	-			
						J		3 35-50mm		-					
						E		4 47-60mm		-					
UJ Prox. BLE HID iCLASS						1		50	Z	R	NE ²	W White cover	5 57-70mm	8 8mm	-
									N ¹		6 67-80mm		-		
									K ¹		7 77-90mm		R/L ¹		
									BC ² BioCote						



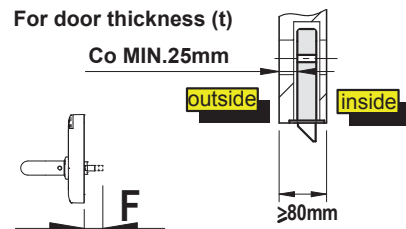
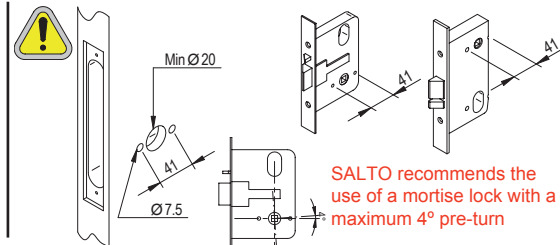

¹ For Handed lever handles, only for K and S handles.

² This option has an additional price please refer to the handles or finishes chapter.





Product description	Product reference	€
---------------------	-------------------	---

Stainless steel finishes

Satin stainless steel 	E X X X X X X I M X X	0,00
Polished stainless steel 	E X X X X X X I P X X	15,70

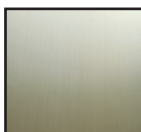
Brass finishes

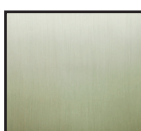
Polished brass Cover plates made of stainless steel with a PVD coating. Handles made of stainless steel with a PVD coating except O handle which is made in brass with PVD coating. 	E X X X X X X P P X X	0,00
Antique brass Cover plates made of stainless steel with a special finish simulating antique brass. 	E X X X X X X I A X X	0,00
Satin brass Cover plates made of stainless steel with a PVD coating. Handles made of stainless steel with a PVD coating except O handle which is made in brass with PVD coating. 	E X X X X X X P M X X	0,00

RAL colours

Black 	E X X X X X X N E X X	24,90
--	-----------------------	-------

BioCote antimicrobial finishe









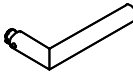

SALTO BioCote finish Cover plates made of stainless steel with a Biocote antimicrobial coating. 	E X X X X X X B C X X	40,80
--	-----------------------	-------

Example of price calculation for finishes other than Satin Stainless (IM), which is the standard used in our price list.

Required is E9150URNEB38 escutcheon.	€
E9150URIMB38	360,25
Additional price for Black finish	24,90
Total Price:	385,15

Only those handles regarded as off-set handles have an add-on to the price of the standard escutcheon. 2 remarks:

- Prices are gross and per handle, so an E9150 model, for instance, needs 2 handles in the case of an off-set model.
- Prices refer to the IM finish, so please refer to the finishes pricelist in order to establish final price of the product.

Finish Model		PVD							Spindle available		Gross price €	
		Satin stainless steel	Polished stainless steel	Polished brass colour	Satin brass colour	Antique brass colour	Black	BioCote	8 <input type="checkbox"/>	7,6 <input type="checkbox"/>		
		IM	IP	PP	PM	IA	NE	BC				
	U	✓	✓	✓	✓	✓	✓	✓	✓	✓	0,00	
	L	✓	✓	✓	✓	✓	✓	✓	✓	✓	0,00	
	W	✓	✓	✓	✓	✓	✓	✓	✓	✓	0,00	
	E	✓	✓	✓	✓	✓	✓	✓	✓	✓	0,00	
	S	✓						✓	✓	✗	✗	30,15
	T	✓			✓			✓	✓	✓	0,00	
	J	✓			✓	✓	✓	✓	✓	✓	0,00	
	G	✓			✓			✓	✓	✓	30,15	
	N	✓			✓			✓	✓	✓	0,00	
	Z	✓			✓			✓	✓	✓	0,00	
	K	✓	✓	✓							0,00	



SALTO escutcheon reference example

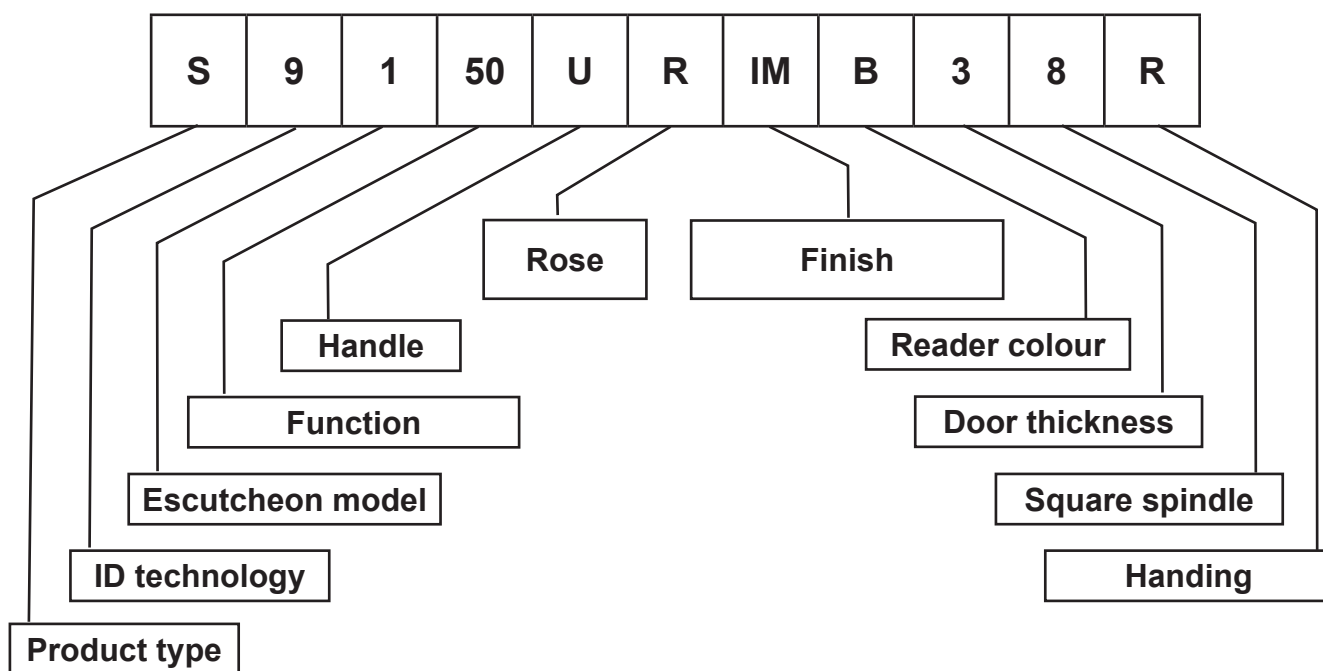

Product type:

S = Escutcheon Compatible with Scandinavian modular mortise locks

Scandinavian escutcheons

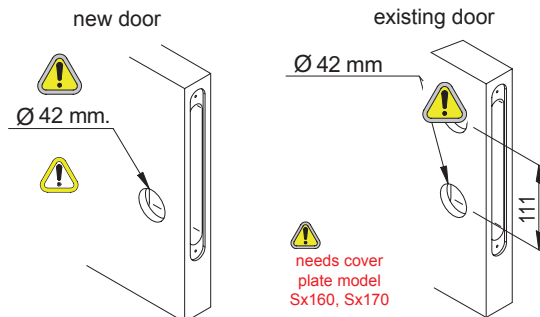
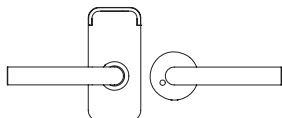

ID technology

RFID

- 9 = Contactless Mifare /DESFire
- B = Contactless BLE Mifare /DESFire
- J = Contactless BLE HID iCLASS



MIFARE
DESFire



Escutcheon

width:

1 = XS4 Mini

Function:

- 50 = Outside reader
- 60 = Outside reader + cover plate
- 70 = Outside reader + cover plate / Inner long plate

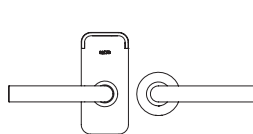

Outside reader

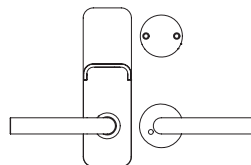

Outside reader + cover plate

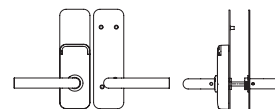

Outside reader + cover plate / Inner long plate

Handles

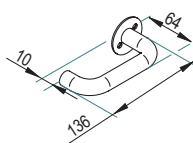

U

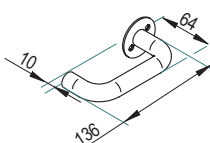

E

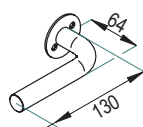

L

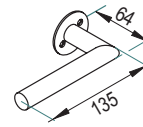

W

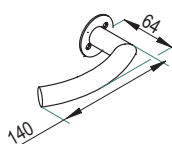

T

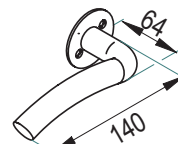

S

Inside configuration rose:

R = Handle on rose included

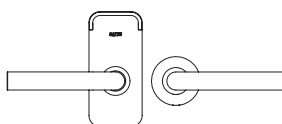

Inside rose included

Handle finishes

- IM = Satin stainless steel
- PM = Satin Brass
- BC = BioCote - antimicrobial finish



Satin stainless steel



Satin Brass PVD



BioCote finish



The BioCote and IA finish is 'painted' and sharp objects such as rings and other metallic objects as well as harsh and abrasive chemicals should be avoided during any cleaning process.

Reader Colour:

- B = Black reader cover
- W = White reader cover



Black reader cover



White reader cover

Door thickness

- For Models:**
- 3** = 35 - 50mm.
 - 4** = 47 - 60mm.
 - 5** = 57 - 70mm.
 - 6** = 67 - 80mm.
 - 7** = 77 - 90mm.
 - 9** = 87-100mm.
- Sx1**

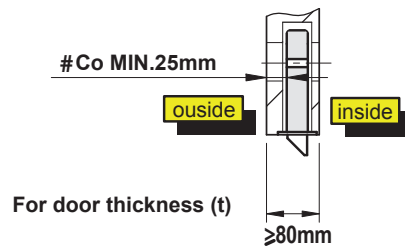

Square spindle

8 = 8 mm.

Handle handing

R = Right hand.
L = Left hand.

for handed handles and models Sx170

R	RIGHT HAND
L	LEFT HAND

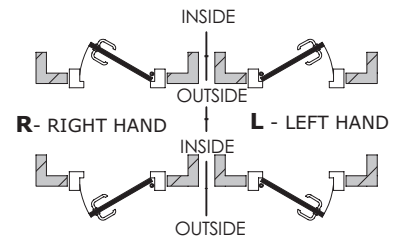

Model Sx150	SALTO XS4 Mini Escutcheon Sx150, for Scandinavian mortise locks 2 Handles, any type
--------------------	--

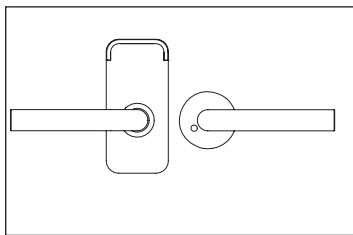

Mifare DESFire BLE
Mifare DESFire
HID iCLASS BLE

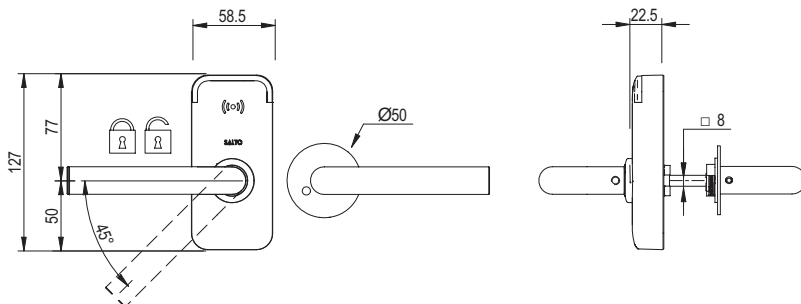

Prices - Gross prices	€
MIFARE DESFire BLE Mifare DESFire: Standard - standard square spindles, finishes and handles.	387,95
MIFARE DESFire Mifare DESFire: Standard - standard square spindles, finishes and handles.	360,25
iCLASS BLE HID iCLASS: Standard - standard square spindles, finishes and handles.	496,60

Technology	Escutcheon width	Function	Handle	Inside rose configuration	Handle finish	Reader colour	Door thickness	Square spindle	Handing
S9 Prox. Mifare DESFire	1	50	U	R	IM	B Black cover	3 35-50mm	8 8mm	-
			L				4 47-60mm		-
SB Prox. BLE Mifare DESFire			W		PM ²	W White cover	5 57-70mm		-
			S ^{1,2}				6 67-80mm		R/L ¹
SJ Prox. BLE HID iCLASS			T		BC ² BioCote	W White cover	7 77-90mm		-
			E				9 87-100mm		-



¹ For Handed lever handles, only for S handles.

² This option has an additional price please refer to the handles or finishes chapter.

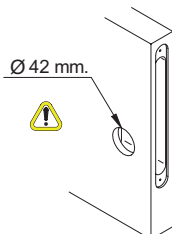

SALTO recommends the use of a mortise lock with a maximum 4° pre-turn

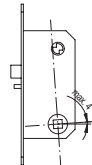

SALTO recommends to use this model in combination with SALTO LS5N04 modular mortise lock series.

Model Sx151

SALTO XS4 Mini Escutcheon Sx151, for Scandinavian mortise locks
2 Handles, any type and inside thumbturn.
Includes turn spindle set

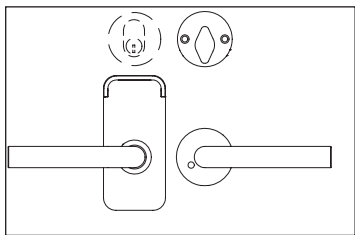

Mifare DESFire BLE
Mifare DESFire
HID iCLASS BLE

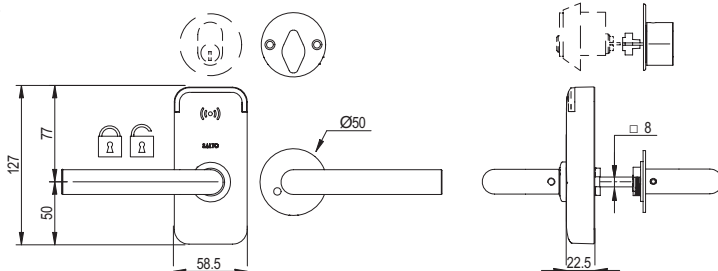

Prices - Gross prices	€
MIFARE DESFire BLE Mifare DESFire: Standard - standard square spindles, finishes and handles.	443,35
MIFARE DESFire Mifare DESFire: Standard - standard square spindles, finishes and handles.	415,65
BLE HID iCLASS: Standard - standard square spindles, finishes and handles.	567,45

Technology	Escutcheon width	Function	Handle	Inside rose configuration	Handle finish	Reader colour	Door thickness	Square spindle	Handing
S9 Prox. Mifare DESFire	1	51	U	R	IM	B Black cover	3 35-50mm	8 8mm	-
			L				4 47-60mm		-
SB Prox. BLE Mifare DESFire			W		PM ²	W White cover	5 57-70mm		-
			S ^{1,2}				6 67-80mm		R/L ¹
SJ Prox. BLE HID iCLASS			T		BC ² BioCote	W White cover	7 77-90mm		-
			E				9 87-100mm		-

Includes turn spindle set
Does not include outside cylinder protector.

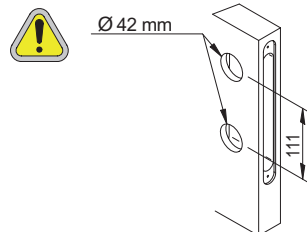

SALTO recommends the use of a mortise lock with a maximum 4° pre-turn

SALTO recommends to use this model in combination with SALTO LS5N15 modular mortise lock series.

¹ For Handed lever handles, only for S handles.

² This option has an additional price please refer to the handles or finishes chapter.

Model Sx154

SALTO XS4 Mini Escutcheon Sx154, for Scandinavian mortise locks
 2 Handles, any type, inside plate.
 For mechanical emergency override

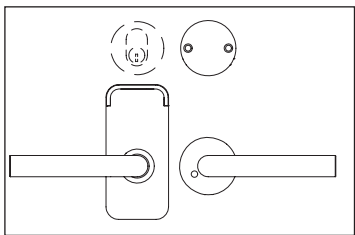

Mifare DESFire BLE
 Mifare DESFire
 HID iCLASS BLE

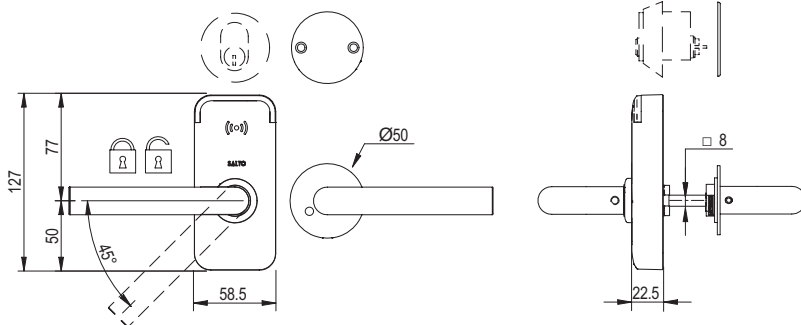

Prices - Gross prices	€
MIFARE DESFire BLE Mifare DESFire: Standard - standard square spindles, finishes and handles.	404,55
MIFARE DESFire Mifare DESFire: Standard - standard square spindles, finishes and handles.	376,85
iCLASS HID BLE HID iCLASS: Standard - standard square spindles, finishes and handles.	517,85

Technology	Escutcheon width	Function	Handle	Inside rose configuration	Handle finish	Reader colour	Door thickness	Square spindle	Handing
S9 Prox. Mifare DESFire	1	54	U	R	IM	B Black cover	3 35-50mm	8 8mm	-
			L				4 47-60mm		-
SB Prox. BLE Mifare DESFire			W		PM ²	W White cover	5 57-70mm		-
			S ^{1,2}				6 67-80mm		R/L ¹
SJ Prox. BLE HID iCLASS			T		BC ² BioCote	W White cover	7 77-90mm		-
			E				9 87-100mm		-



Does not include outside cylinder protector.

¹ For Handed lever handles, only for S handles.

² This option has an additional price please refer to the handles or finishes chapter.

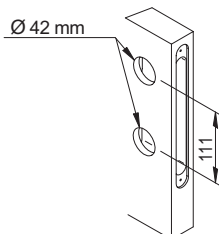

SALTO recommends the use of a mortise lock with a maximum 4° pre-turn

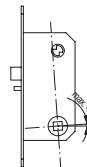

SALTO recommends to use this model in combination with SALTO LS5N05 modular mortise lock series.

Model Sx160

SALTO XS4 Mini Escutcheon Sx160, for Scandinavian mortise locks 2 Handles, any type, outside built in cover plate and inside plate.

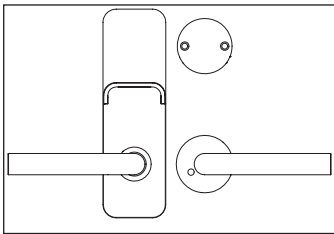

Mifare DESFire BLE
Mifare DESFire
HID iCLASS BLE

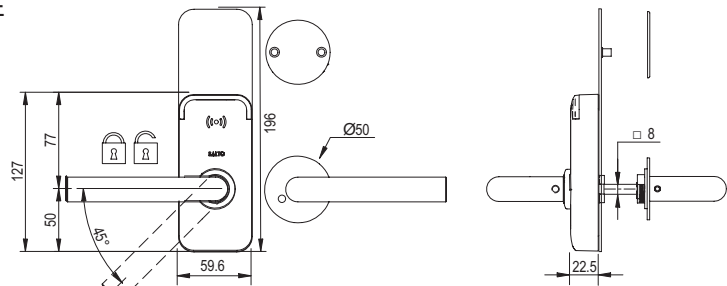

Prices - Gross prices



BLE Mifare DESFire: Standard - standard square spindles, finishes and handles.

€ **448,90**



Mifare DESFire: Standard - standard square spindles, finishes and handles.

€ **421,15**



BLE HID iCLASS: Standard - standard square spindles, finishes and handles.

€ **574,60**

Technology	Escutcheon width	Function	Handle	Inside rose configuration	Handle finish	Reader colour	Door thickness	Square spindle	Handing		
S9 Prox. Mifare DESFire	1	60	U	R	IM	B Black cover	3 35-50mm	8 8mm	-		
			L				4 47-60mm		-		
SB Prox. BLE Mifare DESFire			W				PM ²		W White cover	5 57-70mm	-
			S ^{1,2}							6 67-80mm	R/L ¹
SJ Prox. BLE HID iCLASS			T		BC ² BioCote	W White cover	7 77-90mm		-		
			E				9 87-100mm		-		



¹ For Handed lever handles, only for S handles.

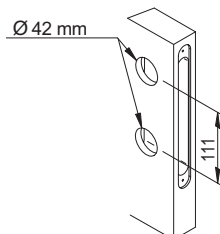

² This option has an additional price please refer to the handles or finishes chapter.



SALTO recommends the use of a mortise lock with a maximum 4° pre-turn

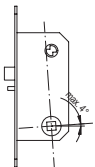

SALTO recommends to use this model in combination with SALTO LS5N04 modular mortise lock series.

Model Sx161

SALTO XS4 Mini Escutcheon Sx161, for Scandinavian mortise locks
2 Handles, any type, outside built in cover plate and inside thumbturn.
Includes turn spindle set

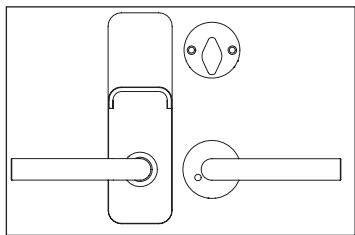

Mifare DESFire BLE
Mifare DESFire
HID iCLASS BLE

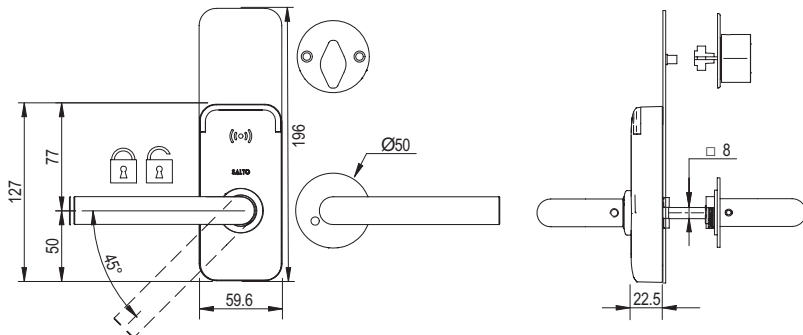

Prices - Gross prices	€
MIFARE DESFire BLE Mifare DESFire: Standard - standard square spindles, finishes and handles.	515,45
MIFARE DESFire Mifare DESFire: Standard - standard square spindles, finishes and handles.	487,70
BLE HID iCLASS: Standard - standard square spindles, finishes and handles.	659,75

Technology	Escutcheon width	Function	Handle	Inside rose configuration	Handle finish	Reader colour	Door thickness	Square spindle	Handing
S9 Prox. Mifare DESFire	1	61	U	R	IM	B Black cover	3 35-50mm	8 8mm	-
			L				4 47-60mm		-
SB Prox. BLE Mifare DESFire			W		PM ²	W White cover	5 57-70mm		-
			S ^{1,2}				6 67-80mm		R/L ¹
SJ Prox. BLE HID iCLASS			T		BC ² BioCote	W White cover	7 77-90mm		-
			E				9 87-100mm		-



Includes turn spindle set

¹ For Handed lever handles, only for S handles.

² This option has an additional price please refer to the handles or finishes chapter.

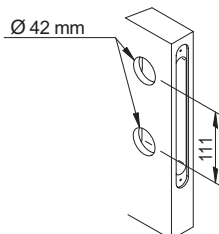

SALTO recommends the use of a mortise lock with a maximum 4° pre-turn

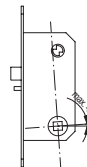

SALTO recommends to use this model in combination with SALTO LS5N15 modular mortise lock series.

Model Sx170

SALTO XS4 Mini Escutcheon Sx170, for Scandinavian mortise locks 2 Handles, any type, outside and inside built in cover plate.

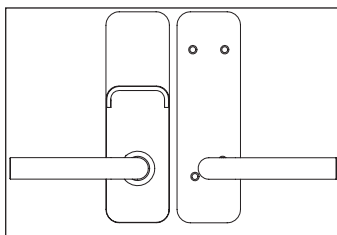

Mifare DESFire BLE
Mifare DESFire
HID iCLASS BLE

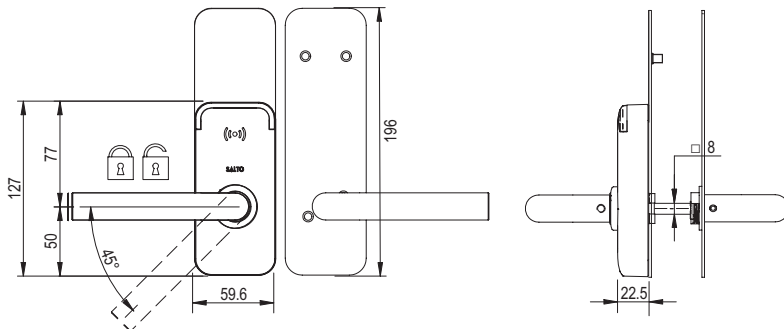

Prices - Gross prices

		€
	BLE Mifare DESFire: Standard - standard square spindles, finishes and handles.	471,05
	Mifare DESFire: Standard - standard square spindles, finishes and handles.	443,35
	BLE HID iCLASS: Standard - standard square spindles, finishes and handles.	602,95

Technology	Escutcheon width	Function	Handle	Inside rose configuration	Handle finish	Reader colour	Door thickness	Square spindle	Handing
S9 Prox. Mifare DESFire	1	70	U	R	IM	B Black cover	3 35-50mm	8 8mm	R/L ¹
			L				4 47-60mm		
SB Prox. BLE Mifare DESFire			W		PM ²	W White cover	5 57-70mm		
			S ^{1,2}				6 67-80mm		
SJ Prox. BLE HID iCLASS			T		BC ² BioCote	W White cover	7 77-90mm		
			E				9 87-100mm		



¹ Handing must be detailed as the inside cover plate is always handed.

² This option has an additional price please refer to the handles or finishes chapter.

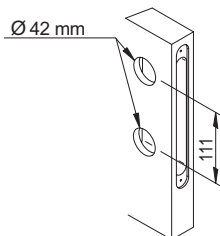

SALTO recommends the use of a mortise lock with a maximum 4° pre-turn

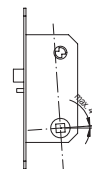

SALTO recommends to use this model in combination with SALTO LS5N04 modular mortise lock series.

Model Sx171

SALTO XS4 Mini Escutcheon Sx170, for Scandinavian mortise locks 2 Handles, any type, outside and inside built in cover plate and inside thumbturn. Includes turn spindle set

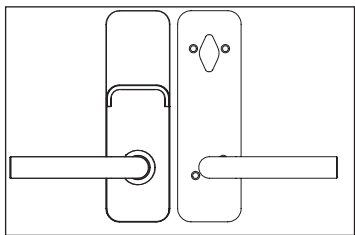

Mifare DESFire BLE
Mifare DESFire
HID iCLASS BLE

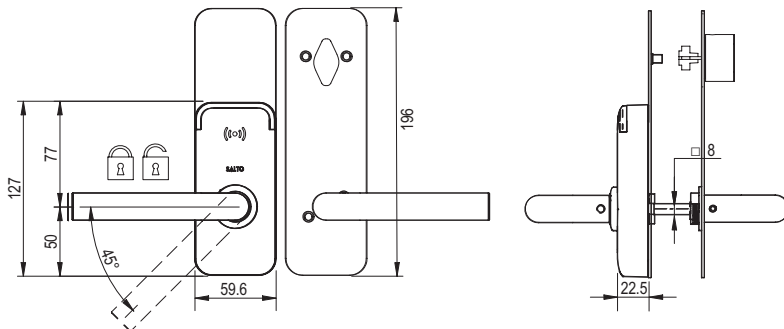

Prices - Gross prices	€
MIFARE DESFire BLE Mifare DESFire: Standard - standard square spindles, finishes and handles.	515,45
MIFARE DESFire Mifare DESFire: Standard - standard square spindles, finishes and handles.	487,70
BLE HID iCLASS: Standard - standard square spindles, finishes and handles.	659,75

Technology	Escutcheon width	Function	Handle	Inside rose configuration	Handle finish	Reader colour	Door thickness	Square spindle	Handing
S9 Prox. Mifare DESFire	1	71	U	R	IM	B Black cover	3 35-50mm	8 8mm	R/L ¹
			L				4 47-60mm		
W			5 57-70mm						
SB Prox. BLE Mifare DESFire			S ^{1,2}		PM ²	W White cover	6 67-80mm		
			T				7 77-90mm		
SJ Prox. BLE HID iCLASS			E		BC ² BioCote	W White cover	9 87-100mm		

Includes turn spindle set

¹ Handing must be detailed as the inside cover plate is always handed.

² This option has an additional price please refer to the handles or finishes chapter.

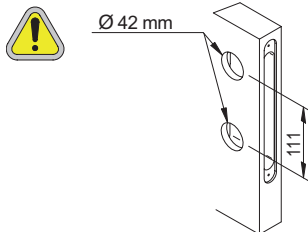

SALTO recommends the use of a mortise lock with a maximum 4° pre-turn

SALTO recommends to use this model in combination with SALTO LS5N15 modular mortise lock series.

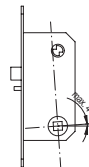

Product description	Product reference	€
---------------------	-------------------	---

Stainless steel finishes

<p>Satin stainless steel</p> 	<p>E X X X X X X I M X X</p>	<p>0,00</p>
---	------------------------------	-------------

Brass finishes

<p>Satin brass Cover plates made of stainless steel with a PVD coating. Handles made of stainless steel with a PVD coating except O handle which is made in brass with PVD coating.</p> 	<p>E X X X X X X P M X X</p>	<p>0,00</p>
---	------------------------------	-------------

BioCote antimicrobial finishe







<p>SALTO BioCote finish Cover plates made of stainless steel with a Biocote antimicrobial coating.</p> 	<p>E X X X X X X B C X X</p>	<p>40,80</p>
--	------------------------------	--------------

Example of price calculation for finishes other than Satin Stainless (IM), which is the standard used in our price list.

Required is E9150URNEB38 escutcheon.	€
E9150URIMB38	360,25
Additional price for Black finish	24,90
Total Price:	385,15

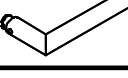
Only those handles regarded as off-set handles have an add-on to the price of the standard escutcheon. 2 remarks:

- Prices are gross and per handle, so an E9150 model, for instance, needs 2 handles in the case of an off-set model.
- Prices refer to the IM finish, so please refer to the finishes pricelist in order to establish final price of the product.

Finish Model		PVD							Spindle available		Gross price €
		Satin stainless steel	Polished stainless steel	Polished brass colour	Satin brass colour	Antique brass colour	Black	BioCote	8 <input type="checkbox"/>	9 <input type="checkbox"/>	
		IM	IP	PP	PM	IA	NE	BC			
	U	↘			↘			↘	↘		0,00
	L	↘			↘			↘	↘		0,00
	W	↘			↘			↘	↘		0,00
	E	↘			↘			↘	↘		0,00
 	S	↘						↘	↘		30,15
	T	↘			↘			↘	↘		0,00

Model SP221457

SALTO XS4 MINI mounting tool

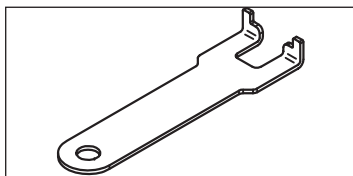

Prices - Gross prices		€
Description	Reference	
SALTO XS4 MINI mounting tool	S P 2 2 1 4 5 7	2,40

Model PPD800

SALTO Portable Programming Device (PPD).

Contactless capabilities for compatibility with XS4 products.

Cable included to connect to the lock. USB connection to the PC.

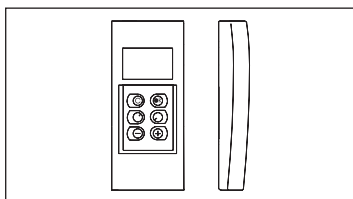

Prices - Gross prices		€
Description	Reference	
SALTO PPD	P P D 8 0 0	526,70



SALTO escutcheon reference example

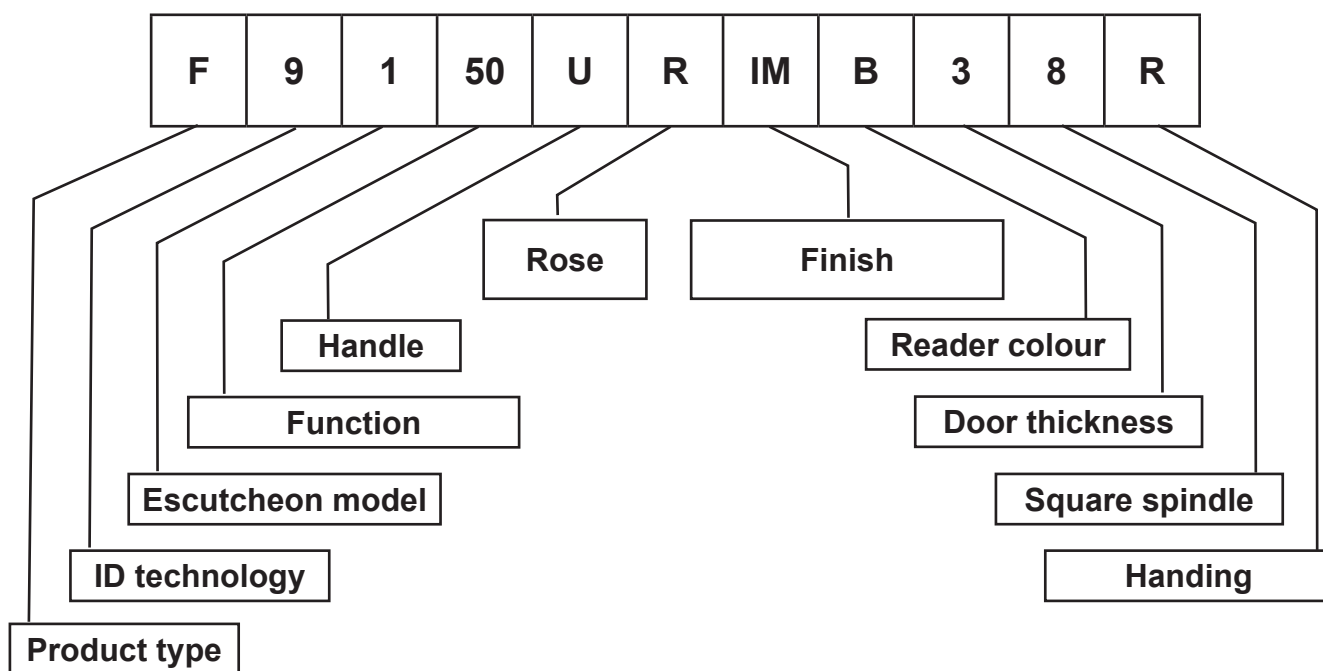

Product type:

F = Escutcheon Compatible with Finnish modular mortise locks

Finnish escutcheons

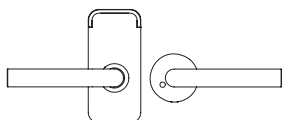

new door

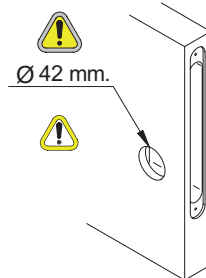

existing door

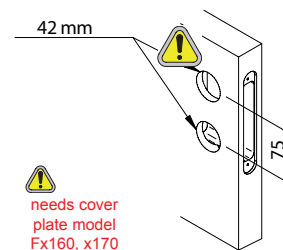

ID technology

RFID

- 9 = Contactless Mifare /DESFire
- B = Contactless BLE Mifare /DESFire
- J = Contactless BLE HID iCLASS



MIFARE
DESFire



Escutcheon

width:

1 = XS4 Mini

Function:

- 50 = Outside reader
- 60 = Outside reader + cover plate
- 70 = Outside reader + cover plate / Inner long plate

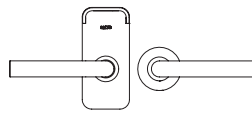

Outside reader

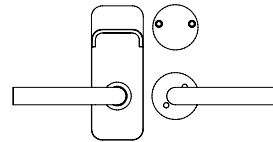

Outside reader + cover plate

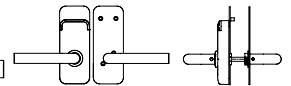

Outside reader + cover plate / Inner long plate

Handles

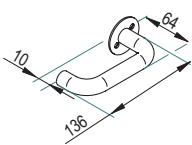

U

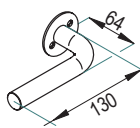

L

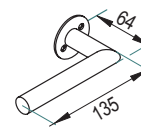

W

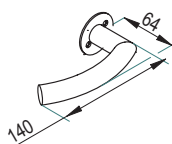

T

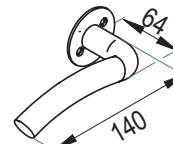

S

Inside configuration rose:

- R = Handle on rose included
- 0 = Not rose included

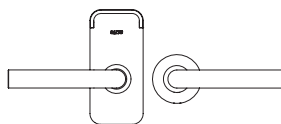

Inside rose included

Handle finishes

- IM = Satin stainless steel
- PM = Satin Brass
- BC = BioCote - antimicrobial finish



Satin stainless steel



Satin Brass PVD

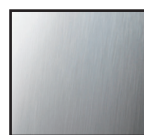

BioCote finish



The BioCote and IA finish is 'painted' and sharp objects such as rings and other metallic objects as well as harsh and abrasive chemicals should be avoided during any cleaning process.

Reader Colour:

- B = Black reader cover
- W = White reader cover



Black reader cover



White reader cover

Door thickness

- 3 = 35 - 50mm.
- 4 = 47 - 60mm.
- 5 = 57 - 70mm.
- 6 = 67 - 80mm.
- 7 = 77 - 90mm.
- 9 = 87-100mm.

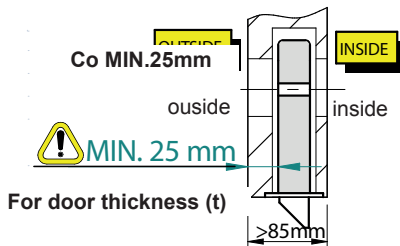

With cover plate door thickness +4mm

Square spindle

8 = 8 mm.

Handle handing

R = Right hand.
L = Left hand.

R	RIGHT HAND
L	LEFT HAND

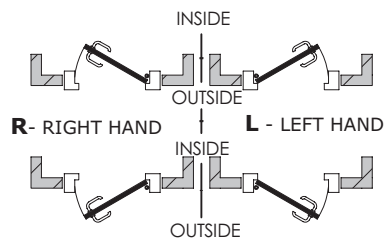

Model Fx150	SALTO XS4 Mini Escutcheon Fx150, for Finnish mortise locks 2 Handles, any type
--------------------	---

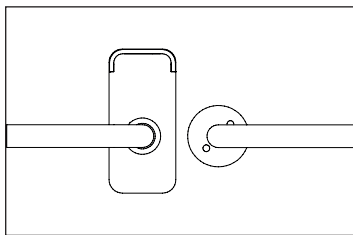

Mifare DESFire BLE
Mifare DESFire
HID iCLASS BLE

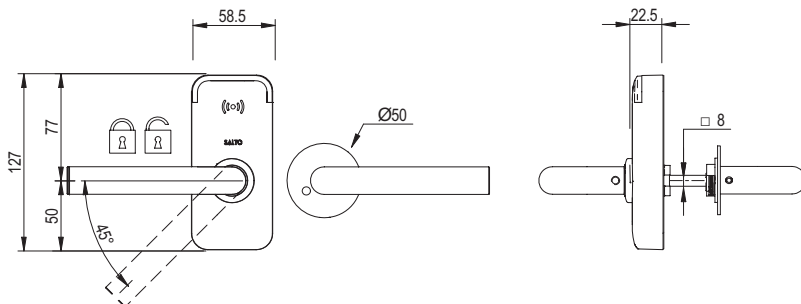

Prices - Gross prices	€
MIFARE DESFire BLE Mifare DESFire: Standard - standard square spindles, finishes and handles.	387,95
MIFARE DESFire Mifare DESFire: Standard - standard square spindles, finishes and handles.	360,25
iCLASS BLE HID iCLASS: Standard - standard square spindles, finishes and handles.	496,60

Technology	Escutcheon width	Function	Handle	Inside rose configuration	Handle finish	Reader colour	Door thickness	Square spindle	Handing
F9 Prox. Mifare DESFire	1	50	U	R	IM	B Black cover	3 35-50mm	8 8mm	-
			L				4 47-60mm		-
FB Prox. BLE Mifare DESFire	1	50	W	R	PM ²	W White cover	5 57-70mm	8 8mm	-
			S ^{1,2}				6 67-80mm		-
FJ Prox. BLE HID iCLASS	1	50	T	R	BC ² BioCote	W White cover	7 77-90mm	8 8mm	R/L ¹
							9 87-100mm		-



¹ For Handed lever handles, only for S handles.

² This option has an additional price please refer to the handles or finishes chapter.

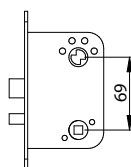
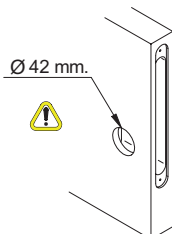

Model Fx151	SALTO XS4 Mini Escutcheon Fx151, for Finnish mortise locks 2 Handles, any type and inside thumbturn. Includes turn spindle set
--------------------	--

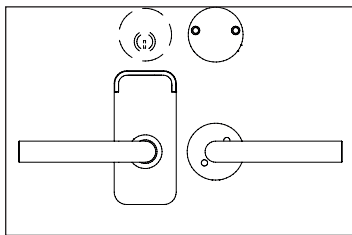

Mifare DESFire BLE
Mifare DESFire
HID iCLASS BLE

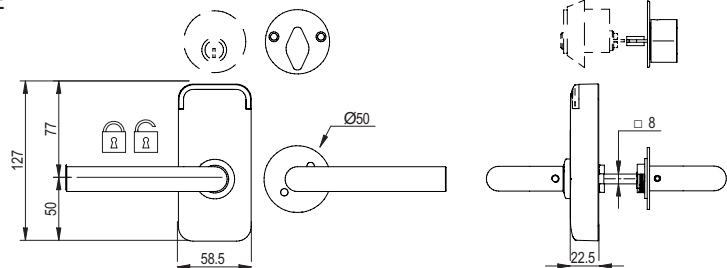

Prices - Gross prices	€
MIFARE DESFire BLE Mifare DESFire: Standard - standard square spindles, finishes and handles.	443,35
MIFARE DESFire Mifare DESFire: Standard - standard square spindles, finishes and handles.	415,65
BLE HID iCLASS: Standard - standard square spindles, finishes and handles.	567,45

Technology	Escutcheon width	Function	Handle	Inside rose configuration	Handle finish	Reader colour	Door thickness	Square spindle	Handing
F9 Prox. Mifare DESFire	1	51	U	R	IM	B Black cover	3 35-50mm	8 8mm	-
			L				4 47-60mm		-
W			5 57-70mm				-		
FB Prox. BLE Mifare DESFire			6 67-80mm		-				
			FJ Prox. BLE HID iCLASS		S ^{1,2}	BC ² BioCote	W White cover		7 77-90mm
T					9 87-100mm				-

Includes turn spindle set
Does not include outside cylinder protector.

¹ For Handed lever handles, only for S handles.

² This option has an additional price please refer to the handles or finishes chapter.

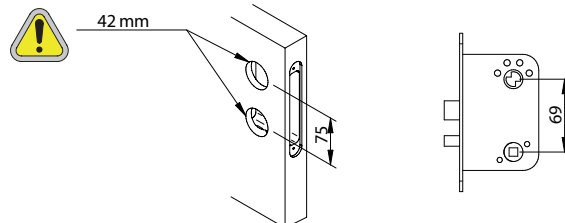

Model Fx154	SALTO XS4 Mini Escutcheon Fx154, for Finnish mortise locks 2 Handles, any type, inside plate. For mechanical emergency override
--------------------	--

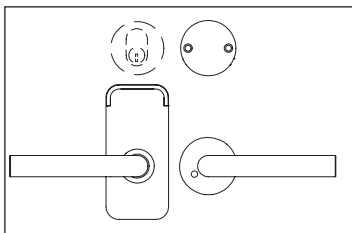

Mifare DESFire BLE
 Mifare DESFire
 HID iCLASS BLE

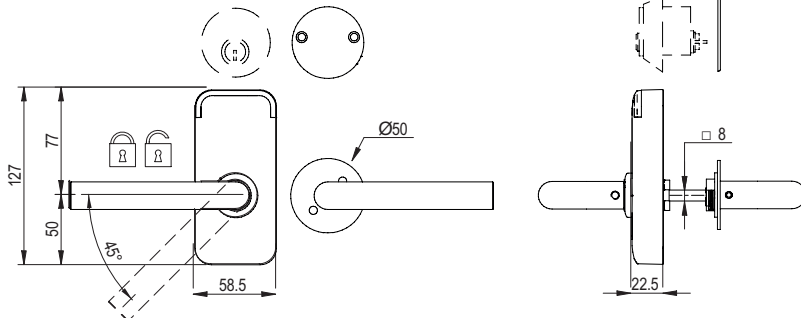

Prices - Gross prices	€
MIFARE DESFire BLE Mifare DESFire: Standard - standard square spindles, finishes and handles.	404,55
MIFARE DESFire Mifare DESFire: Standard - standard square spindles, finishes and handles.	376,85
iCLASS BLE HID iCLASS: Standard - standard square spindles, finishes and handles.	517,85

Technology	Escutcheon width	Function	Handle	Inside rose configuration	Handle finish	Reader colour	Door thickness	Square spindle	Handing
F9 Prox. Mifare DESFire	1	54	U	R	IM	B Black cover	3 35-50mm	8 8mm	-
			L				4 47-60mm		-
FB Prox. BLE Mifare DESFire			W		PM ²	5 57-70mm	-		
			S ^{1,2}			6 67-80mm	-		
FJ Prox. BLE HID iCLASS			W		BC ² BioCote	7 77-90mm	R/L ¹		
			T			9 87-100mm	-		



Does not include outside cylinder protector.

¹ For Handed lever handles, only for S handles.

² This option has an additional price please refer to the handles or finishes chapter.

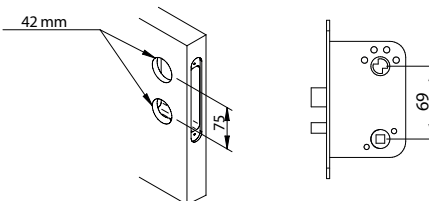

Model Fx160

SALTO XS4 Mini Escutcheon Fx160, for Finnish mortise locks
2 Handles, any type, outside built in cover plate and inside plate.

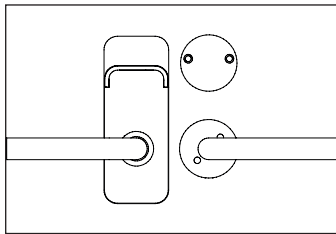

Mifare DESFire BLE
Mifare DESFire
HID iCLASS BLE

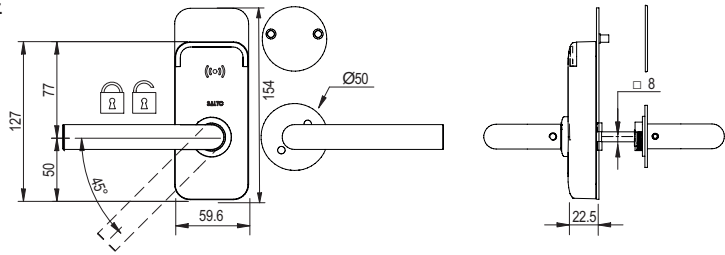

Prices - Gross prices

	€
MIFARE DESFire BLE Mifare DESFire: Standard - standard square spindles, finishes and handles.	448,90
MIFARE DESFire Mifare DESFire: Standard - standard square spindles, finishes and handles.	421,15
iCLASS BLE HID iCLASS: Standard - standard square spindles, finishes and handles.	574,60

Technology	Escutcheon width	Function	Handle	Inside rose configuration	Handle finish	Reader colour	Door thickness	Square spindle	Handing
F9 Prox. Mifare DESFire	1	60	U	R	IM	B Black cover	3 35-50mm	8 8mm	-
			L				4 47-60mm		-
FB Prox. BLE Mifare DESFire			W		PM ²	W White cover	5 57-70mm		-
			S ^{1,2}				6 67-80mm		R/L ¹
FJ Prox. BLE HID iCLASS			T		BC ² BioCote	7 77-90mm	-		
						9 87-100mm	-		



¹ For Handed lever handles, only for S handles.

² This option has an additional price please refer to the handles or finishes chapter.

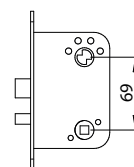
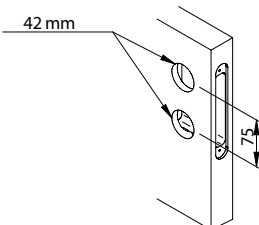

Model Fx161	SALTO XS4 Mini Escutcheon Fx161, for Finnish mortise locks 2 Handles, any type, outside built in cover plate and inside thumbturn. Includes turn spindle set
--------------------	--

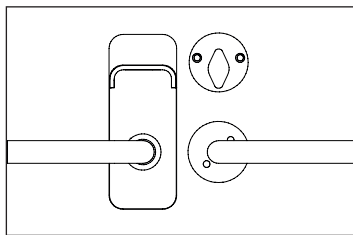

Mifare DESFire BLE
Mifare DESFire
HID iCLASS BLE

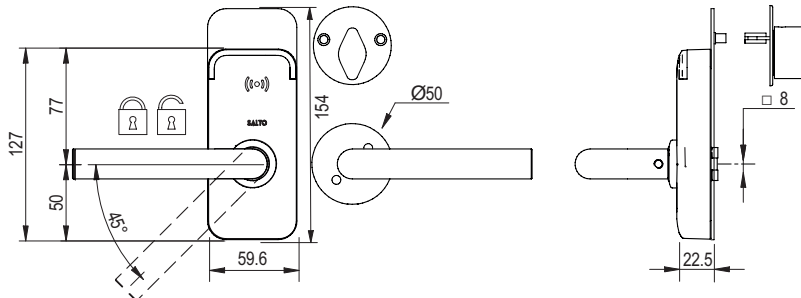

Prices - Gross prices	€
MIFARE DESFire BLE Mifare DESFire: Standard - standard square spindles, finishes and handles.	515,45
MIFARE DESFire Mifare DESFire: Standard - standard square spindles, finishes and handles.	487,70
iCLASS HID BLE HID iCLASS: Standard - standard square spindles, finishes and handles.	659,75

Technology	Escutcheon width	Function	Handle	Inside rose configuration	Handle finish	Reader colour	Door thickness	Square spindle	Handing	
F9 Prox. Mifare DESFire	1	61	U	R	IM	B Black cover	3 35-50mm	8 8mm	-	
			L				4 47-60mm		-	
W			5 57-70mm				-			
FB Prox. BLE Mifare DESFire			S ^{1,2}		6 67-80mm	W White cover	PM ²		6 67-80mm	-
					7 77-90mm				R/L ¹	
FJ Prox. BLE HID iCLASS			T		8 87-100mm	BC ² BioCote	9 87-100mm		-	



Includes turn spindle set

¹ For Handed lever handles, only for S handles.

² This option has an additional price please refer to the handles or finishes chapter.

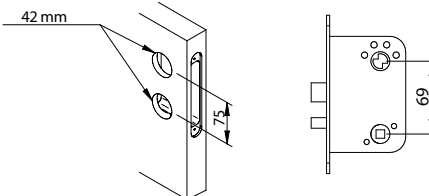

Model Fx170	SALTO XS4 Mini Escutcheon Fx170, for Finnish mortise locks 2 Handles, any type, outside and inside built in cover plate.
--------------------	--

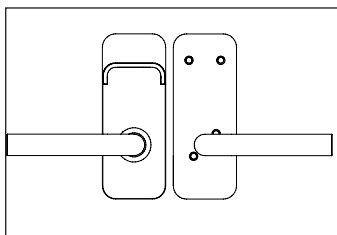

Mifare DESFire BLE
Mifare DESFire
HID iCLASS BLE

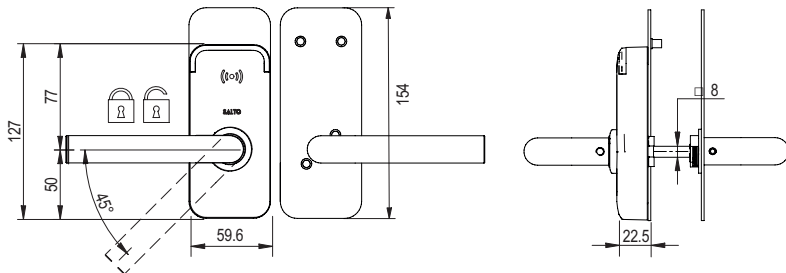

Prices - Gross prices	€
MIFARE DESFire BLE Mifare DESFire: Standard - standard square spindles, finishes and handles.	471,05
MIFARE DESFire Mifare DESFire: Standard - standard square spindles, finishes and handles.	443,35
iCLASS HID BLE HID iCLASS: Standard - standard square spindles, finishes and handles.	602,95

Technology	Escutcheon width	Function	Handle	Inside rose configuration	Handle finish	Reader colour	Door thickness	Square spindle	Handing	
F9 Prox. Mifare DESFire	1	70	U	R	IM	B Black cover	3 35-50mm	8 8mm	-	
			L				4 47-60mm		-	
W			5 57-70mm				-			
FB Prox. BLE Mifare DESFire			S ^{1,2}		6 67-80mm	W White cover	PM ²		6 67-80mm	-
					T				7 77-90mm	R/L ¹
FJ Prox. BLE HID iCLASS			T		9 87-100mm	BC ² BioCote	9 87-100mm		-	

¹ Handing must be detailed as the inside cover plate is always handed.

² This option has an additional price please refer to the handles or finishes chapter.

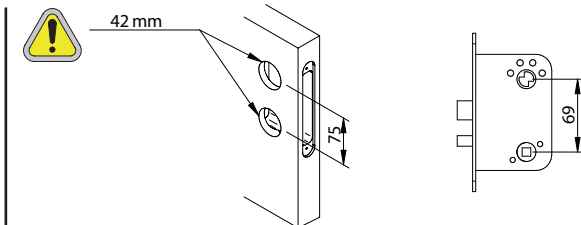

Model Fx171	SALTO XS4 Mini Escutcheon Fx170, for Finnish mortise locks 2 Handles, any type, outside and inside built in cover plate and inside thumbturn. Includes turn spindle set
--------------------	--

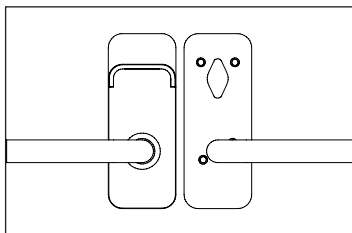

Mifare DESFire BLE
Mifare DESFire
HID iCLASS BLE

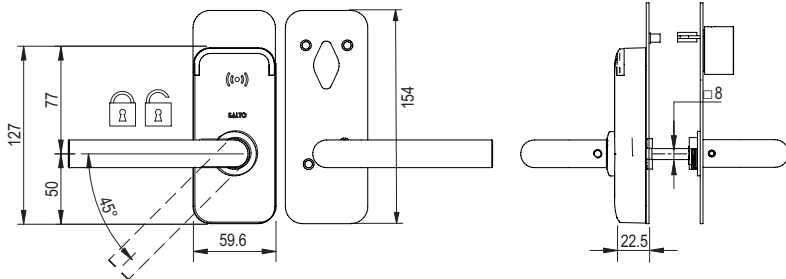

Prices - Gross prices	€
MIFARE DESFire BLE Mifare DESFire: Standard - standard square spindles, finishes and handles.	515,45
MIFARE DESFire Mifare DESFire: Standard - standard square spindles, finishes and handles.	487,70
iCLASS HID BLE HID iCLASS: Standard - standard square spindles, finishes and handles.	659,75

Technology	Escutcheon width	Function	Handle	Inside rose configuration	Handle finish	Reader colour	Door thickness	Square spindle	Handing	
F9 Prox. Mifare DESFire	1	71	U	R	IM	B Black cover	3 35-50mm	8 8mm	-	
			L				4 47-60mm		-	
W			5 57-70mm				-			
FB Prox. BLE Mifare DESFire			S ^{1,2}		6 67-80mm	W White cover	PM ²		6 67-80mm	-
					T				7 77-90mm	R/L ¹
FJ Prox. BLE HID iCLASS			T		9 87-100mm	BC ² BioCote	9 87-100mm		-	

Includes turn spindle set

¹ Handing must be detailed as the inside cover plate is always handed.

² This option has an additional price please refer to the handles or finishes chapter.

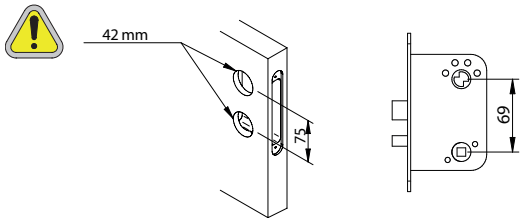

Product description	Product reference	€
---------------------	-------------------	---

Stainless steel finishes

<p>Satin stainless steel</p> 	<p>E X X X X X X I M X X</p>	<p>0,00</p>
---	------------------------------	-------------

Brass finishes

<p>Satin brass Cover plates made of stainless steel with a PVD coating. Handles made of stainless steel with a PVD coating except O handle which is made in brass with PVD coating.</p> 	<p>E X X X X X X P M X X</p>	<p>0,00</p>
---	------------------------------	-------------

BioCote antimicrobial finishe

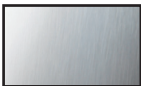



<p>SALTO BioCote finish Cover plates made of stainless steel with a Biocote antimicrobial coating.</p> 	<p>E X X X X X X B C X X</p>	<p>40,80</p>
--	------------------------------	--------------

Example of price calculation for finishes other than Satin Stainless (IM), which is the standard used in our price list.

Required is E9150URNEB38 escutcheon.	€
E9150URIMB38	360,25
Additional price for Black finish	24,90
Total Price:	385,15

Only those handles regarded as off-set handles have an add-on to the price of the standard escutcheon. 2 remarks:

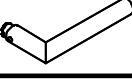
- Prices are gross and per handle, so an E9150 model, for instance, needs 2 handles in the case of an off-set model.
- Prices refer to the IM finish, so please refer to the finishes pricelist in order to establish final price of the product.

Finish Model		PVD							Spindle available		Gross price €
		Satin stainless steel	Polished stainless steel	Polished brass colour	Satin brass colour	Antique brass colour	Black	BioCote	8 <input type="checkbox"/>	9 <input type="checkbox"/>	
		IM	IP	PP	PM	IA	NE	BC			
	U	↘			↘			↘	↘		0,00
	L	↘			↘			↘	↘		0,00
	W	↘			↘			↘	↘		0,00
	S	↘						↘	↘		30,15
	T	↘			↘			↘	↘		0,00



SALTO XS4 Mini

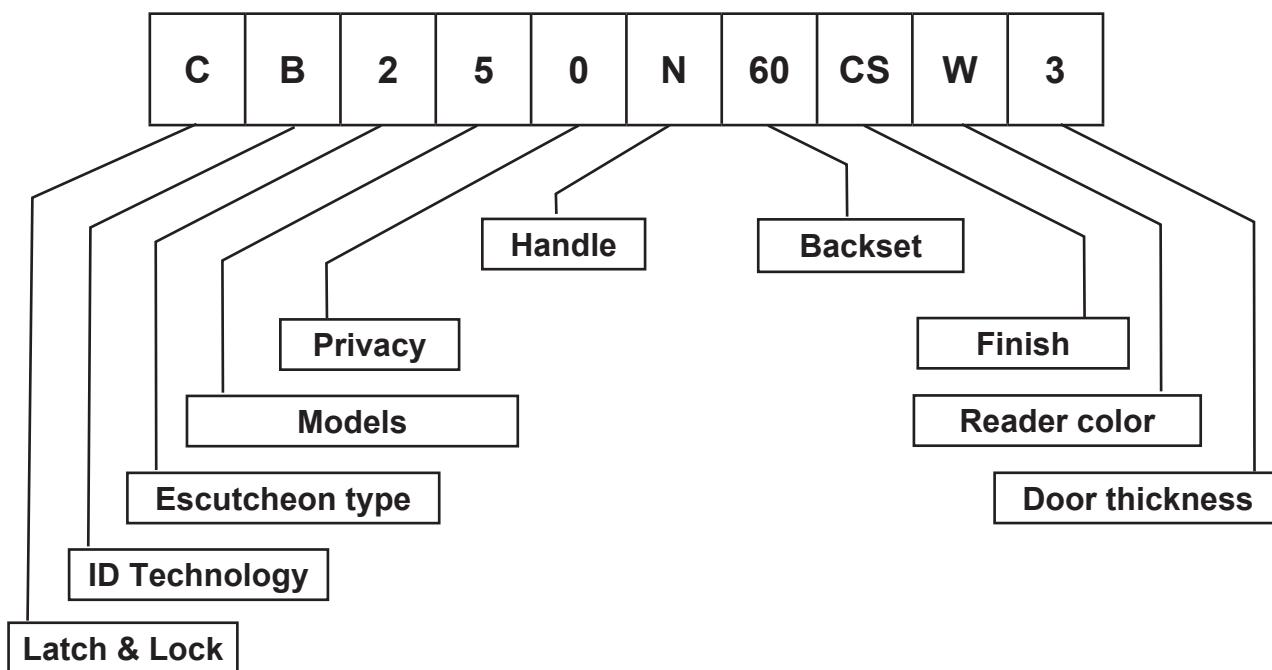

Latch & Lock:

C = Cylindrical Latch.

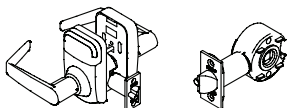

Cylindrical Latch

ID technology

RFID

B = Contactless Mifare / DESFire & BLE
j = Contactless HID iCLASS & BLE

Escutcheon type:

2 = XS4 Mini

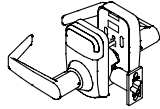

Models:

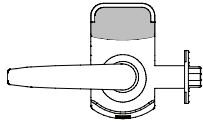

5
Entrance function
Standard model

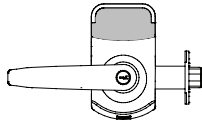

6
Entrance function with
key override
(cylinder not included)



Mechanical cylinder requirements for model with mechanical override

Depending on the cylinder length an adapter (included in the Cx260) may be needed

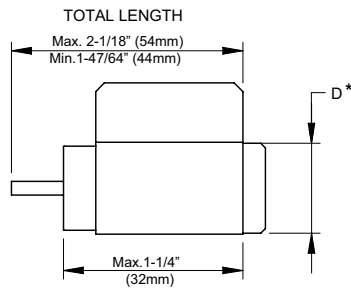
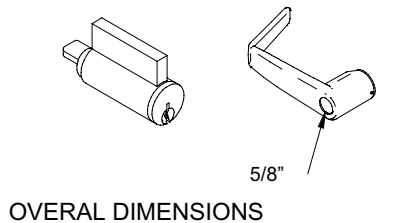

(D) For levers without 5/8" (16mm) hole.
(*) If necessary use a ring

	Cylinder	B (5 pins)	B (5 or 6 pins)
		Less than 1" (55/64" to 63/64") (21,8mm to 25mm).	For 1" (25,4mm).
ADAPTER		(7/8" to 29/32") (22,2mm to 23mm). Standard cylinder 7/8" (22,2mm).	
		(15/16" to 31/32") (23,8mm to 24,6mm). Standard cylinder 61/64" (24,2mm).	
			(1" to 1-1/32") (25,4mm to 26,2mm). Standard cylinder 61/64" (24,2mm).
	WITHOUT		(1-1/16" to 1-3/32") (26,8mm to 27,7mm).

Handles

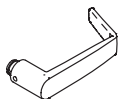

N



R



G

- N is ADA compliant

Backset:

- 60 = 2-3/8" (60 mm)
- 70 = 2-3/4" (70 mm)
- 95 = 3-3/4" (95 mm)
- 27 = 5" (127 mm)

Finishes:

SALTO	BHMA	Fed. Spec	Description
CS	BHMA682	US26D	Satin Chrome
CP	BHMA689	US26	Polished Chrome
IA	BHMA638	US5	Antique Brass
PM	BHMA732	US4	Satin Brass (PVD)
PP	BHMA729	US3	Polished Brass (PVD)
NE	BHMA685		Satin Chrome Black
BC			Biocote

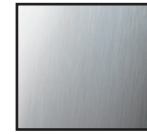

CS



CP

STANDARD



IA



PM



PP



NE



BC



The BioCote and IA finish is 'painted' and sharp objects such as rings and other metallic objects as well as harsh and abrasive chemicals should be avoided during any cleaning process.

Reader color

B = Black
W = White

Door thickness

Cylindrical latch model

- 3 = 40 mm - 47 mm (1 37/64" - 1 3/4") STANDARD
- 4 = 45 mm - 60 mm (1 3/4" - 2 3/8")
- 6 = 60 mm - 75 mm (2 3/8" - 3")
- 7 = 75 mm - 90 mm (3" - 3 1/2")
- 9 = 90 mm - 105 mm (3 1/2" - 4 1/8")

Model Cx250

SALTO XS4 Mini ANSI Electronic Escutcheon
 Grade 1 cylindrical latch, 2 handles, any type. Entrance Lock.

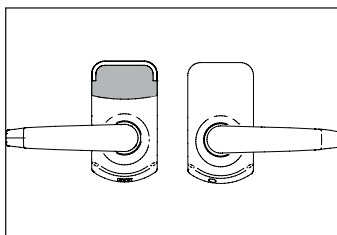

BLE
 Mifare - DESFire
 HID iCLASS

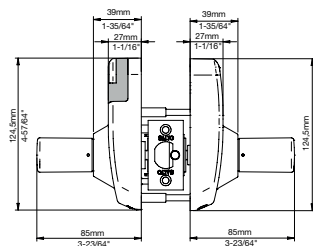
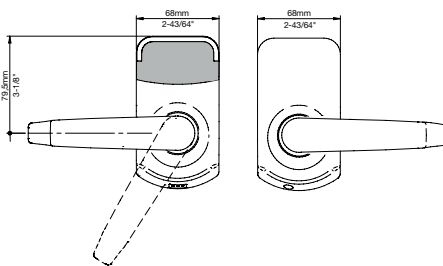

Prices - Gross prices	€
MIFARE DESFire BLE Mifare DESFire: Standard - standard square spindles, finishes and handles.	740,45
iCLASS BLE HID iCLASS: Standard - standard square spindles, finishes and handles.	947,75

Product Technology	Escutcheon type	Models	Models	Backset	Finish	Reader Colour	Door thickness	Square spindle	Handing
CB Prox. BLE Mifare DESFire	2	50	N	60 60mm (2 3/8") STANDARD	CS Satin Chrome	B Black cover	3 40 - 47 mm	8 8mm	- No handing reversible
				70 70mm (2 3/4")	CP ¹ Polished Chrome		4 45 - 60 mm		
			R	95 95mm (3 3/4")	PP ¹ Polished Brass (PVD Finish)		6 60 - 75 mm		
				G	27 127mm (5")		PM ¹ Satin Brass (PVD Finish)		
CJ Prox. BLE HID iCLASS	50	G	27 127mm (5")		NE ¹ Satin Black	W White cover	9 90 - 105 mm	8 8mm	- No handing reversible
				BC ¹ Biocote	9 90 - 105 mm				



Includes cylindrical latch, dustbox, A strike.
 To be used only with SALTO's cylindrical latch.

¹ This option has an additional price please refer to the handles or finishes chapter.

Model Cx260	SALTO XS4 Mini ANSI Electronic Escutcheon Grade 1 cylindrical latch, 2 handles, any type. Entrance Lock with key override. (mechanical cylinder not included)
--------------------	--

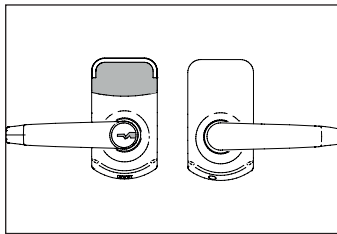

BLE
Mifare - DESFire
HID iCLASS

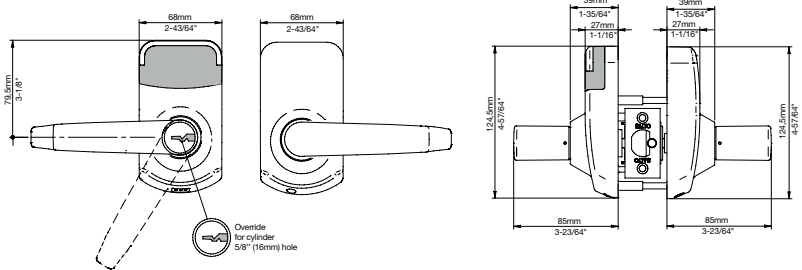

Prices - Gross prices	€
MIFARE DESFire BLE Mifare DESFire: Standard - standard square spindles, finishes and handles.	740,45
iCLASS HID BLE HID iCLASS: Standard - standard square spindles, finishes and handles.	947,75

Product Technology	Escutcheon type	Models	Models	Backset	Finish	Reader Colour	Door thickness	Square spindle	Handing
CB Prox. BLE Mifare DESFire	2	60	N	60 60mm (2 3/8") STANDARD	CS Satin Chrome	B Black cover	3 40 - 47 mm	8 8mm	- No handing reversible
				70 70mm (2 3/4")	CP ¹ Polished Chrome		4 45 - 60 mm		
			R	95 95mm (3 3/4")	PP ¹ Polished Brass (PVD Finish)	6 60 - 75 mm			
				G	27 127mm (5")	PM ¹ Satin Brass (PVD Finish)	7 75 - 90 mm		
CJ Prox. BLE HID iCLASS	60	G	27 127mm (5")		NE ¹ Satin Black	W White cover	9 90 - 105 mm		
				BC ¹ Biocote					



Includes cylindrical latch, dustbox, A strike.
To be used only with SALTO's cylindrical latch.

Mechanical cylinder for the override not included

¹ This option has an additional price please refer to the handles or finishes chapter.

Cylinders compatibility

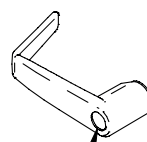
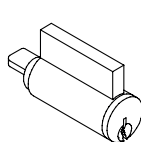

5/8"

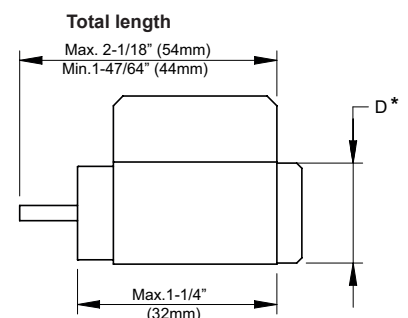

Product description	Product reference	€
---------------------	-------------------	---

Stainless steel finishes

Satin Chromium Black reader	C X X X X X X X CSB X X	0,00
Satin Chromium White reader	C X X X X X X X CSW X X	
Polished Chromium Black reader	C X X X X X X X CPB X X	15,70
Polished Chromium White reader	C X X X X X X X CPW X X	

Brass finishes

PVD Bright brass type Black reader	C X X X X X X X PPB X X	24,90
PVD Bright brass type White reader	C X X X X X X X PPW X X	
PVD Satin brass type Black reader	C X X X X X X X PMB X X	24,90
PVD Satin brass type White reader	C X X X X X X X PMW X X	

BioCoted Satin Chromium	C X X X X X X X BCB X X	40,80
-------------------------	--------------------------------	-------

Black Satin Chromium Black reader	C X X X X X X X NEB X X	24,90
Black Satin Chromium White reader	C X X X X X X X NEW X X	

Example of price calculation for finishes other than Satin Stainless (IM), which is the standard used in our price list.

CB250N50CSB3 is required.	€
CB250N50CSB3	740,45
Additional price for PVD Bright brass type finish	24,90
Total Price:	765,35

Cover Plate
COPLEMA090

SALTO XS4 Mini ANSI cover plate, for CB2x0 range to retrofit doors that were equipped with cartridge cylindrical latch.
Made of steel. The set includes 2 plates (inside and outside)

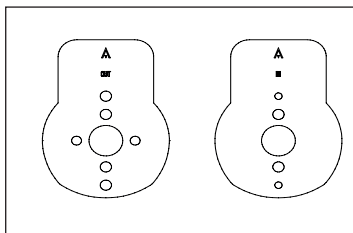

Prices - Gross prices				€
Model	Width	Finish	Special plates	
COPLEMA	090	IM		36,10
COPLEMA	090	IP		48,10
COPLEMA	090	PP		92,10
COPLEMA	090	PM		80,05
COPLEMA	090	NE		81,70
COPLEMA	090	BC		86,60

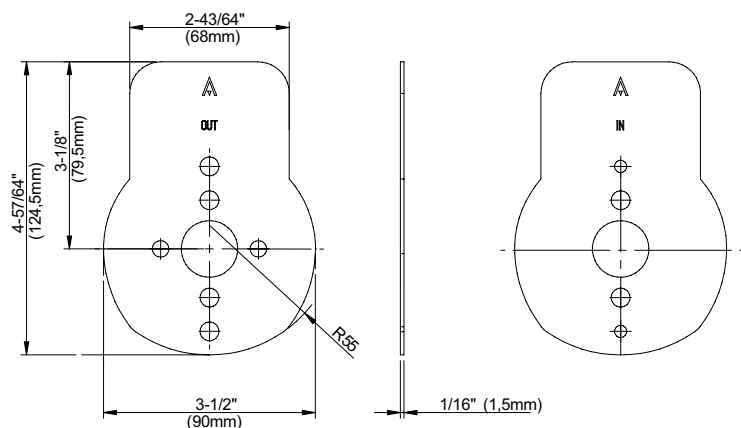

Cover Plate Mini
ANSI custom

SALTO CUSTOM Cover-all Plates for SALTO XS4 Mini ANSI
If you need a special cover plate you can request it by sending back all the info detailed on the chart below, and SALTO will send you the quotation for this customization service.

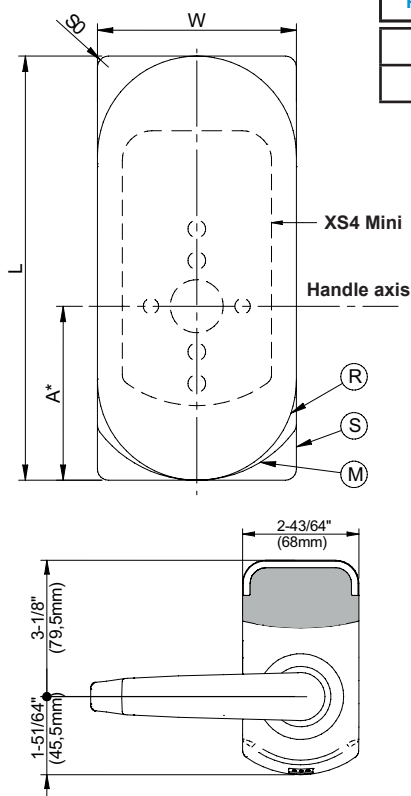

Prices - Gross prices				€
Model	Width	Finish	Special plates	
COPLEM		CUSTOM		Upon request

Dimensions							Quant.	Finish	
S0	TYPE			LENGTH	WIDTH	VERTICAL ALIGNMENT			
	(Min=2mm)	R	S	M	L	W	A* (min 65mm)		

Cover plate type

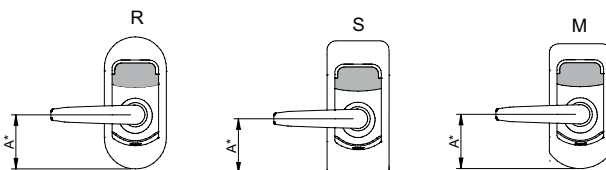

A*: minimum distance recommended 65mm.
S0: recommended measure=13mm.
If vertical alignment is not indicated, we understand that the escutcheon will fit centrally in the plate.

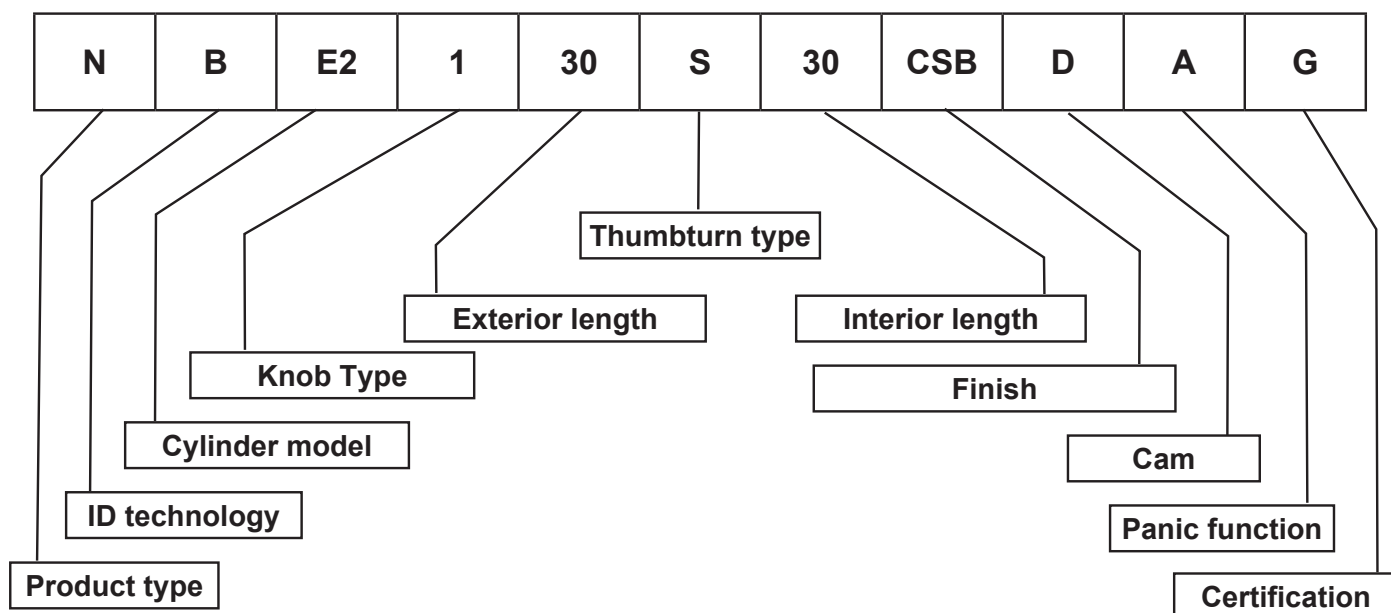

Product type:

N = SALTO NEO Electronic cylinder

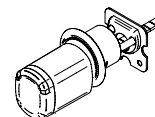
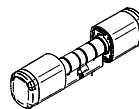
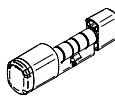

ID technology

RFID

B = BLE DESFire MIFARE

J = BLE HID iCLASS Seos

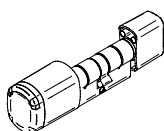

BLE MIFARE DESFire technologies can be set up as RW and SALTO KS as it is BLUE-net wireless ready.

Model

- E1 = Half Euro profile cylinder.
- E2 = Euro profile cylinder with thumbturn.
- E3 = Euro profile double cylinder, double knob.
- E9 = Electronic cylinder for swing handles.
- CL = Cam lock cylinder.
- U1 = Half UK profile cylinder.
- U2 = UK profile cylinder with thumbturn.
- U3 = UK profile double cylinder, double knob.
- S1 = Standard Scandinavian external cylinder.
- S2 = Standard Scandinavian internal cylinder.
- S3 = Scandinavian Security external cylinder.
- K1 = UK profile Rim cylinder.
- B1 = USA profile Rim cylinder.
- B2 = Schlage® B-series with deadbolt Rim cylinder.
- B3 = Heavy duty deadbolt.
- M1 = Mortice USA profile cylinder.
- A1 = Australian oval profile cylinder.
- H1 = Half Swis profile cylinder.
- H2 = Swiss profile cylinder with thumbturn.
- H3 = Swiss profile double cylinder, double knob
- J1 = Japanese round cylinder

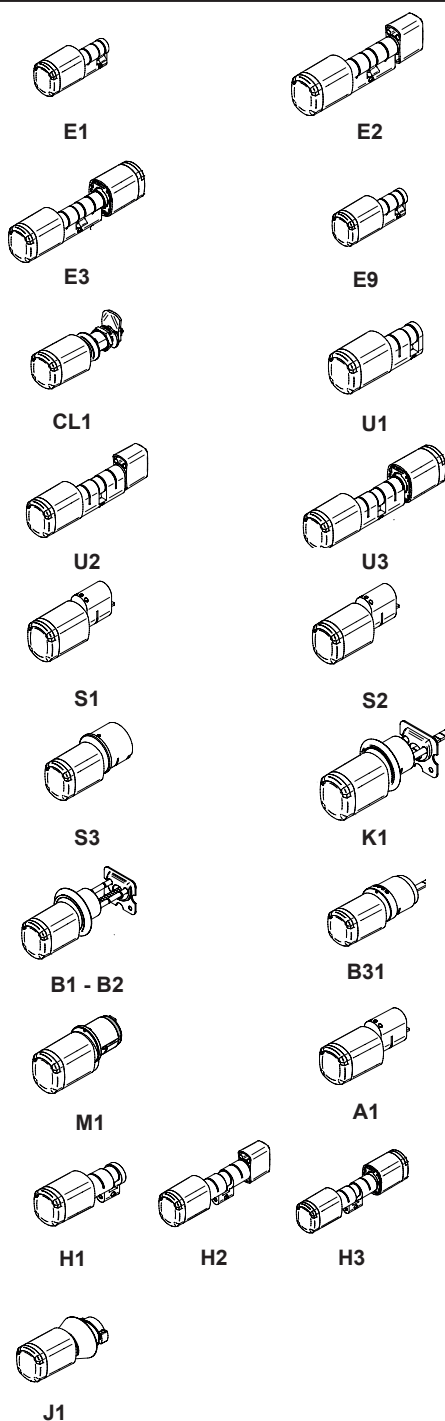

Knob type

1 = Standard removable knob, the battery can be changed .

Knob type 1
removable knob

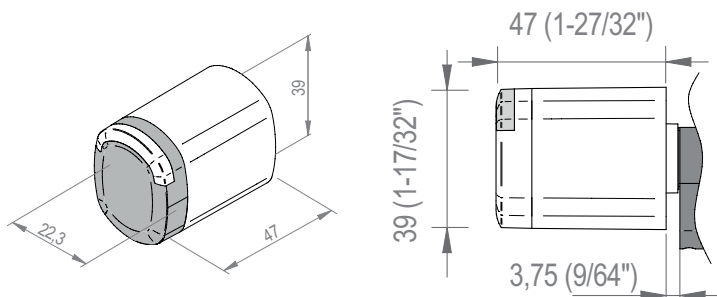

Cylinder length

(le) Outside length
(li) Inside length

le (exterior length)

from 30mm. up to 100mm.

30 = 30mm.	1A = 100mm.
35 = 35mm.	1B = 105mm.
40 = 40mm.	1C = 110mm.
45 = 45mm.	1D = 115mm.
50 = 50mm.	1E = 120mm.
55 = 55mm.	1F = 125mm.
60 = 60mm.	1G = 130mm.
65 = 65mm.	1H = 135mm.
70 = 70mm.	1I = 140mm.
75 = 75mm.	1J = 145mm.
80 = 80mm.	1K = 150mm.
85 = 85mm.	1L = 155mm.
90 = 90mm.	1M = 160mm.
95 = 95mm.	1N = 165mm.

li (interior length)

from 10mm. up to 100mm.

00 = not applicable.
(for half cylinders, Rim cylinders or Mortise cylinders)

10 = 10mm.	90 = 90mm.
15 = 15mm.	95 = 95mm.
20 = 20mm.	1A = 100mm.
25 = 25mm.	1B = 105mm.
30 = 30mm.	1C = 110mm.
35 = 35mm.	1D = 115mm.
40 = 40mm.	1E = 120mm.
45 = 45mm.	1F = 125mm.
50 = 50mm.	1G = 130mm.
55 = 55mm.	1H = 135mm.
60 = 60mm.	1I = 140mm.
65 = 65mm.	1J = 145mm.
70 = 70mm.	1K = 150mm.
75 = 75mm.	1L = 155mm.
80 = 80mm.	1M = 160mm.
85 = 85mm.	1N = 165mm.

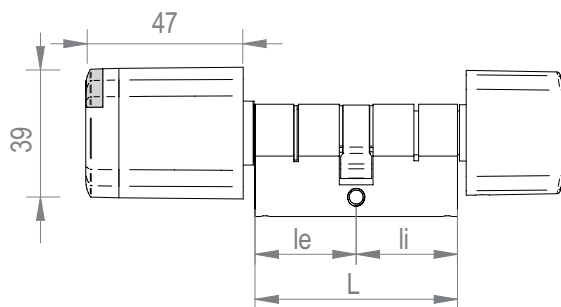

le for mortise (exterior length)

from 32mm. up to 50mm.

32 = 32mm.
35 = 35mm.
38 = 38mm.
41 = 41mm.
44 = 44mm.
50 = 50mm.

* Some distance can have an additional price consult the cylinder section.

Depending on the total length, the cylinder model can change

Thumbturn design

S = Standard.

R = Round.

N = No thumbturn.

(for half cylinders, Rim cylinders or Mortise cylinders)

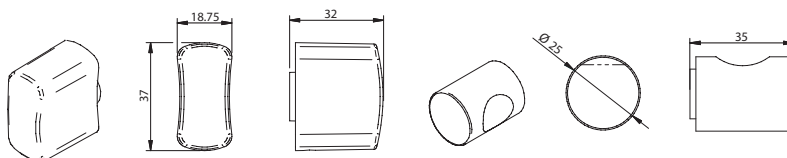

S thumbturn

R thumbturn

Knob finishes

CSB =

Satin Chrome
Black reader



PPB =

Polished bright
brass type (PVD)
Black reader



BCB =

BioCoted
Satin Chrome
Black reader

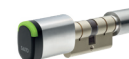

CPB =

Polished Chrome
Black reader



PMB =

Satin brass type
(PVD)
Black reader



NEB =

Satin Chrome
Black
Black reader



CSW =

Satin Chrome
White reader



PPW =

Polished bright
brass type (PVD)
White reader



CPW =

Polished Chrome
White reader



PMW =

Satin brass type
(PVD)
White reader



Please note that brass finishes may become discoloured over time due to their exposure to environmental conditions such as humidity, pollution and salt air. Rings and keys can also scratch the brass lacquer finish and once this has started to occur, discolouration will likely begin.

Cams

- D** = DIN cam for Euro profile (15mm) **standard**.
- K** = UK oval cam 14.3mm.
- M** = DIN cam 13.2 mm for metal doors **(for Spanish metal doors)**.
- N** = Not applicable **(for Rim cylinders or Mortise cylinders)**.
- H** = Swiss 15mm **(for Swiss cylinders)**.
- G** = Cog wheel cam 10 teeth.
- Z** = Cog wheel cam 13 teeth.

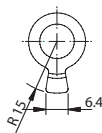

D cam

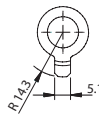

K cam

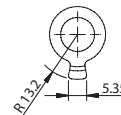

M cam

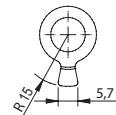

H cam

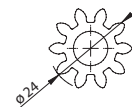

G cam

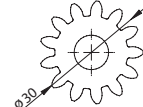

Z cam

Special function

- = No panic function

A = Panic function A
 Panic function a reset the cam to a specific position.

K = Amok function
 Panic function a reset the cam to a specific position.

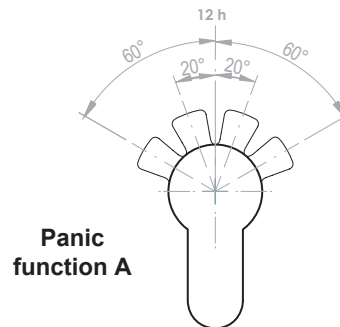

Panic function A

Certification

- = No special certification

G = SKG*** compliant (IP66 as standard)

V = VDS Bz+ compliant (IP66 as standard)
 Not available yet - VDS version will be release at the end of 2020
 VDS certification is not possible if programmed as SALTO KS

Water Resistance

- = Indoor version

R = IP66 Rating Water Resistant **(SKG*** & VDS Cylinders are already IP66 as standard)**

Model NxE1x

SALTO NEO Half cylinder Euro profile Electronic cylinder
(Can be initialized in SALTO SPACE or SALTO KS)

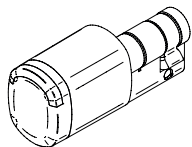

Technology	Model	Knob type	Outside length	Thumbturn	Inside length	Finish	Cams	Certification	Water resistance					
NB ¹ BLE DESFire Mifare	E1	1 Removable Knob	30	N No thumbturn	00 10mm	CSB	D	-	-	-				
			35											
			40											
			45											
			50		20	CPB	K							
			55											
			60											
			65											
			70											
			75											
			NJ ¹ BLE HID iCLASS Seos		E1	1 Removable Knob	95	N No thumbturn	30	BCB BioCote*	M ²	G*	SKG*** (IP66)	-
							1A (100mm.)		35					
1B (105mm.)														
1C (110mm.)	40	CSW		G										
1D (115mm.)														
1E (120mm.)														
1F (125mm.)														
1G (130mm.)	45	CPW					Z							
1H (135mm.)														
1I (140mm.)														
1J (145mm.)	50	PMW*	V* VDS Bz+ (IP66)	R* For outdoor use IP66										

Measures

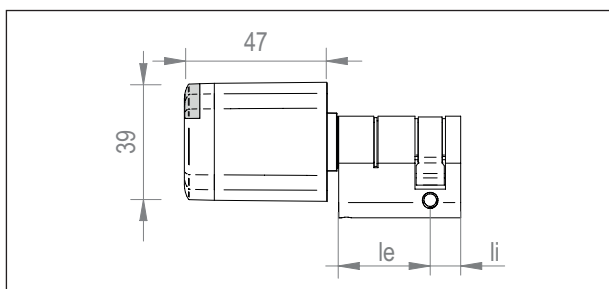

* This option has an additional price, please refer to the cylinder options chapter.

¹ Wireless BLUEnet ready.

² For spanish metal door.

M5 screw included.
For D and K cams 75mm length.
For M cam 35 mm length.

For total length > 50, the cylinder body might be modular
VDS certification is not possible if programmed as SALTO KS

Profile cylinder

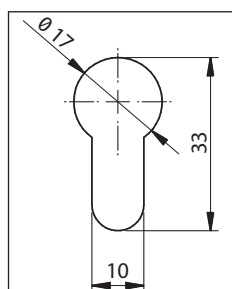

Cams

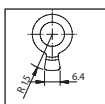

D cam

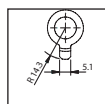

K cam

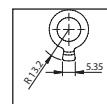

M cam

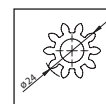

G cam

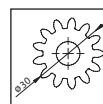

Z cam

Knob Type

1

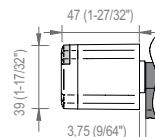

Model NxE1x

SALTO NEO Half cylinder Euro profile Electronic cylinder
 (Can be initialized in SALTO SPACE or SALTO KS)

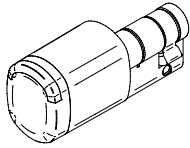

Prices - Gross prices

€



BLE DESFire MIFARE: **Standard** - standard length, standard cams, standard finish.

408,40



BLE HID iCLASS Seos: **Standard** - standard length, standard cams, standard finish.

556,75

Additional Prices - Gross prices

Water resistance

Ref	Remarks	€
R	Water resistant (IP66)	16,90

Length options

L(mm) Total	Remarks	€
40mm up to 60mm		0,00
from 65mm up to 100mm		20,60
length over 100 mm		Upon request

Certification

Ref	Remarks	€
G	SKG*** compliant (IP66)	33,90
V	VDS - Bz+ compliant (IP66) Not available yet - VDS version will be released at the end fo 2020.	33,90

Finish options

€

Satin Chromium Black reader	N x x x x CSB x x x	0,00
Satin Chromium White reader	N x x x x CSW x x x	
Polished Chromium Black reader	N x x x x CPB x x x	0,00
Polished Chromium White reader	N x x x x CPW x x x	
PVD Bright brass type Black reader	N x x x x PPB x x x	5,50
PVD Bright brass type White reader	N x x x x PPW x x x	
PVD Satin brass type Black reader	N x x x x PMB x x x	5,50
PVD Satin brass type White reader	N x x x x PMW x x x	
BioCoted Satin Chromium Black reader	N x x x x BCB x x x	40,80
Satin Chromium Black Black reader	N x x x x NEB x x x	8,65

Model NxE1xA

SALTO NEO half cylinder Euro profile Electronic cylinder
Antipanic function
(Can be initialized in SALTO SPACE or SALTO KS)

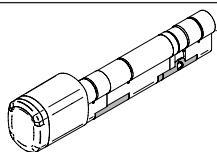

Technology	Model	Knob type	Outside length	Thumbturn	Inside length	Finish	Cams	Special function	Certification	Water resistance										
NB ¹ BLE DESFire MIFARE	E1	1 Removable Knob	30	N No thumbturn	35	CSB	D	A Panic function A	-	-										
			35																	
			40																	
			45																	
			50																	
			55																	
			60																	
			65																	
			70																	
			75																	
			95																	
			NJ ¹ BLE HID iCLASS Seos								E1	1 Removable Knob	1A -100mm.	N No thumbturn	65	NEB*	D	A Panic function A	G* SKG*** (IP66)	-
													1B-105mm.							
													1C-110mm.							
													1D-115mm.							
													1E-120mm.							
													1F-125mm.							
1G-130mm.																				
1H-135mm.																				
1I-140mm.																				
1J-145mm.																				
NJ ¹ BLE HID iCLASS Seos	E1	1 Removable Knob	1A -100mm.	N No thumbturn	70	CSW	D	A Panic function A	V* VDS Bz+ (IP66)	R* For outdoor use IP66										
			1B-105mm.																	
			1C-110mm.																	
			1D-115mm.																	
			1E-120mm.																	
			1F-125mm.																	
			1G-130mm.																	
			1H-135mm.																	
			1I-140mm.																	
			1J-145mm.																	

Measures

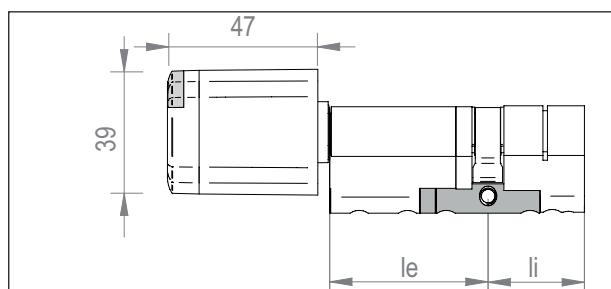

* This option has an additional price, please refer to the cylinder options chapter.

¹ Wireless BLUEnet ready.

M5 screw included.
For D cams 75mm length.

VDS certification is not possible if programmed as SALTO KS

Profile cylinder

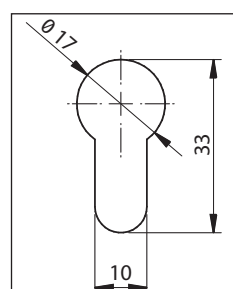

Antipanic function

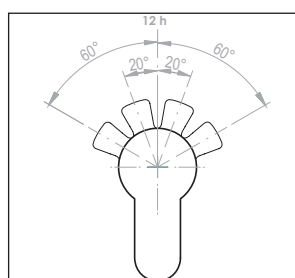

Antipanic function A

Cams

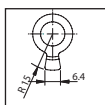

D cam

Knob Type

1

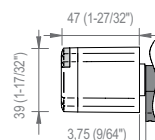

Model NxE1xA

SALTO NEO half cylinder Euro profile Electronic cylinder
Antipanic function
(Can be initialized in SALTO SPACE or SALTO KS)

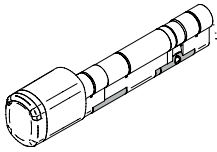

Prices - Gross prices

€



BLE DESFire MIFARE: Standard - standard length, standard cams, standard finish.

467,70



BLE HID iCLASS Seos: Standard - standard length, standard cams, standard finish.

616,15

Additional Prices - Gross prices

Water resistance

Ref	Remarks	€
R	Water resistant (IP66)	16,90

Certification

Ref	Remarks	€
G	SKG*** compliant (IP66)	33,90
V	VDS - Bz+ compliant (IP66) Not available yet - VDS version will be released at the end fo 2020.	33,90

Length options

L(mm) Total	Remarks	€
40mm up to 80mm		0,00
from 85mm up to 100mm		20,60
from 105 mm up to 120 mm		54,85
from 125 mm up to 145 mm		109,60
lenght over 150 mm		Upon request

Finish options

€

Satin Chromium Black reader	N x x x x CSB x x x	0,00
Satin Chromium White reader	N x x x x CSW x x x	
Polished Chromium Black reader	N x x x x CPB x x x	0,00
Polished Chromium White reader	N x x x x CPW x x x	
PVD Bright brass type Black reader	N x x x x PPB x x x	5,50
PVD Bright brass type White reader	N x x x x PPW x x x	
PVD Satin brass type Black reader	N x x x x PMB x x x	5,50
PVD Satin brass type White reader	N x x x x PMW x x x	
BioCoted Satin Chromium Black reader	N x x x x BCB x x x	40,80
Satin Chromium Black Black reader	N x x x x NEB x x x	8,65

Model NxE2x

SALTO NEO Euro profile electronic cylinder
 Standard cylinder, one knob, one thumbturn
 (Can be initialized in SALTO SPACE or SALTO KS)

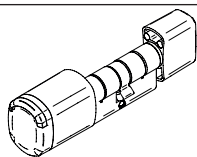

Technology	Model	Knob type	Outside length	Thumbturn	Inside length	Finish	Cams	Certification	Water resistance	
NB ¹ BLE DESFire Mifare	E2	1 Removable Knob	30	S Standard	10	CSB	D	-	-	
			35		15					
			40		20					
			45		25					
			50		30					
			55		35					
			60		40					
			65		45					
			·		·	K				No Certification
			·	·						
			·	·						
			·	·						
			·	·						
			NJ ¹ BLE HID iCLASS Seos	E2	1 Removable Knob	1C (110mm.)	R* Round	1C (110mm.)	CSW	G
1D (115mm.)	1D (115mm.)									
1E (120mm.)	1E (120mm.)									
1F (125mm.)	1F (125mm.)									
1G (130mm.)	1G (130mm.)									
1H (135mm.)	1H (135mm.)									
1I (140mm.)	1I (140mm.)									
1J (145mm.)	1J (145mm.)									
1K (150mm.)	1K (150mm.)									
·	·	Z				SKG*** (IP66)				
·	·									
·	·									
·	·									
·	·									
·	·	V* VDS Bz+ (IP66)	R*							
·	·									
·	·									
·	·									
·	·									

Measures

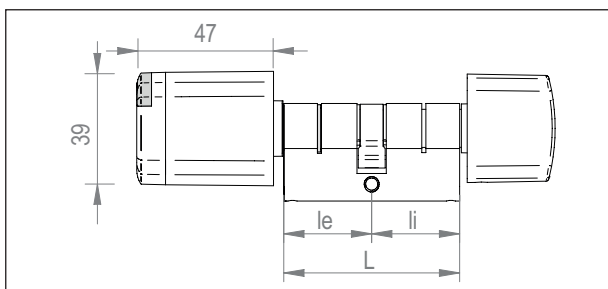

* This option has an additional price, please refer to the cylinder options chapter.

¹ Wireless BLUENet ready.

² For spanish metal door.

For total length > to 85, the cylinder body might be modular

M5 screw included.

For D cams 75mm length.

For M cams 35mm length.

VDS certification is not possible if programmed as SALTO KS

Profile cylinder

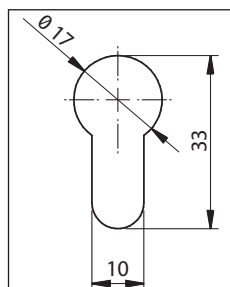

Cams

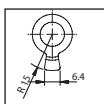

D cam

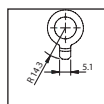

K cam

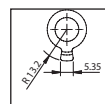

M cam

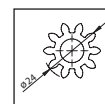

G cam

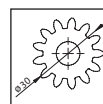

Z cam

Knob Type

1

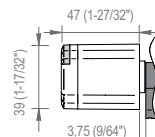

Model NxE2x

SALTO NEO Euro profile electronic cylinder
Standard cylinder, one knob, one thumbturn
(Can be initialized in SALTO SPACE or SALTO KS)

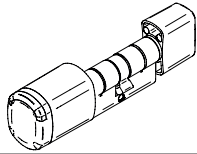

Prices - Gross prices

€



BLE DESFire MIFARE: **Standard** - standard length, standard cams, standard finish.

419,75



BLE HID iCLASS Seos: **Standard** - standard length, standard cams, standard finish.

568,30

Additional Prices - Gross prices

Water resistance

Ref	Remarks	€
R	Water resistant (IP66)	16,90

Certification

Ref	Remarks	€
G	SKG*** compliant (IP66)	33,90
V	VDS - Bz+ compliant (IP66) Not available yet - VDS version will be released at the end fo 2020.	33,90

Length options

L(mm) Total	Remarks	€
40mm up to 80mm		0,00
from 85mm up to 100mm		20,60
from 105 mm up to 120 mm		54,85
from 125 mm up to 145 mm		109,60
length over 150 mm		Upon request

Finish options

		€
Satin Chromiun Black reader	N x x x x CSB x x x	0,00
Satin Chromiun White reader	N x x x x CSW x x x	
Polished Chromiun Black reader	N x x x x CPB x x x	0,00
Polished Chromiun White reader	N x x x x CPW x x x	
PVD Bright brass type Black reader	N x x x x PPB x x x	5,50
PVD Bright brass type White reader	N x x x x PPW x x x	
PVD Satin brass type Black reader	N x x x x PMB x x x	5,50
PVD Satin brass type White reader	N x x x x PMW x x x	
BioCoted Satin Chromiun Black reader	N x x x x BCB x x x	40,80
Satin Chromiun Black Black reader	N x x x x NEB x x x	8,65

Thumbturns

	€
S 	0,00
R 	6,90

Allen key to remove the thumbturn

Reference	Quantity	€
SP301585	1	2,40

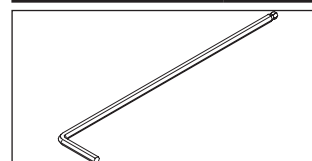

Model NxE2xA

SALTO NEO Euro profile electronic cylinder
 Antipanic function - Standard cylinder, one knob, one thumbturn
 (Can be initialized in SALTO SPACE or SALTO KS)

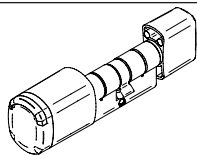

Technology	Model	Knob type	Outside length	Thumbturn	Inside length	Finish	Cams	Special function	Certification	Water resistance	
NB ¹ BLE DESFire MIFARE	E2	1 Removable Knob	30	S Standard	35	CSB	D	A Panic function A	-	-	-
			35								
			40								
			45								
			50								
			55								
			60								
			65								
			70								
			75								
NJ ¹ BLE HID iCLASS Seos	E2	1 Removable Knob	95	R* Round	65	NEB*	D	A Panic function A	G* SKG*** (IP66)	-	-
			1A -100mm.								
			1B-105mm.								
			1C-110mm.								
			1D-115mm.								
			1E-120mm.								
			1F-125mm.								
			1G-130mm.								
			1H-135mm.								
			1I-140mm.								
1J-145mm.											
	E2	1 Removable Knob	100	R* Round	70	CSW	D	A Panic function A	V* VDS Bz+ (IP66)	R*	For outdoor use IP66
			105								
			110								
			115								
			120								
			125								
			130								
			135								
			140								
			145								

Measures

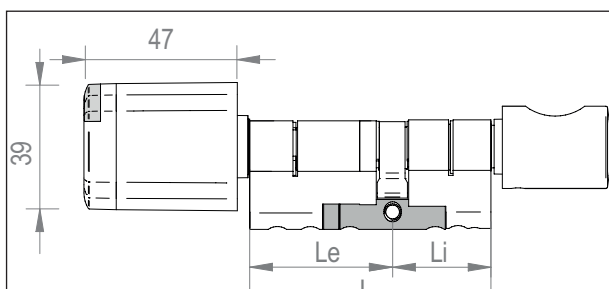

* This option has an additional price, please refer to the cylinder options chapter.
¹ Wireless BLUENet ready.
² Version not available.

M5 screw included.
 For D cams 75mm length.

VDS certification is not possible if programmed as SALTO KS

Profile cylinder

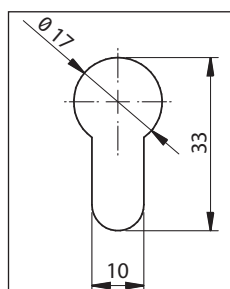

Antipanic function

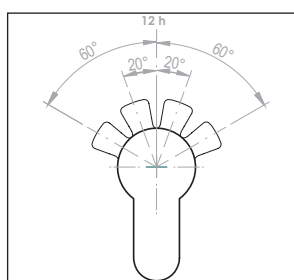

Antipanic function A

Cams

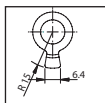

D cam

Knob Type

1

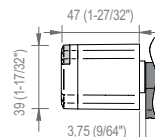

Model NxE2xA

SALTO NEO Euro profile electronic cylinder
Antipanic function - Standard cylinder, one knob, one thumbturn
(Can be initialized in SALTO SPACE or SALTO KS)

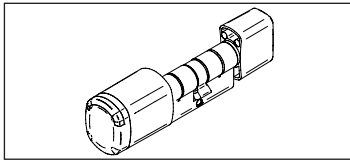

Prices - Gross prices		€
	BLE DESFire MIFARE: Standard - standard length, standard cams, standard finish.	479,05
	BLE HID iCLASS Seos: Standard - standard length, standard cams, standard finish.	627,55

Additional Prices - Gross prices

Water resistance

Ref	Remarks	€
R	Water resistant (IP66)	16,90

Certification

Ref	Remarks	€
G	SKG*** compliant (IP66)	33,90
V	VDS - Bz+ compliant (IP66) Not available yet - VDS version will be released at the end fo 2020.	33,90

Finish options

		€
Satin Chromiun Black reader	N x x x x CSB x x x	0,00
Satin Chromiun White reader	N x x x x CSW x x x	0,00
Polished Chromiun Black reader	N x x x x CPB x x x	0,00
Polished Chromiun White reader	N x x x x CPW x x x	0,00
PVD Bright brass type Black reader	N x x x x PPB x x x	5,50
PVD Bright brass type White reader	N x x x x PPW x x x	5,50
PVD Satin brass type Black reader	N x x x x PMB x x x	5,50
PVD Satin brass type White reader	N x x x x PMW x x x	5,50
BioCoted Satin Chromiun Black reader	N x x x x BCB x x x	40,80
Satin Chromiun Black Black reader	N x x x x NEB x x x	8,65

Length options

L(mm) Total	Remarks	€
65mm up to 80mm		0,00
from 85mm up to 100mm		20,60
from 105 mm up to 120 mm		54,85
from 125 mm up to 145 mm		109,60
length over 150 mm		Upon request

Thumbturns

	€
S	0,00
R	6,90

Allen key to remove the thumbturn

Reference	Quantity	€
SP301585	1	2,40

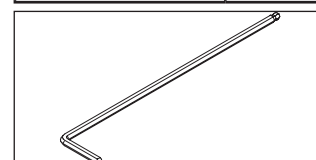

Model NxE2xK

SALTO NEO Euro profile electronic cylinder
AMOK function - Standard cylinder, one knob, one thumbturn
(Can be initialized in SALTO SPACE or SALTO KS)

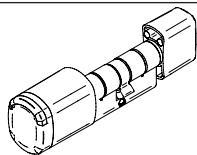

Technology	Model	Knob type	Outside length	Thumbturn	Inside length	Finish	Cams	Special function	Certification	Water resistance
NB ¹ BLE DESFire MIFARE	E2	1 Removable Knob	30	S Standard	35	CSB	D	K	-	-
			35							
			40							
			45							
			50							
			55							
			60							
			65							
			70							
			75							
NJ ¹ BLE HID iCLASS Seos	E2	1 Removable Knob	95	R* Round	65	NEB*	D	K	No certification	R* For outdoor use IP66
			1A -100mm.							
			1B-105mm.							
			1C-110mm.							
			1D-115mm.							
			1E-120mm.							
			1F-125mm.							
			1G-130mm.							
			1H-135mm.							
			1I-140mm.							
1J-145mm.										
	E2	1 Removable Knob	1A-100mm.	R* Round	70	CSW	D	K	-	-
			1B-105mm.							
			1C-110mm.							
			1D-115mm.							
			1E-120mm.							
			1F-125mm.							
			1G-130mm.							
			1H-135mm.							
			1I-140mm.							
			1J-145mm.							
	E2	1 Removable Knob	1A-100mm.	R* Round	75	CPW	D	K	-	-
			1B-105mm.							
			1C-110mm.							
			1D-115mm.							
			1E-120mm.							
			1F-125mm.							
			1G-130mm.							
			1H-135mm.							
			1I-140mm.							
			1J-145mm.							
	E2	1 Removable Knob	1A-100mm.	R* Round	95	PPW*	D	K	-	-
			1B-105mm.							
			1C-110mm.							
			1D-115mm.							
			1E-120mm.							
			1F-125mm.							
			1G-130mm.							
			1H-135mm.							
			1I-140mm.							
			1J-145mm.							
	E2	1 Removable Knob	1A-100mm.	R* Round	1A-100mm.	PMW*	D	K	-	-
			1B-105mm.							
			1C-110mm.							
			1D-115mm.							
			1E-120mm.							
			1F-125mm.							
			1G-130mm.							
			1H-135mm.							
			1I-140mm.							
			1J-145mm.							

Measures

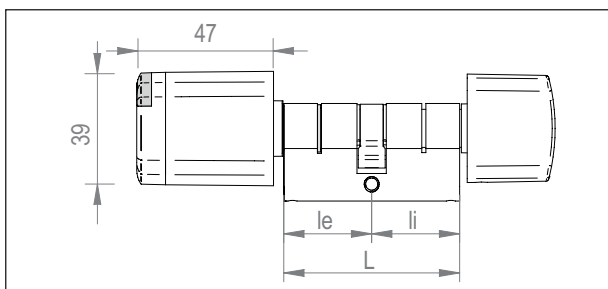

* This option has an additional price, please refer to the cylinder options chapter.
¹ Wireless BLUEnet ready.

M5 screw included.
For D and K cams 75mm length.

For total length > 85, the cylinder body might be modular

Profile cylinder

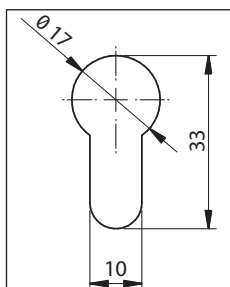

Cams

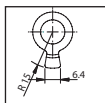

D cam

Knob Type

1

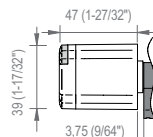

Model NxE2xK

SALTO NEO Euro profile electronic cylinder
AMOK function - Standard cylinder, one knob, one thumbturn
(Can be initialized in SALTO SPACE or SALTO KS)

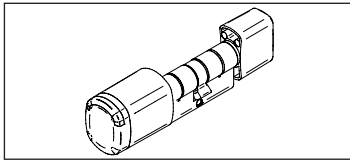

Prices - Gross prices		€
MIFARE DESFire	BLE DESFire MIFARE: Standard - standard length, standard cams, standard finish.	523,00
BLE HID iCLASS Seos	BLE HID iCLASS Seos: Standard - standard length, standard cams, standard finish.	671,45

Additional Prices - Gross prices

Water resistance

Ref	Remarks	€
R	Water resistant (IP66)	16,90

Finish options

		€
Satin Chromiun Black reader	N x x x x CSB x x x	0,00
Satin Chromiun White reader	N x x x x CSW x x x	0,00
Polished Chromiun Black reader	N x x x x CPB x x x	0,00
Polished Chromiun White reader	N x x x x CPW x x x	5,50
PVD Bright brass type Black reader	N x x x x PPB x x x	5,50
PVD Bright brass type White reader	N x x x x PPW x x x	40,80
PVD Satin brass type Black reader	N x x x x PMB x x x	8,65
PVD Satin brass type White reader	N x x x x PMW x x x	
BioCoted Satin Chromiun Black reader	N x x x x BCB x x x	
Satin Chromiun Black Black reader	N x x x x NEB x x x	

Length options

L(mm) Total	Remarks	€
65mm up to 80mm		0,00
from 85mm up to 100mm		20,60
from 105 mm up to 120 mm		54,85
from 125 mm up to 145 mm		109,60
length over 150 mm		Upon request

Thumbturns

	€
S	0,00
R	6,90

Allen key to remove the thumbturn

Reference	Quantity	€
SP301585	1	2,40

Model NxE3x

SALTO NEO Electronic Euro profile double cylinder
 Standard cylinder, two knob.
 (Can be initialized in SALTO SPACE or SALTO KS)

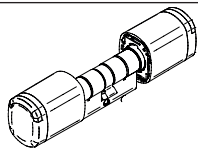

Technology	Model	Knob type	Outside length	Thumbturn	Inside length	Finish	Cams	Certification	Water resistance						
NB ¹ BLE DESFire Mifare	E3	1 Removable Knob	30	N No thumbturn	30	CSB	D	-	-						
			35		35										
			40		40	CPB									
			45		45										
			50		50	K									
			55		55										
			60		60										
			65		65										
			NJ ¹ BLE HID iCLASS Seos		E3	1 Removable Knob	·			N No thumbturn	·	BCB BioCote*	M ²	G*	-
							·				·	NEB*			
							1C (110mm.)				1C (110mm.)		CSW		
							1D (115mm.)				1D (115mm.)	G			
							1E (120mm.)				1E (120mm.)		CPW		
							1F (125mm.)				1F (125mm.)	Z			
1G (130mm.)	1G (130mm.)														
1H (135mm.)	1H (135mm.)														
1I (140mm.)	1I (140mm.)														
1J (145mm.)	1J (145mm.)	V*													
1K (150mm.)	1K (150mm.)			PMW*											
		VDS Bz+													
		(IP66)													
		R*													
		For outdoor use IP66													

Measures

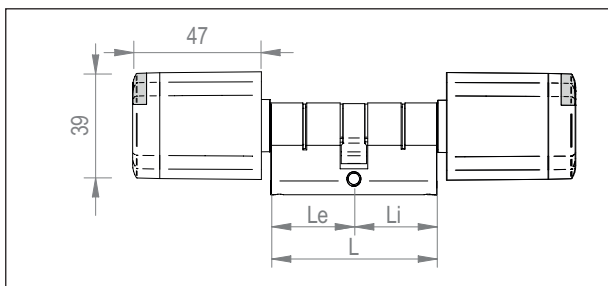

* This option has an additional price, please refer to the cylinder options chapter.

¹ Wireless BLUEnet ready.

³ For spanish metal door.

M5 screw included.

For D and K cams 75mm length.

For M cam 35 mm length.

For total length > 85, the cylinder body might be modular

VDS certification is not possible if programmed as SALTO KS

Profile cylinder

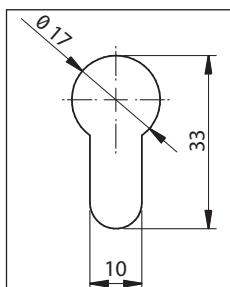

Cams

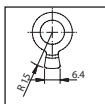

D cam

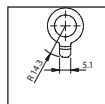

K cam

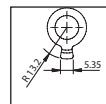

M cam

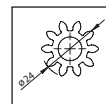

G cam

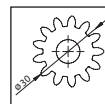

Z cam

Knob Type

1

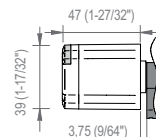

Model NxE3x

SALTO NEO Electronic Euro profile double cylinder
Standard cylinder, two knob.
(Can be initialized in SALTO SPACE or SALTO KS)

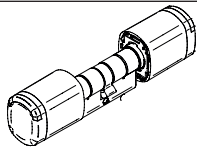

Prices - Gross prices

€



BLE DESFire MIFARE: Standard - standard length, standard cams, standard finish.

526,40



BLE HID iCLASS Seos: Standard - standard length, standard cams, standard finish.

674,85

Additional Prices - Gross prices

Water resistance

Ref	Remarks	€
R	Water resistant (IP66)	16,90

Certification

Ref	Remarks	€
G	SKG*** compliant (IP66)	33,90
V	VDS - Bz+ compliant (IP66) Not available yet - VDS version will be released at the end fo 2020.	33,90

Length options

L(mm) Total	Remarks	€
40mm up to 80mm		0,00
from 85mm up to 100mm		20,60
from 105 mm up to 120 mm		54,85
from 125 mm up to 145 mm		109,60
length over 150 mm		Upon request

Finish options

€

Satin Chromium Black reader	N x x x x CSB x x x	0,00
Satin Chromium White reader	N x x x x CSW x x x	
Polished Chromium Black reader	N x x x x CPB x x x	0,00
Polished Chromium White reader	N x x x x CPW x x x	
PVD Bright brass type Black reader	N x x x x PPB x x x	5,50
PVD Bright brass type White reader	N x x x x PPW x x x	
PVD Satin brass type Black reader	N x x x x PMB x x x	5,50
PVD Satin brass type White reader	N x x x x PMW x x x	
BioCoted Satin Chromium Black reader	N x x x x BCB x x x	40,80
Satin Chromium Black Black reader	N x x x x NEB x x x	8,65

Model NxE9x

SALTO NEO Electronic half cylinder for server rack swing handles
(Can be initialized in SALTO SPACE or SALTO KS)

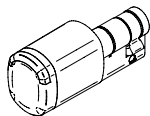

Technology	Model	Knob type	Outside length	Thumbturn	Inside length	Finish	Cams	Certification	Water resistance
NB¹ BLE DESFire Mifare	E9	1 Removable Knob	30	N No thumbturn	00 10 mm	CSB	R	-	-
			35			CPB			
NJ¹ BLE HID iCLASS Seos	E9	1 Removable Knob	35	N No thumbturn	00 10 mm	PPB*	R	No certification	R* For outdoor use IP66
						PMB*			
						BCB BioCote*			
						NEB*			
						CSW			
						CPW			
PPW*									
						PMW*			

Measures

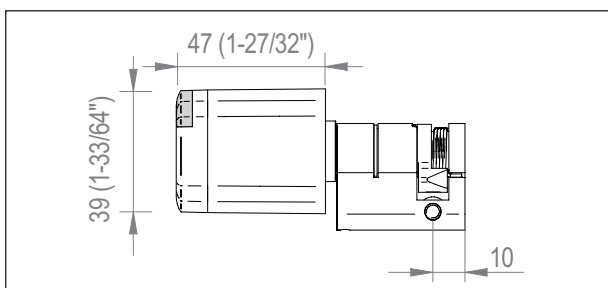

* This option has an additional price, please refer to the cylinder options chapter.

¹ Wireless BLUEnet ready.

M5X45 screw included

**Swing handle not included-
SALTO does not provide swing handles**

Profile cylinder

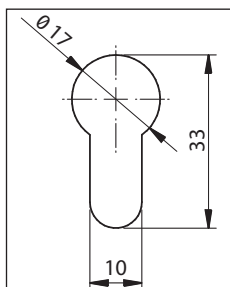

Cams

R cam

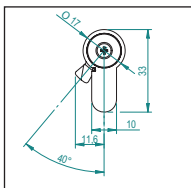

Knob Type

1

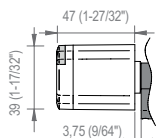

	Profile cylinders	Swinghandles
DIRAK®*	A- A1 - B - F, type	2-080.01, 2-080.02, 2-090, 2-100.01, 2-120, 2-300, 2-340, 2-400 o 3-150, 3-153, 3-155.02, 3-170
EMKA®*	3XB-120, 3XB-220, 3XB-320	3A-120, 3A-220, 3A-310, 3A-320, 3B-220, 3B-320, 3C-220, 3C-260, 3C-280, 3C-320, 3G-220, 3F-430

Model NxE9x

SALTO NEO Electronic half cylinder for server rack swing handles
(Can be initialized in SALTO SPACE or SALTO KS)

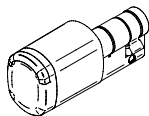

Prices - Gross prices

€



BLE DESFire MIFARE: Standard - standard length, standard cams, standard finish.

435,60



BLE HID iCLASS Seos: Standard - standard length, standard cams, standard finish.

583,90

Additional Prices - Gross prices

Water resistance

Ref	Remarks	€
R	Water resistant (IP66)	16,90

Finish options

€

Satin Chromium Black reader	N x x x x CSB x x x	0,00
Satin Chromium White reader	N x x x x CSW x x x	
Polished Chromium Black reader	N x x x x CPB x x x	0,00
Polished Chromium White reader	N x x x x CPW x x x	
PVD Bright brass type Black reader	N x x x x PPB x x x	5,50
PVD Bright brass type White reader	N x x x x PPW x x x	
PVD Satin brass type Black reader	N x x x x PMB x x x	5,50
PVD Satin brass type White reader	N x x x x PMW x x x	
BioCoted Satin Chromium Black reader	N x x x x BCB x x x	40,80
Satin Chromium Black Black reader	N x x x x NEB x x x	8,65

Model NxCLx

SALTO NEO Cam lock electronic cylinder
(Can be initialized in SALTO SPACE or SALTO KS)

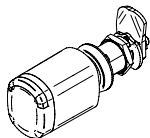

Technology	Model	Knob type	Cylinder body Ø	Door thickness	Cam height	Finish	Cams	Certification	Water resistance
NB ¹ BLE DESFire Mifare	CL	1 Removable Knob	19	M 1mm to 15mm	28 28mm	CSB	A	-	-
						CPB			
						PPB*			
						PMB*			
						BCB BioCote*			
NJ ¹ BLE HID iCLASS Seos	CL	1 Removable Knob	19	W 15mm < t < 22mm	40 40mm	NEB*	A	No certification	R*
						CSW			
						CPW			
						PPW*			
						PMW*			

Measures

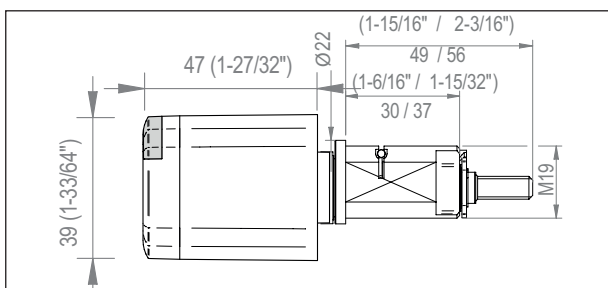

* This option has an additional price, please refer to the cylinder options chapter.
¹ Wireless BLUEnet ready.

CAM and Security collars included

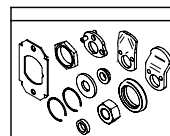

Profile cylinder

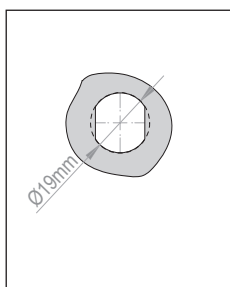

Knob Type

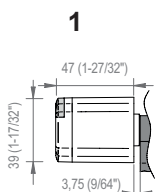

Distance C range depending on t		
	t Door thickness	c Door strike distance
A	1 to 14	22 < c < 40mm 7/8' < c < 1-9/16'
	15 to 22	29 < c < 47mm 1-3/16' < c < 1-7/8'

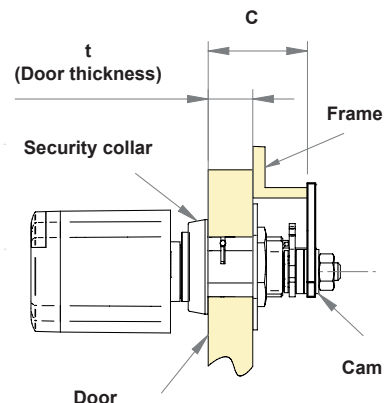

Model NxCLx	SALTO NEO Cam lock electronic cylinder (Can be initialized in SALTO SPACE or SALTO KS)
--------------------	---

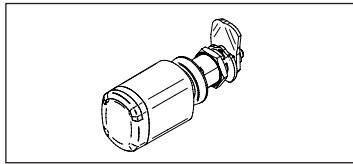

Prices - Gross prices		€
	BLE Mifare DESFire: Standard - standard length, standard cams, standard finish.	439,80
	BLE HID iCLASS: Standard - standard length, standard cams, standard finish.	588,30

Additional Prices - Gross prices

Water resistance

Ref	Remarks	€
R	Water resistant (IP66)	16,90

Cam lock strike plate

Reference	Quantity	€
SP221386-10	10	102,50

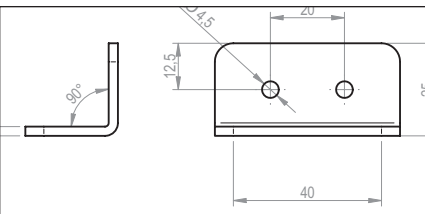

Standard cams

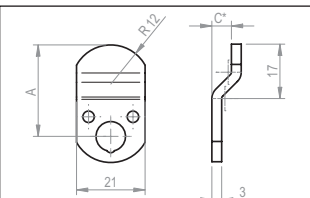

REF.	QTY (min 20)	A	C*	€
SP221220-0120	20	28	0	121,40
SP221220-0220	20	40	0	121,40
SP221150-0120	20	28	6	121,40
SP221150-0220	20	40	6	121,40

Finish options

		€
Satin Chromiun Black reader	N x x x x CSB x x x	0,00
Satin Chromiun White reader	N x x x x CSW x x x	0,00
Polished Chromiun Black reader	N x x x x CPB x x x	0,00
Polished Chromiun White reader	N x x x x CPW x x x	0,00
PVD Bright brass type Black reader	N x x x x PPB x x x	5,50
PVD Bright brass type White reader	N x x x x PPW x x x	5,50
PVD Satin brass type Black reader	N x x x x PMB x x x	5,50
PVD Satin brass type White reader	N x x x x PMW x x x	5,50
BioCoted Satin Chromiun Black reader	N x x x x BCB x x x	40,80
Satin Chromiun Black Black reader	N x x x x NEB x x x	8,65

Customized cam lock

SALTO offers the possibility to order customized cams for SALTO cam lock cylinders. Please request for a quotation by detailing the dimensions and characteristics of the cam by sending this information to SALTO.

CUSTOMIZED CAMS

QUANT. (min 20)	DIMENSIONS				
	A (≥30)	B (≥21)	C*	R ≥ (2B/3)	E ≤ (A-10)

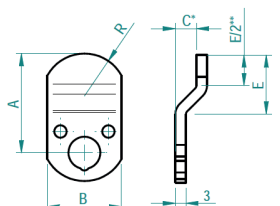

*C=0 (STRAIGHT CAM)
** Recommended straight part length = E/2
Other Cam shapes under request.

Model NxU1x

SALTO NEO UK oval profile half electronic cylinder
One knob, no thumbturn.
(Can be initialized in SALTO SPACE or SALTO KS)

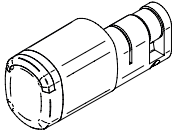

Technology	Model	Knob type	Outside length	Thumbturn	Inside length	Finish	Cams	Certification	Water resistance									
NB ¹ BLE DESFire Mifare	U1	1 Removable Knob	30	N No thumbturn	00 10mm	CSB	K	-	-									
			35															
			40															
			45															
			50															
			55															
			60															
			65															
			70															
			75															
			95															
			NJ ¹ BLE HID iCLASS Seos							U1	1 Removable Knob	1A (100mm.)	N No thumbturn	00 10mm	NEB*	K	-	-
												1B (105mm.)						
1C (110mm.)																		
1D (115mm.)																		
1E (120mm.)																		
1F (125mm.)																		
1G (130mm.)																		
1H (135mm.)																		
1I (140mm.)																		
1J (145mm.)																		
						CSW												
						CPW												
						PPW*												
						PMW*												
									R*									

Measures

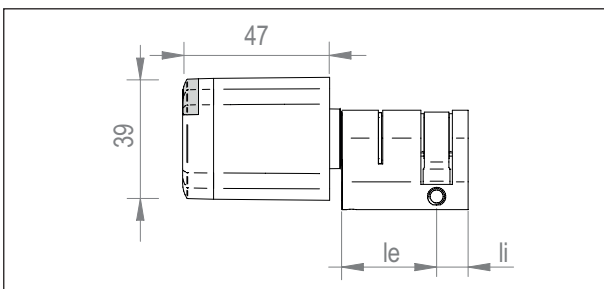

* This option has an additional price, please refer to the cylinder options chapter.

¹ Wireless BLUEnet ready.

M5 screw included.
For K cams 75mm length.

Profile cylinder

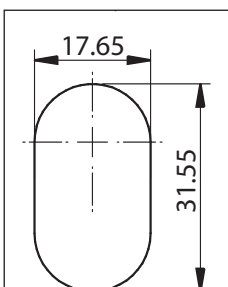

Cams

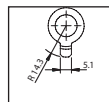



K cam

Knob Type

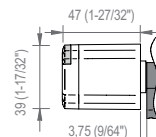
1

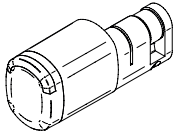

Model NxU1x	SALTO NEO UK oval profile half electronic cylinder One knob, no thumbturn. (Can be initialized in SALTO SPACE or SALTO KS)
	

Prices - Gross prices		€
	BLE DESFire MIFARE: Standard - standard length, standard cams, standard finish.	422,15
	BLE HID iCLASS Seos: Standard - standard length, standard cams, standard finish.	570,50

Additional Prices - Gross prices

Water resistance

Ref	Remarks	€
R	Water resistant (IP66)	16,90

Length options

L(mm) Total	Remarks	€
40mm up to 60mm		0,00
from 65mm up to 100mm		20,60
length over 100 mm		Upon request

Finish options

		€
Satin Chromium Black reader	N x x x x CSB x x x	0,00
Satin Chromium White reader	N x x x x CSW x x x	
Polished Chromium Black reader	N x x x x CPB x x x	0,00
Polished Chromium White reader	N x x x x CPW x x x	
PVD Bright brass type Black reader	N x x x x PPB x x x	5,50
PVD Bright brass type White reader	N x x x x PPW x x x	
PVD Satin brass type Black reader	N x x x x PMB x x x	5,50
PVD Satin brass type White reader	N x x x x PMW x x x	
BioCoted Satin Chromium Black reader	N x x x x BCB x x x	40,80
Satin Chromium Black Black reader	N x x x x NEB x x x	8,65

Model NxU2x

SALTO NEO UK oval profile electronic cylinder
 Standard cylinder, one knob, one thumbturn.
 (Can be initialized in SALTO SPACE or SALTO KS)

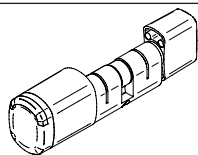

Technology	Model	Knob type	Outside length	Thumbturn	Inside length	Finish	Cams	Certification	Water resistance
NB ¹ BLE DESFire Mifare	U2	1 Removable Knob	30	S Standard	10	CSB	K	-	-
			35		15				
			40		20				
			45		25	CPB			
			50		30				
			55		35	PPB*			
			60		40				
			65		45	PMB*			
			70		·				
			75		·	BCB BioCote*			
			95		·				
NJ ¹ BLE HID iCLASS Seos	U2	1 Removable Knob	1A (100mm.)	R* Round	1C (110mm.)	NEB*	-	No certification	-
			1B (105mm.)		1D (115mm.)				
			1C (110mm.)		1E (120mm.)	CSW			
			1D (115mm.)		1F (125mm.)				
			1E (120mm.)		1G (130mm.)	CPW			
			1F (125mm.)		1H (135mm.)				
			1G (130mm.)		1I (140mm.)	PPW*			
			1H (135mm.)		1J (145mm.)				
			1I (140mm.)		1K (150mm.)	PMW*			
			1J (145mm.)						

Measures

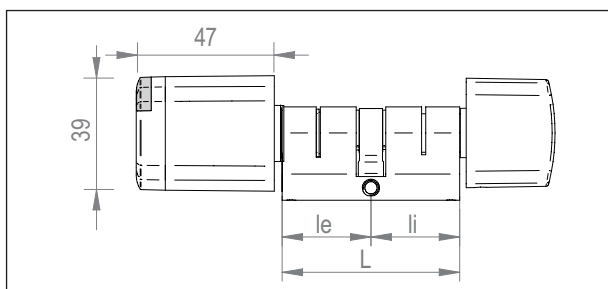

* This option has an additional price, please refer to the cylinder options chapter.
¹ Wireless BLUENet ready.
 M5 x 75mm screw included.

Profile cylinder

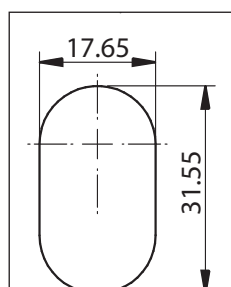

Cams

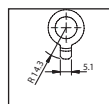

K cam

Knob Type

1

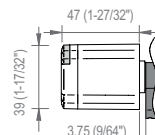

Model NxU2x	SALTO NEO UK oval profile electronic cylinder Standard cylinder, one knob, one thumbturn. (Can be initialized in SALTO SPACE or SALTO KS)
--------------------	---

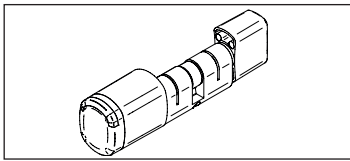

Prices - Gross prices		€
MIFARE DESFire	BLE DESFire MIFARE: Standard - standard length, standard cams, standard finish.	439,80
BLE HID iCLASS Seos	BLE HID iCLASS Seos: Standard - standard length, standard cams, standard finish.	588,30

Additional Prices - Gross prices

Water resistance

Ref	Remarks	€
R	Water resistant (IP66)	16,90

Length options

L(mm) Total	Remarks	€
40mm up to 80mm		0,00
from 85mm up to 100mm		20,60
from 105 mm up to 120 mm		54,85
from 125 mm up to 145 mm		109,60
length over 150 mm		Upon request

Finish options

		€
Satin Chromiun Black reader	N x x x x CSB x x x	0,00
Satin Chromiun White reader	N x x x x CSW x x x	
Polished Chromiun Black reader	N x x x x CPB x x x	0,00
Polished Chromiun White reader	N x x x x CPW x x x	
PVD Bright brass type Black reader	N x x x x PPB x x x	5,50
PVD Bright brass type White reader	N x x x x PPW x x x	
PVD Satin brass type Black reader	N x x x x PMB x x x	5,50
PVD Satin brass type White reader	N x x x x PMW x x x	
BioCoted Satin Chromiun Black reader	N x x x x BCB x x x	40,80
Satin Chromiun Black Black reader	N x x x x NEB x x x	8,65

Thumbturns

		€
S		0,00
R		6,90

Allen key to remove the thumbturn

Reference	Quantity	€
SP301585	1	2,40

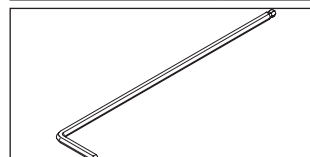

Model NxU3x

SALTO NEO UK oval profile electronic double cylinder
Standard cylinder, two knob.
(Can be initialized in SALTO SPACE or SALTO KS)

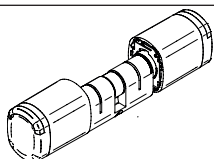

Technology	Model	Knob type	Outside length	Thumbturn	Inside length	Finish	Cams	Certification	Water resistance		
NB ¹ BLE DESFire Mifare	U3	1 Removable Knob	30	N No thumbturn	30	CSB	K	-	-		
			35		35						
			40		40	CPB					
			45		45						
			50		50	PPB*					
			55		55						
			60		60	PMB*					
			65		65						
			70		70	BCB BioCote*					
			75		75						
			95		95	NEB*					
			NJ ¹ BLE HID iCLASS Seos		1A (100mm.)					1A (100mm.)	
					1B (105mm.)					1B (105mm.)	
					1C (110mm.)					1C (110mm.)	CSW
					1D (115mm.)					1D (115mm.)	
					1E (120mm.)					1E (120mm.)	CPW
					1F (125mm.)					1F (125mm.)	
1G (130mm.)	1G (130mm.)	PPW*									
1H (135mm.)	1H (135mm.)										
1I (140mm.)	1I (140mm.)	PMW*									
1J (145mm.)	1J (145mm.)										

Measures

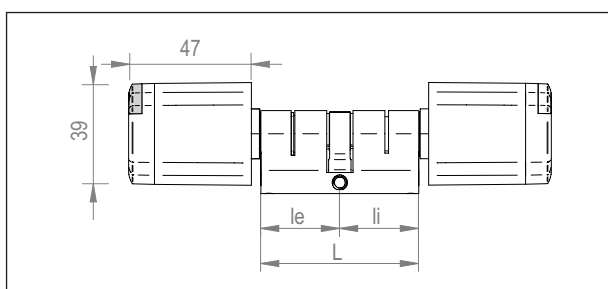

* This option has an additional price, please refer to the cylinder options chapter.
¹ Wireless BLUEnet ready.
M5 x 75mm screw included.

Profile cylinder

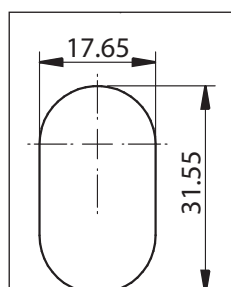

Cams

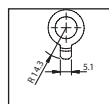

K cam

Knob Type

1

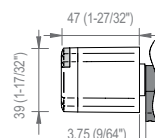

Model NxU3x	SALTO NEO UK oval profile electronic double cylinder Standard cylinder, two knob. (Can be initialized in SALTO SPACE or SALTO KS)
--------------------	---

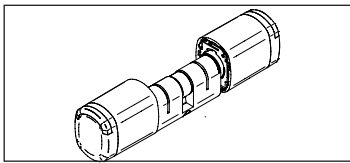

Prices - Gross prices		€
	BLE DESFire MIFARE: Standard - standard length, standard cams, standard finish.	526,40
	BLE HID iCLASS Seos: Standard - standard length, standard cams, standard finish.	674,85

Additional Prices - Gross prices

Water resistance

Ref	Remarks	€
R	Water resistant (IP66)	16,90

Length options

L(mm) Total	Remarks	€
40mm up to 80mm		0,00
from 85mm up to 100mm		20,60
from 105 mm up to 120 mm		54,85
from 125 mm up to 145 mm		109,60
length over 150 mm		Upon request

Finish options

		€
Satin Chromium Black reader	N x x x x CSB x x x	0,00
Satin Chromium White reader	N x x x x CSW x x x	
Polished Chromium Black reader	N x x x x CPB x x x	0,00
Polished Chromium White reader	N x x x x CPW x x x	
PVD Bright brass type Black reader	N x x x x PPB x x x	5,50
PVD Bright brass type White reader	N x x x x PPW x x x	
PVD Satin brass type Black reader	N x x x x PMB x x x	5,50
PVD Satin brass type White reader	N x x x x PMW x x x	
BioCoted Satin Chromium Black reader	N x x x x BCB x x x	40,80
Satin Chromium Black Black reader	N x x x x NEB x x x	8,65

Model NxH1x

SALTO NEO Swiss profile half electronic cylinder
 One knob, no thumbturn.
 (Can be initialized in SALTO SPACE or SALTO KS)

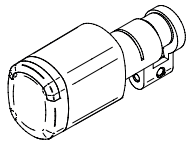

Technology	Model	Knob type	Outside length	Thumbturn	Inside length	Finish	Cams	Certification	Water resistance						
NB ¹ BLE DESFire Mifare	H1	1 Removable Knob	30	N No thumbturn	00 10mm	CSB	H	-	For indoor use						
			35							CPB					
			40												
			45			PPB*									
			50												
			55			PMB*									
			60												
			65												
			NJ ¹ BLE HID iCLASS Seos			H1	1 Removable Knob	70	N No thumbturn	00 10mm	BCB BioCote*	G	-	For indoor use	
								75							NEB*
								95							
								1A (100mm.)			CSW				
								1B (105mm.)							
1C (110mm.)	CPW														
1D (115mm.)															
1E (120mm.)															
1F (125mm.)	PPW*														
1G (130mm.)															
1H (135mm.)															
1I (140mm.)	Z														
1J (145mm.)															
								R*	For outdoor use IP66						

Measures

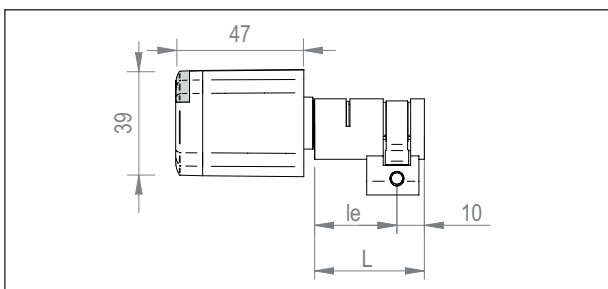

* This option has an additional price, please refer to the cylinder options chapter.
¹ Wireless BLUENet ready.
 M5 x 75mm screw included.

Profile cylinder

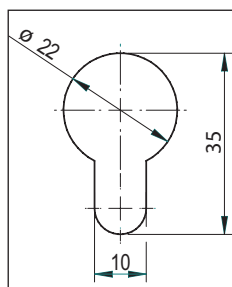

Cams

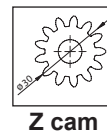
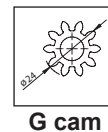
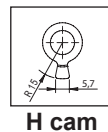

Knob Type

1

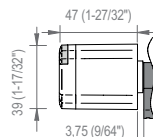

Model NxH1x	SALTO NEO Swiss profile half electronic cylinder One knob, no thumbturn. (Can be initialized in SALTO SPACE or SALTO KS)
--------------------	--

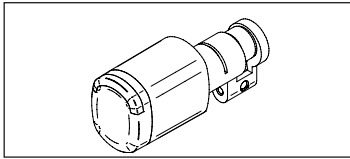

Prices - Gross prices		€
MIFARE DESFire	BLE DESFire MIFARE: Standard - standard length, standard cams, standard finish.	408,40
BLE HID iCLASS Seos	BLE HID iCLASS Seos: Standard - standard length, standard cams, standard finish.	556,75

Additional Prices - Gross prices

Water resistance

Ref	Remarks	€
R	Water resistant (IP66)	16,90

Length options

L(mm) Total	Remarks	€
40mm up to 60mm		0,00
from 65mm up to 100mm		20,60
length over 100 mm		Upon request

Finish options

		€
Satin Chromiun Black reader	N x x x x CSB x x x	0,00
Satin Chromiun White reader	N x x x x CSW x x x	
Polished Chromiun Black reader	N x x x x CPB x x x	0,00
Polished Chromiun White reader	N x x x x CPW x x x	
PVD Bright brass type Black reader	N x x x x PPB x x x	5,50
PVD Bright brass type White reader	N x x x x PPW x x x	
PVD Satin brass type Black reader	N x x x x PMB x x x	5,50
PVD Satin brass type White reader	N x x x x PMW x x x	
BioCoted Satin Chromiun Black reader	N x x x x BCB x x x	40,80
Satin Chromiun Black Black reader	N x x x x NEB x x x	8,65

Model NxH2x

SALTO NEO Swiss profile electronic cylinder
 Standard cylinder, one knob, one thumbturn.
 (Can be initialized in SALTO SPACE or SALTO KS)

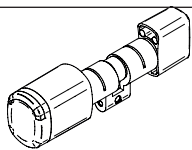

Technology	Model	Knob type	Outside length	Thumbturn	Inside length	Finish	Cams	Certification	Water resistance					
NB ¹ BLE DESFire Mifare	H2	1 Removable Knob	30	S Standard	10	CSB	H	-	For indoor use					
			35		30									
			40		35									
			45		40									
			50		45									
			55		50									
			60		60									
			65		65									
			70		G									
			75			BCB BioCote*								
			95	NEB*										
			1A (100mm.)	1C (110mm.)										
			1B (105mm.)	1D (115mm.)										
			NJ ¹ BLE HID iCLASS Seos	H2	1 Removable Knob	1C (110mm.)	R* Round			1E (120mm.)	CSW	Z	No Certification	R* For outdoor use IP66
						1D (115mm.)				1F (125mm.)				
						1E (120mm.)				1G (130mm.)				
						1F (125mm.)				1H (135mm.)				
						1G (130mm.)				1I (140mm.)				
						1H (135mm.)				1J (145mm.)				
1I (140mm.)	1K (150mm.)													
1J (145mm.)	PMW*													

Measures

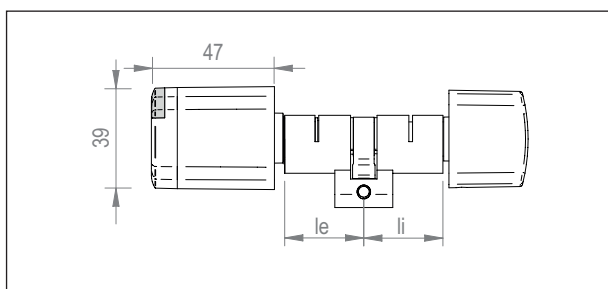

* This option has an additional price, please refer to the cylinder options chapter.
¹ Wireless BLUENet ready.
 M5 x 75mm screw included.

Profile cylinder

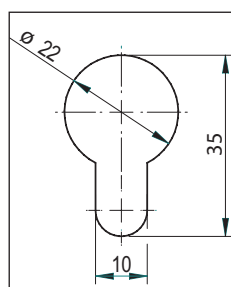

Cams

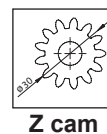
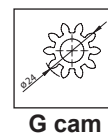
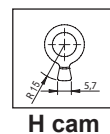

Knob Type

1

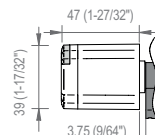

Model NxH2x	SALTO NEO Swiss profile electronic cylinder Standard cylinder, one knob, one thumbturn. (Can be initialized in SALTO SPACE or SALTO KS)
--------------------	---

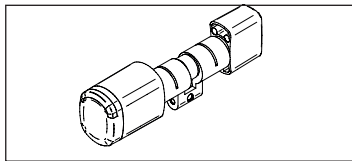

Prices - Gross prices		€
MIFARE DESFire	BLE DESFire MIFARE: Standard - standard length, standard cams, standard finish.	419,75
BLE HID iCLASS Seos	BLE HID iCLASS Seos: Standard - standard length, standard cams, standard finish.	568,30

Additional Prices - Gross prices

Water resistance

Ref	Remarks	€
R	Water resistant (IP66)	16,90

Finish options

		€
Satin Chromiun Black reader	N x x x x CSB x x x	0,00
Satin Chromiun White reader	N x x x x CSW x x x	0,00
Polished Chromiun Black reader	N x x x x CPB x x x	0,00
Polished Chromiun White reader	N x x x x CPW x x x	0,00
PVD Bright brass type Black reader	N x x x x PPB x x x	5,50
PVD Bright brass type White reader	N x x x x PPW x x x	5,50
PVD Satin brass type Black reader	N x x x x PMB x x x	5,50
PVD Satin brass type White reader	N x x x x PMW x x x	5,50
BioCoted Satin Chromiun Black reader	N x x x x BCB x x x	40,80
Satin Chromiun Black Black reader	N x x x x NEB x x x	8,65

Length options

L(mm) Total	Remarks	€
40mm up to 80mm		0,00
from 85mm up to 100mm		20,60
from 105 mm up to 120 mm		54,85
from 125 mm up to 145 mm		109,60
length over 150 mm		Upon request

Thumbturns

	€
S	0,00
R	6,90

Allen key to remove the thumbturn

Reference	Quantity	€
SP301585	1	2,40

Model NxH2xK

SALTO NEO Swiss profile electronic cylinder
AMOK cylinder, one knob, one thumbturn.
(Can be initialized in SALTO SPACE or SALTO KS)

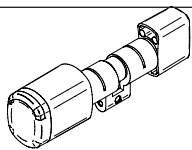

Technology	Model	Knob type	Outside length	Thumbturn	Inside length	Finish	Cams	Special function	Certification	Water resistance
NB ¹ BLE DESFire MIFARE	H2	1 Removable Knob	30	S Standard	35	CSB	H	K AMOK Function	-	-
			35							
			40							
			45							
			50							
			55							
			60							
			65							
			70							
			75							
NJ ¹ BLE HID iCLASS Seos	H2	1 Removable Knob	95	R* Round	65	NEB*	H	K AMOK Function	-	-
			1A (100mm.)							
			1B (105mm.)							
			1C (110mm.)							
			1D (115mm.)							
			1E (120mm.)							
			1F (125mm.)							
			1G (130mm.)							
			1H (135mm.)							
			1I (140mm.)							
			1J (145mm.)			70	CSW			
						75	CPW			
						95	PPW*			
						1A -100mm.	PMW*			
						1B-105mm.				

Measures

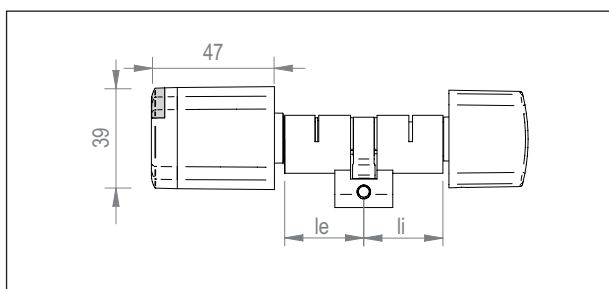

* This option has an additional price, please refer to the cylinder options chapter.
¹ Wireless BLUENet ready.
M5 x 75mm screw included.

Profile cylinder

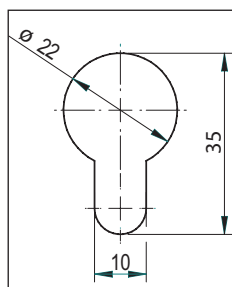

Cams

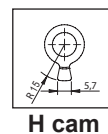

Knob Type

1

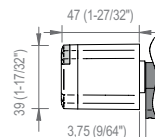

Model NxH2xK

SALTO NEO Swiss profile electronic cylinder
AMOK cylinder, one knob, one thumbturn.
(Can be initialized in SALTO SPACE or SALTO KS)

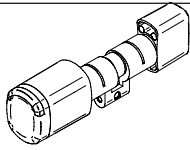

Prices - Gross prices

€



BLE DESFire MIFARE: Standard - standard length, standard cams, standard finish.

523,00



BLE HID iCLASS Seos: Standard - standard length, standard cams, standard finish.

671,45

Additional Prices - Gross prices

Water resistance

Ref	Remarks	€
R	Water resistant (IP66)	16,90

Length options

L(mm) Total	Remarks	€
40mm up to 80mm		0,00
from 85mm up to 100mm		20,60
from 105 mm up to 120 mm		54,85
from 125 mm up to 145 mm		109,60
length over 150 mm		Upon request

Finish options

		€
Satin Chromiun Black reader	N x x x x CSB x x x	0,00
Satin Chromiun White reader	N x x x x CSW x x x	0,00
Polished Chromiun Black reader	N x x x x CPB x x x	0,00
Polished Chromiun White reader	N x x x x CPW x x x	0,00
PVD Bright brass type Black reader	N x x x x PPB x x x	5,50
PVD Bright brass type White reader	N x x x x PPW x x x	5,50
PVD Satin brass type Black reader	N x x x x PMB x x x	5,50
PVD Satin brass type White reader	N x x x x PMW x x x	5,50
BioCoted Satin Chromiun Black reader	N x x x x BCB x x x	40,80
Satin Chromiun Black Black reader	N x x x x NEB x x x	8,65

Thumbturns

	€
S	0,00
R	6,90

Allen key to remove the thumbturn

Reference	Quantity	€
SP301585	1	2,40

Model NxH3x	SALTO NEO Swiss profile electronic double cylinder Standard cylinder, two knob. (Can be initialized in SALTO SPACE or SALTO KS)
--------------------	---

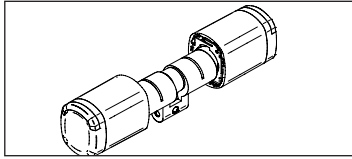

Technology	Model	Knob type	Outside length	Thumbturn	Inside length	Finish	Cams	Certification	Water resistance						
NB ¹ BLE DESFire Mifare	H3	1 Removable Knob	30	N No thumbturn	30	CSB	H	-	-						
			35		35										
			40		40										
			45		45										
			50		50										
			55		60										
			60		65										
			65		70										
			70		.										
			75			BCB BioCote*									
			95			NEB*									
			NJ ¹ BLE HID iCLASS Seos		H3	1 Removable Knob	1A (100mm.)			N No thumbturn	1C (110mm.)	CSW	G	-	No certification
							1B (105mm.)				1D (115mm.)				
							1C (110mm.)				1E (120mm.)				
							1D (115mm.)				1F (125mm.)				
							1E (120mm.)				1G (130mm.)				
							1F (125mm.)				1H (135mm.)				
							1G (130mm.)				1I (140mm.)				
							1H (135mm.)				1J (145mm.)				
1I (140mm.)	1K (150mm.)														
1J (145mm.)	PMW*														
1K (150mm.)															
						Z		R*							

Measures

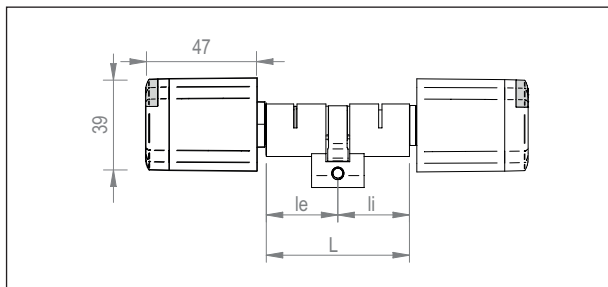

* This option has an additional price, please refer to the cylinder options chapter.
¹ Wireless BLUEnet ready.
 M5 x 75mm screw included.

Profile cylinder

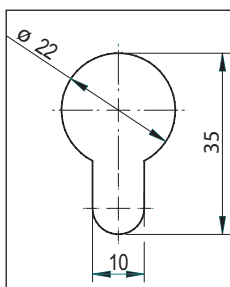

Cams

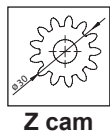
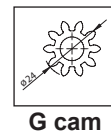
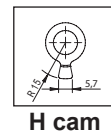

Knob Type

1

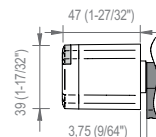

<h2 style="margin:0;">Model NxH3x</h2>	<p>SALTO NEO Swiss profile electronic double cylinder Standard cylinder, two knob. (Can be initialized in SALTO SPACE or SALTO KS)</p>

Prices - Gross prices		€
	BLE DESFire MIFARE: Standard - standard length, standard cams, standard finish.	526,40
	BLE HID iCLASS Seos: Standard - standard length, standard cams, standard finish.	674,85

Additional Prices - Gross prices

Water resistance

Ref	Remarks	€
R	Water resistant (IP66)	16,90

Length options

L(mm) Total	Remarks	€
40mm up to 80mm		0,00
from 85mm up to 100mm		20,60
from 105 mm up to 120 mm		54,85
from 125 mm up to 145 mm		109,60
length over 150 mm		Upon request

Finish options

		€
Satin Chromium Black reader	N x x x x CSB x x x	0,00
Satin Chromium White reader	N x x x x CSW x x x	
Polished Chromium Black reader	N x x x x CPB x x x	0,00
Polished Chromium White reader	N x x x x CPW x x x	
PVD Bright brass type Black reader	N x x x x PPB x x x	5,50
PVD Bright brass type White reader	N x x x x PPW x x x	
PVD Satin brass type Black reader	N x x x x PMB x x x	5,50
PVD Satin brass type White reader	N x x x x PMW x x x	
BioCoted Satin Chromium Black reader	N x x x x BCB x x x	40,80
Satin Chromium Black Black reader	N x x x x NEB x x x	8,65

Model NxS1x

SALTO NEO Scandinavian profile electronic cylinder
 Exterior cylinder, one knob, no thumbturn.
 (Can be initialized in SALTO SPACE or SALTO KS)

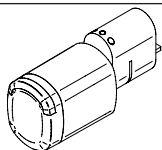

Technology	Model	Knob type	Outside length	Thumbturn	Inside length	Finish	Cams	Certification	Water resistance
NB¹ BLE DESFire Mifare	S1	1 Removable Knob	30	N No thumbturn	00	CSB	N No applicable	-	-
						CPB			
PPB*									
PMB*									
BCB BioCote*									
NEB*									
CSW									
CPW									
PPW*									
PMW*									
NJ¹ BLE HID iCLASS Seos									R* For outdoor use IP66

Measures

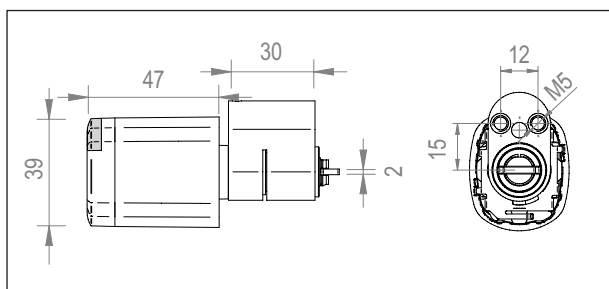

* This option has an additional price, please refer to the cylinder options chapter.
¹ Wireless BLUEnet ready.

**Requires assembly from the inside.
 Please consult SALTO for more information.**

Profile cylinder

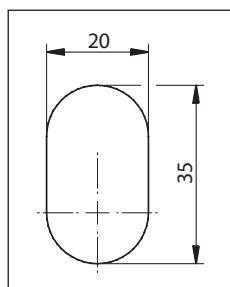

Knob Type 1

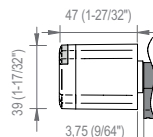

Model NxS1x

SALTO NEO Scandinavian profile electronic cylinder
 Exterior cylinder, one knob, no thumbturn.
 (Can be initialized in SALTO SPACE or SALTO KS)

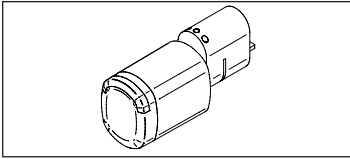

Prices - Gross prices

€



BLE DESFire MIFARE: **Standard** - standard length, standard cams, standard finish.

422,15



BLE HID iCLASS Seos: **Standard** - standard length, standard cams, standard finish.

570,50

Additional Prices - Gross prices

Water resistance

Ref	Remarks	€
R	Water resistant (IP66)	16,90

Finish options

€

Satin Chromium Black reader	N x x x x CSB x x x	0,00
Satin Chromium White reader	N x x x x CSW x x x	
Polished Chromium Black reader	N x x x x CPB x x x	0,00
Polished Chromium White reader	N x x x x CPW x x x	
PVD Bright brass type Black reader	N x x x x PPB x x x	5,50
PVD Bright brass type White reader	N x x x x PPW x x x	
PVD Satin brass type Black reader	N x x x x PMB x x x	5,50
PVD Satin brass type White reader	N x x x x PMW x x x	
BioCoted Satin Chromium Black reader	N x x x x BCB x x x	40,80
Satin Chromium Black Black reader	N x x x x NEB x x x	8,65

Model NxS2x

SALTO NEO Scandinavian profile electronic cylinder
 Interior cylinder, one knob, no thumbturn.
 (Can be initialized in SALTO SPACE or SALTO KS)

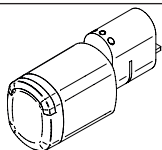

Technology	Model	Knob type	Outside length	Thumbturn	Inside length	Finish	Cams	Certification	Water resistance
NB¹ BLE DESFire Mifare	S2	1 Removable Knob	30	N No thumbturn	00	CSB	N No applicable	- No certification	- For indoor use
						CPB			
PPB*									
PMB*									
BCB BioCote*									
NEB*									
CSW									
CPW									
PPW*									
PMW*									
NJ¹ BLE HID iCLASS Seos									R* For outdoor use IP66

Measures

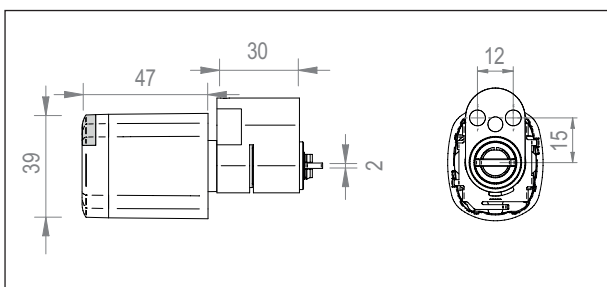

* This option has an additional price, please refer to the cylinder options chapter.
¹ Wireless BLUEnet ready.

**Requires assembly from the inside.
 Please consult SALTO for more information.**

Profile cylinder

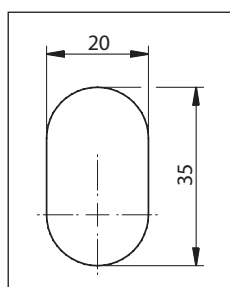

Knob Type 1

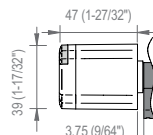

Model NxS2x

SALTO NEO Scandinavian profile electronic cylinder
Interior cylinder, one knob, no thumbturn.
(Can be initialized in SALTO SPACE or SALTO KS)

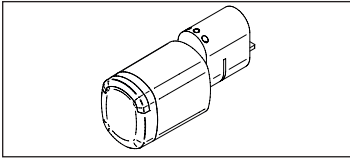

Prices - Gross prices

€



BLE DESFire MIFARE: Standard - standard length, standard cams, standard finish.

422,15



BLE HID iCLASS Seos: Standard - standard length, standard cams, standard finish.

570,50

Additional Prices - Gross prices

Water resistance

Ref	Remarks	€
R	Water resistant (IP66)	16,90

Finish options

€

Satin Chromium Black reader	N x x x x CSB x x x	0,00
Satin Chromium White reader	N x x x x CSW x x x	
Polished Chromium Black reader	N x x x x CPB x x x	0,00
Polished Chromium White reader	N x x x x CPW x x x	
PVD Bright brass type Black reader	N x x x x PPB x x x	5,50
PVD Bright brass type White reader	N x x x x PPW x x x	
PVD Satin brass type Black reader	N x x x x PMB x x x	5,50
PVD Satin brass type White reader	N x x x x PMW x x x	
BioCoted Satin Chromium Black reader	N x x x x BCB x x x	40,80
Satin Chromium Black Black reader	N x x x x NEB x x x	8,65

Model NxS3x

SALTO NEO Scandinavian profile electronic cylinder
 Security cylinder, one knob, no thumbturn.
 (Can be initialized in SALTO SPACE or SALTO KS)

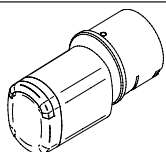

Technology	Model	Knob type	Outside length	Thumbturn	Inside length	Finish	Cams	Certification	Water resistance
NB ¹ BLE DESFire Mifare	S3	1 Removable Knob	30	N No thumbturn	00	CSB	N No applicable	-	-
						CPB			
PPB*									
PMB*									
BCB BioCote*									
NEB*									
CSW									
CPW									
PPW*									
PMW*									
NJ ¹ BLE HID iCLASS Seos									R* For outdoor use IP66

Measures

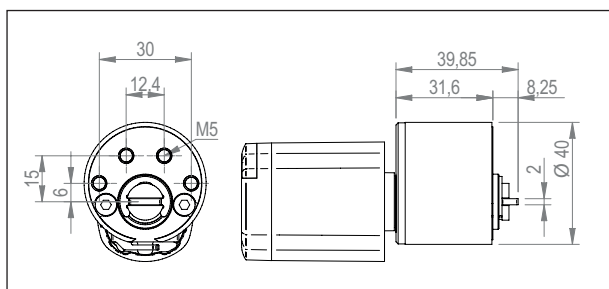

* This option has an additional price, please refer to the cylinder options chapter.
¹ Wireless BLUEnet ready.
 M5 x 45 screw included.

**Requires assembly from the inside.
 Please consult SALTO for more information.**

Profile cylinder

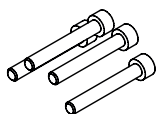
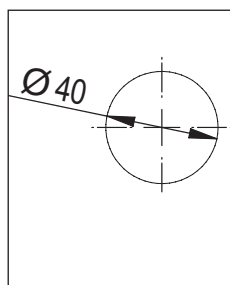

Model NxS3x

SALTO NEO Scandinavian profile electronic cylinder
Security cylinder, one knob, no thumbturn.
(Can be initialized in SALTO SPACE or SALTO KS)

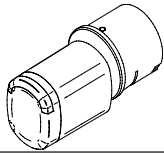

Prices - Gross prices

€



BLE DESFire MIFARE: Standard - standard length, standard cams, standard finish.

470,75



BLE HID iCLASS Seos: Standard - standard length, standard cams, standard finish.

619,20

Additional Prices - Gross prices

Water resistance

Ref	Remarks	€
R	Water resistant (IP66)	16,90

Accessories Ring - Prices - Gross prices

Reference	Finish	€
SP220874-IM	Satin Stainless Steel (US32D)	28,55
SP220874-IM for cylinder finishes CSB and CPB		28,55
SP220874-PM	PVD Satin Brass Type (US3D)	35,65
SP220874-PM for cylinder finishes PPB and PMB		35,65

Finish options

		€
Satin Chromiun Black reader	N x x x x CSB x x x	0,00
Satin Chromiun White reader	N x x x x CSW x x x	
Polished Chromiun Black reader	N x x x x CPB x x x	0,00
Polished Chromiun White reader	N x x x x CPW x x x	
PVD Bright brass type Black reader	N x x x x PPB x x x	5,50
PVD Bright brass type White reader	N x x x x PPW x x x	
PVD Satin brass type Black reader	N x x x x PMB x x x	5,50
PVD Satin brass type White reader	N x x x x PMW x x x	
BioCoted Satin Chromiun Black reader	N x x x x BCB x x x	40,80
Satin Chromiun Black Black reader	N x x x x NEB x x x	8,65



Model NxK1x

SALTO NEO RIM UK profile electronic cylinder.
Exterior cylinder, one knob, no thumbturn.
(Can be initialized in SALTO SPACE or SALTO KS)

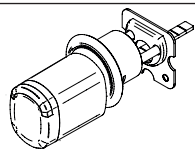

Technology	Model	Knob type	Outside length	Thumbturn	Inside length	Finish	Cams	Certification	Water resistance
NB¹ BLE DESFire Mifare	K1	1 Removable Knob	00	N No thumbturn	00	CSB	N No applicable	-	-
						CPB			
NJ¹ BLE HID iCLASS Seos	K1	1 Removable Knob	00	N No thumbturn	00	PPB*	N No applicable	G*	R*
						PMB*			
						BCB BioCote*			
						NEB*			
						CSW			
						CPW			
PPW*									
						PMW*			

Measures

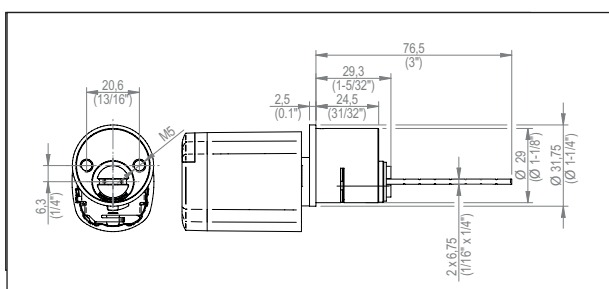

* This option has an additional price, please refer to the cylinder options chapter.
¹ Wireless BLUENet ready.

Standard ring, backplate and M5 x 45 screw included.
For SKG*** an SKG*** ring must be installed with the cylinder.

Requires assembly from the inside.
Please consult SALTO for more information.

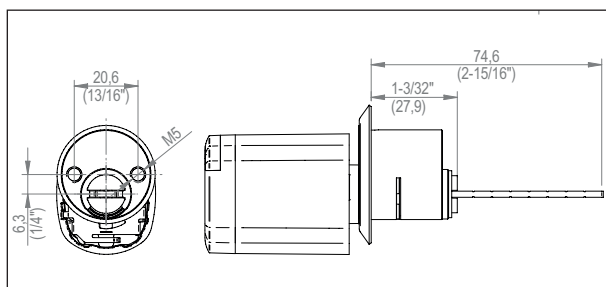
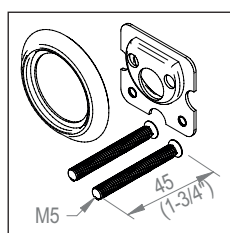

Model NxK1x

SALTO NEO RIM UK profile electronic cylinder.
Exterior cylinder, one knob, no thumbturn.
(Can be initialized in SALTO SPACE or SALTO KS)

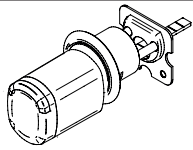

Prices - Gross prices

€



BLE DESFire MIFARE: **Standard** - standard length, standard cams, standard finish.

428,70



BLE HID iCLASS Seos: **Standard** - standard length, standard cams, standard finish.

577,25

Additional Prices - Gross prices

Water resistance

Ref	Remarks	€
R	Water resistant (IP66)	16,90

Certification

Ref	Remarks	€
G	SKG*** compliant (IP66)	33,90

Finish options

€

Satin Chromium Black reader	N x x x x CSB x x x	0,00
Satin Chromium White reader	N x x x x CSW x x x	
Polished Chromium Black reader	N x x x x CPB x x x	0,00
Polished Chromium White reader	N x x x x CPW x x x	
PVD Bright brass type Black reader	N x x x x PPB x x x	5,50
PVD Bright brass type White reader	N x x x x PPW x x x	
PVD Satin brass type Black reader	N x x x x PMB x x x	5,50
PVD Satin brass type White reader	N x x x x PMW x x x	
BioCoted Satin Chromium Black reader	N x x x x BCB x x x	40,80
Satin Chromium Black Black reader	N x x x x NEB x x x	8,65

Model NxB1x

SALTO NEO RIM USA profile electronic cylinder.
Exterior cylinder, one knob, no thumbturn.
(Can be initialized in SALTO SPACE or SALTO KS)

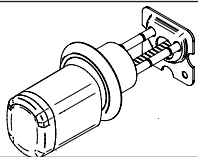

Technology	Model	Knob type	Outside length	Thumbturn	Inside length	Finish	Cams	Certification	Water resistance	
NB¹ BLE DESFire Mifare	B1	1 Removable Knob	00	N No thumbturn	00	CSB	N No applicable	-	-	
						CPB				
NJ¹ BLE HID iCLASS Seos	B1	1 Removable Knob	00	N No thumbturn	00	PMB*	N No applicable	-	-	
						BCB BioCote*				
						NEB*				
						CSW				
						CPW				
						PPW*				
PMW*										
									For indoor use	
										R* For outdoor use IP66

Measures

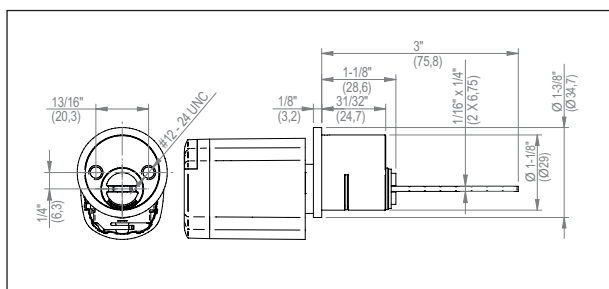

* This option has an additional price, please refer to the cylinder options chapter.
¹ Wireless BLUENet ready.

Standard ring, backplate and 12-24UNC screw included.

Requires assembly from the inside.
Please consult SALTO for more information.

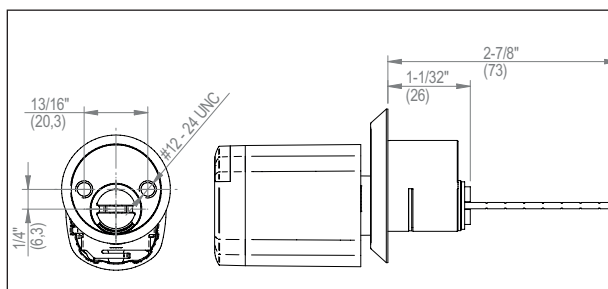
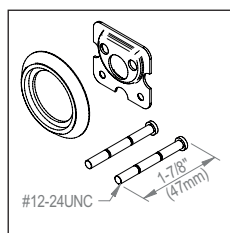

Model NxB1x

SALTO NEO RIM USA profile electronic cylinder.
 Exterior cylinder, one knob, no thumbturn.
 (Can be initialized in SALTO SPACE or SALTO KS)

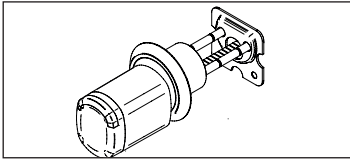

Prices - Gross prices

€



BLE DESFire MIFARE: **Standard** - standard length, standard cams, standard finish.

439,80



BLE HID iCLASS Seos: **Standard** - standard length, standard cams, standard finish.

588,30

Additional Prices - Gross prices

Water resistance

Ref	Remarks	€
R	Water resistant (IP66)	16,90

Finish options

€

Satin Chromium Black reader	N x x x x CSB x x x	0,00
Satin Chromium White reader	N x x x x CSW x x x	
Polished Chromium Black reader	N x x x x CPB x x x	0,00
Polished Chromium White reader	N x x x x CPW x x x	
PVD Bright brass type Black reader	N x x x x PPB x x x	5,50
PVD Bright brass type White reader	N x x x x PPW x x x	
PVD Satin brass type Black reader	N x x x x PMB x x x	5,50
PVD Satin brass type White reader	N x x x x PMW x x x	
BioCoted Satin Chromium Black reader	N x x x x BCB x x x	40,80
Satin Chromium Black Black reader	N x x x x NEB x x x	8,65

Model NxB2x

SALTO NEO RIM USA profile electronic cylinder.
 For Schlage® B-series deadbolt. Exterior cylinder, one knob, no thumbturn.
 (Can be initialized in SALTO SPACE or SALTO KS)

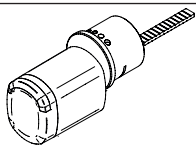

Technology	Model	Knob type	Outside length	Thumbturn	Inside length	Finish	Cams	Certification	Water resistance
NB¹ BLE DESFire Mifare	B2	1 Removable Knob	00	N No thumbturn	00	CSB	N No applicable	- No certification	- For indoor use
						CPB			
PPB*									
PMB*									
BCB BioCote*									
NEB*									
CSW									
CPW									
PPW*									
PMW*									
NJ¹ BLE HID iCLASS Seos									R* For outdoor use IP66

Measures

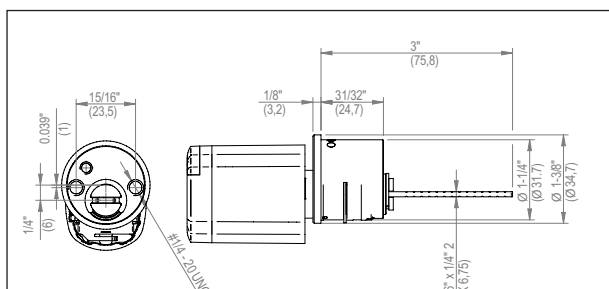

* This option has an additional price, please refer to the cylinder options chapter.
¹ Wireless BLUENet ready.

**Requires assembly from the inside.
 Please consult SALTO for more information.**

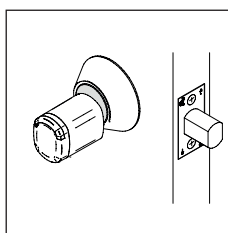

Model NxB2x

SALTO NEO RIM USA profile electronic cylinder.
For Schlage® B-series deadbolt. Exterior cylinder, one knob, no thumbturn.
(Can be initialized in SALTO SPACE or SALTO KS)

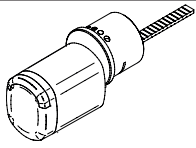

Prices - Gross prices

€



BLE DESFire MIFARE: Standard - standard length, standard cams, standard finish.

439,80



BLE HID iCLASS Seos: Standard - standard length, standard cams, standard finish.

588,30

Additional Prices - Gross prices

Water resistance

Ref	Remarks	€
R	Water resistant (IP66)	16,90

Finish options

€

Satin Chromium Black reader	N x x x x CSB x x x	0,00
Satin Chromium White reader	N x x x x CSW x x x	
Polished Chromium Black reader	N x x x x CPB x x x	0,00
Polished Chromium White reader	N x x x x CPW x x x	
PVD Bright brass type Black reader	N x x x x PPB x x x	5,50
PVD Bright brass type White reader	N x x x x PPW x x x	
PVD Satin brass type Black reader	N x x x x PMB x x x	5,50
PVD Satin brass type White reader	N x x x x PMW x x x	
BioCoted Satin Chromium Black reader	N x x x x BCB x x x	40,80
Satin Chromium Black Black reader	N x x x x NEB x x x	8,65

Model Nx B3x51

SALTO NEO Heavy duty deadbolt electronic cylinder.
To be used in combination with SALTO deadbolt LD51 or LD71series
(Can be initialized in SALTO SPACE or SALTO KS)

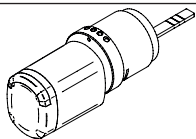

Technology	Model	Knob type	Function	Door thickness	Inside length	Finish	Cams	Certification	Water resistance
NB ¹ BLE DESFire Mifare	B3	1 Removable Knob	51	N No applicable	00	CSB	N No applicable	-	- For indoor use
NJ ¹ BLE HID iCLASS Seos						CSW			R* For outdoor use IP66

Measures

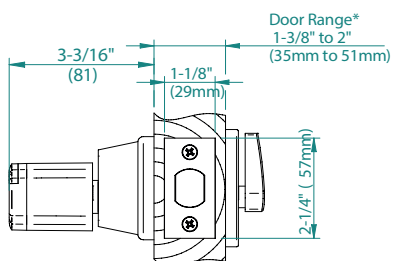

Deadbolt meet A156.36 Grade 1 requirements

* This option has an additional price, please refer to the cylinder options chapter.

¹ Wireless BLUEnet ready.

SALTO NEO B3 cylinder can not be sold separately to the SALTO LD series deadbolt

Function	Illustration	Operations	ANSI number	Cylinder	Deadbolt
51 Single cylinder		Deadbolt operated by card form outside and by thumbturn from the inside. Latch projected automatically.	E2151	NiB3151N00CSxN 	LD51C70CS
71 classroom		Deadbolt operated by card form outside. Thumbturn retracts deadbolt but does not project it.	E2171	NiB3151N00CSxN 	LD71C70CS

Model Nx B3x51

SALTO NEO Heavy duty deadbolt electronic cylinder.
To be used in combination with SALTO deadbolt LD51 or LD71series
(Can be initialized in SALTO SPACE or SALTO KS)

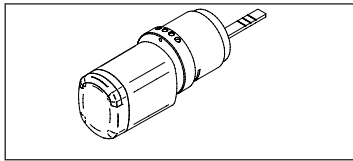

Prices - Gross prices		€
MIFARE DESFire	BLE DESFire MIFARE: Standard - standard length, standard cams, standard finish.	439,80
BLE HID iCLASS Seos	BLE HID iCLASS Seos: Standard - standard length, standard cams, standard finish.	588,30

Additional Prices - Gross prices

Water resistance

Ref	Remarks	€
R	Water resistant (IP66)	16,90

SALTO Deadbolt

Function	Illustration	Operations	Reference			€
			Product	Backset	Finish	
51 Single cylinder		Deadbolt operated by card form outside and by thumbturn from the inside Latch projected automatically	LD51C	70 70mm (2-3/4")	CS Satin chromium	114,60
				60 60mm (2-3/8")		
71 classroom		Deadbolt operated by card form outside. Thumbturn retracts deadbolt but does not project it	LD71C	70 70mm (2-3/4")	CS Satin chromium	114,60
				60 60mm (2-3/8")		

Model NxB3x41

SALTO NEO Heavy duty deadbolt electronic double cylinder.
To be used in combination with SALTO deadbolt LD41 series
(Can be initialized in SALTO SPACE or SALTO KS)

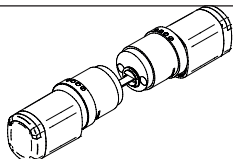

Technology	Model	Knob type	Function	Door thickness	Inside length	Finish	Cams	Certification	Water resistance
NB ¹ BLE DESFire Mifare	B3	1 Removable Knob	41	N No thumbturn	00	CSB	N No applicable	- No certification	- For indoor use
NJ ¹ BLE HID iCLASS Seos						CSW			R* For outdoor use IP66

Measures

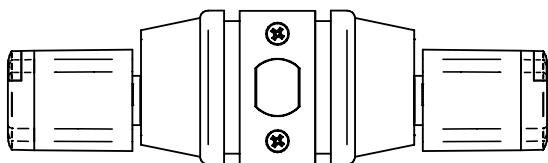

Deadbolt meet A156.36 Grade 1 requirements

* This option has an additional price, please refer to the cylinder options chapter.

¹ Wireless BLUEnet ready.



SALTO NEO B3 cylinder can not be sold separately to the SALTO LD series deadbolt

Function	Illustration	Operations	ANSI number	Cylinder	Deadbolt
41 Double cylinder		Deadbolt operated by card from either side	E2141	NiB3141N00CSxN 	LD41C70CS

Model Nx B3x41

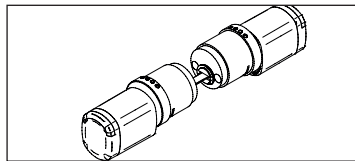
SALTO NEO Heavy duty deadbolt electronic double cylinder.
To be used in combination with SALTO deadbolt LD41 series
(Can be initialized in SALTO SPACE or SALTO KS)



Prices - Gross prices		€
	BLE DESFire MIFARE: Standard - standard length, standard cams, standard finish.	864,40
	BLE HID iCLASS Seos: Standard - standard length, standard cams, standard finish.	1012,85

Additional Prices - Gross prices

Water resistance

Ref	Remarks	€
R	Water resistant (IP66)	16,90

SALTO Deadbolt

Function	Illustration	Operations	Reference			€
			Product	Backset	Finish	
41 Double cylinder		Deadbolt operated by card from either side	LD41C	70 70mm (2-3/4")	CS Satin chromium	161,85
				60 60mm (2-3/8")		

Model NxB4x

SALTO NEO RIM USA profile electronic cylinder.
For Hager deadbolt. Exterior cylinder, one knob, no thumbturn.
(Can be initialized in SALTO SPACE or SALTO KS)

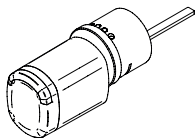

Technology	Model	Knob type	Outside length	Thumbturn	Inside length	Finish	Cams	Certification	Water resistance
NB¹ BLE DESFire Mifare	B4	1 Removable Knob	51	N No thumbturn	00	CSB	N No applicable	-	-
						CPB			
PPB*									
PMB*									
BCB BioCote*									
NEB*									
CSW									
CPW									
PPW*									
PMW*									
NJ¹ BLE HID iCLASS Seos									R* For outdoor use IP66

Measures

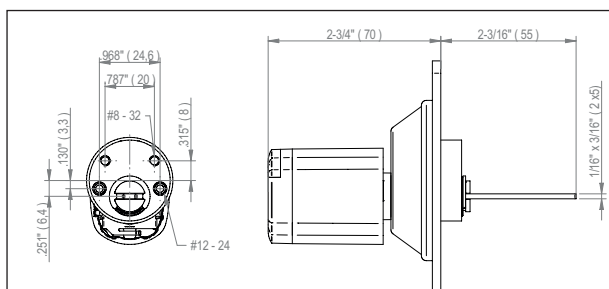

* This option has an additional price, please refer to the cylinder options chapter.
¹ Wireless BLUEnet ready.

Requires assembly from the inside.
Please consult SALTO for more information.

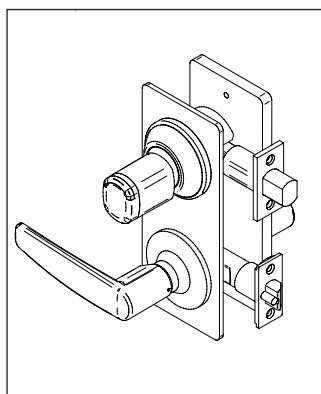

Model NxB4x

SALTO NEO RIM USA profile electronic cylinder.
For Hager deadbolt. Exterior cylinder, one knob, no thumbturn.
(Can be initialized in SALTO SPACE or SALTO KS)

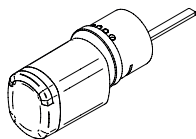

Prices - Gross prices

€



BLE DESFire MIFARE: Standard - standard length, standard cams, standard finish.

439,80



BLE HID iCLASS Seos: Standard - standard length, standard cams, standard finish.

588,30

Additional Prices - Gross prices

Water resistance

Ref	Remarks	€
R	Water resistant (IP66)	16,90

Finish options

€

Satin Chromium Black reader	N x x x x CSB x x x	0,00
Satin Chromium White reader	N x x x x CSW x x x	
Polished Chromium Black reader	N x x x x CPB x x x	0,00
Polished Chromium White reader	N x x x x CPW x x x	
PVD Bright brass type Black reader	N x x x x PPB x x x	5,50
PVD Bright brass type White reader	N x x x x PPW x x x	
PVD Satin brass type Black reader	N x x x x PMB x x x	5,50
PVD Satin brass type White reader	N x x x x PMW x x x	
BioCoted Satin Chromium Black reader	N x x x x BCB x x x	40,80
Satin Chromium Black Black reader	N x x x x NEB x x x	8,65

Model NxM1x

SALTO NEO Mortise profile electronic cylinder
Exterior cylinder, one knob, no thumbturn.
(Can be initialized in SALTO SPACE or SALTO KS)

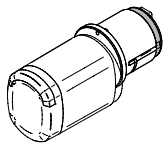

Technology	Model	Knob type	Outside length	Thumbturn	Inside length	Finish	Cams	Certification	Water resistance
NB ¹ BLE DESFire Mifare	M1	Removable Knob	32 (1-1/4")	N No thumbturn	00	CSB	N No applicable	-	-
			35 (1-3/8")			CPB			
38 (1-1/2")			PPB*						
41 (1-5/8")			PMB*						
44 (1-3/4")			BCB BioCote*						
50 (2")			NEB*						
NJ ¹ BLE HID iCLASS Seos			CSW						
			CPW						
			PPW*						
			PMW*						
								- For indoor use	
								R* For outdoor use IP66	

Measures

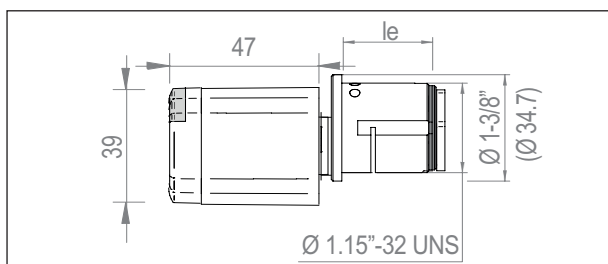

* This option has an additional price, please refer to the cylinder options chapter.
¹ Wireless BLUENet ready.

**Requires assembly from the inside.
Please consult SALTO for more information.**

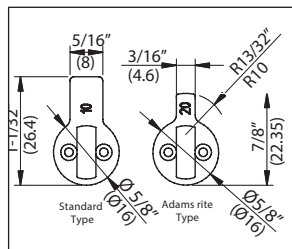

Mortise cylinders are supplied with standard cam. Adams Rite type also included

The following cams are also compatible to mount on SALTO NEO mortise cylinder MEDECO, YALE, MARKS ILCO (not sold by SALTO).

Length options Additional Prices - Gross prices

SERIE	le (mm)	le (inches)	Remarks	€
NxM1032	32	1-1/4"		0,00
NxM1035	35	1-3/8"		
NxM1038	38	1-1/2"		20,90
NxM1041	41	1-5/8"		
NxM1044	44	1-3/4"		34,75
NxM1050	50	2"		

Installation tool for mortise cylinders





Reference	€
SP220412-N	1,30

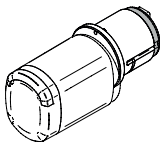

Spring included.

Model NxM1x	SALTO NEO Mortise profile electronic cylinder Exterior cylinder, one knob, no thumbturn. (Can be initialized in SALTO SPACE or SALTO KS)
	

Prices - Gross prices	€		
 <table border="1" style="width:100%; border-collapse: collapse;"> <tr> <td style="width:75%;">BLE DESFire MIFARE: Standard - standard length, standard cams, standard finish.</td> <td style="width:25%; text-align: center;">428,70</td> </tr> </table>	BLE DESFire MIFARE: Standard - standard length, standard cams, standard finish.	428,70	
BLE DESFire MIFARE: Standard - standard length, standard cams, standard finish.	428,70		
 <table border="1" style="width:100%; border-collapse: collapse;"> <tr> <td style="width:75%;">BLE HID iCLASS Seos: Standard - standard length, standard cams, standard finish.</td> <td style="width:25%; text-align: center;">577,25</td> </tr> </table>	BLE HID iCLASS Seos: Standard - standard length, standard cams, standard finish.	577,25	
BLE HID iCLASS Seos: Standard - standard length, standard cams, standard finish.	577,25		

Additional Prices - Gross prices

Water resistance

Ref	Remarks	€
R	Water resistant (IP66)	16,90

Finish options

Finish options	€
Satin Chromiun - Black reader	0,00
Satin Chromiun - White reader	0,00
Polished Chromiun - Black reader	0,00
Polished Chromiun - White reader	0,00
PVD Bright brass type - Black reader	5,50
PVD Bright brass type - White reader	5,50
PVD Satin brass type - Black reader	5,50
PVD Satin brass type - White reader	5,50
BioCoted Satin Chromiun - Black reader	40,80
Satin Chromiun Black - Black reader	8,65

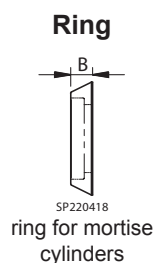

Reference	B	Finish	€
SP220418.38-IM	3/8" (9.5 mm)	Satin Stainless Steel (US32D)	14,30
SP220418.12-IM	1/2" (12.7 mm)	Satin Stainless Steel (US32D)	14,30
SP220418.xx-IM for cylinder finishes CSB and CPB			
SP220418.38-PM	3/8" (9.5 mm)	PVD Satin Brass Type (US3D)	20,25
SP220418.12-PM	1/2" (12.7 mm)	PVD Satin Brass Type (US3D)	20,25
SP220418.xx-PM for cylinder finishes PPB and PMB			

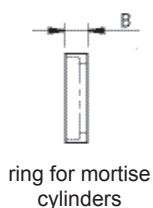

Reference	B	Finish	€
SP220646-IM	3/8" (9.5 mm)	Satin Stainless Steel (US32D)	14,30
SP220646.12-IM	1/2" (12.7 mm)	Satin Stainless Steel (US32D)	14,30
SP220646.xx-IM for cylinder finishes CSB and CPB			
SP220646-PM	3/8" (9.5 mm)	PVD Satin Brass Type (US3D)	20,25
SP220646.12-PM	1/2" (12.7 mm)	PVD Satin Brass Type (US3D)	20,25
SP220646.xx-PM for cylinder finishes PPB and PMB			

Model NxA1x

SALTO NEO Australian oval profile electronic cylinder
 Exterior cylinder, one knob, no thumbturn.
 (Can be initialized in SALTO SPACE or SALTO KS)

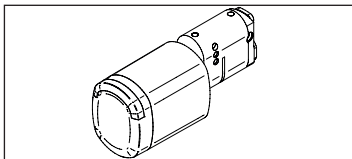

Technology	Model	Knob type	Outside length	Thumbturn	Inside length	Finish	Cams	Certification	Water resistance
NB¹ BLE DESFire Mifare	A1	1 Removable Knob	00	N No thumbturn	00	CSB	N No applicable	-	-
						CPB			
NJ¹ BLE HID iCLASS Seos	A1	1 Removable Knob	00	N No thumbturn	00	PPB*	N No applicable	-	-
						PMB*			
						BCB BioCote*			
						NEB*			
						CSW			
						CPW			
PPW*									
						PMW*			R* For outdoor use IP66

Measures

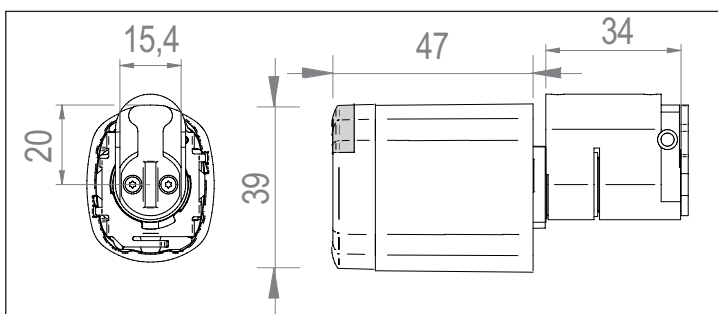

* This option has an additional price, please refer to the cylinder options chapter.
¹ Wireless BLUENet ready.

**Requires assembly from the inside.
 Please consult SALTO for more information.**

Profile cylinder

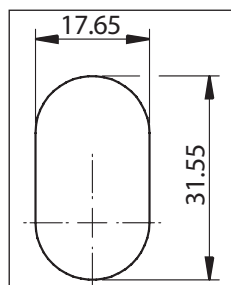

Cams
 Standard Cam

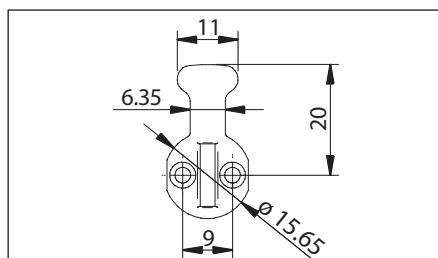

Model NxA1x

SALTO NEO Australian oval profile electronic cylinder
Exterior cylinder, one knob, no thumbturn.
(Can be initialized in SALTO SPACE or SALTO KS)

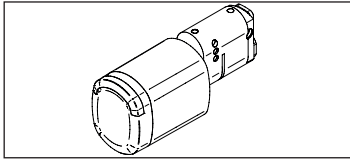

Prices - Gross prices

€



BLE DESFire MIFARE: Standard - standard length, standard cams, standard finish.

422,15



BLE HID iCLASS Seos: Standard - standard length, standard cams, standard finish.

570,50

Additional Prices - Gross prices

Water resistance

Ref	Remarks	€
R	Water resistant (IP66)	16,90

Finish options

€

Satin Chromium Black reader	N x x x x CSB x x x	0,00
Satin Chromium White reader	N x x x x CSW x x x	
Polished Chromium Black reader	N x x x x CPB x x x	0,00
Polished Chromium White reader	N x x x x CPW x x x	
PVD Bright brass type Black reader	N x x x x PPB x x x	5,50
PVD Bright brass type White reader	N x x x x PPW x x x	
PVD Satin brass type Black reader	N x x x x PMB x x x	5,50
PVD Satin brass type White reader	N x x x x PMW x x x	
BioCoted Satin Chromium Black reader	N x x x x BCB x x x	40,80
Satin Chromium Black Black reader	N x x x x NEB x x x	8,65

Model NxJ1x

SALTO NEO Japanese round cylinder
Exterior cylinder, one knob, no thumbturn.
(Can be initialized in SALTO SPACE or SALTO KS)

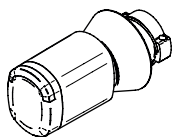

Technology	Model	Knob type	Outside length	Thumbturn	Inside length	Finish	Cams	Certification	Water resistance
NB¹ BLE DESFire Mifare	J1	1 Removable Knob	00	N No thumbturn	00	CSB	N No applicable	-	-
						CPB			
PPB*									
PMB*									
BCB BioCote*									
NEB*									
CSW									
CPW									
PPW*									
PMW*									
NJ¹ BLE HID iCLASS Seos									R* For outdoor use IP66

Measures

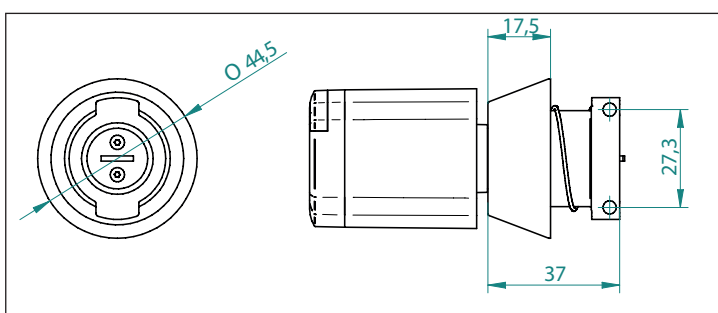

* This option has an additional price, please refer to the cylinder options chapter.
¹ Wireless BLUENet ready.

Profile cylinder

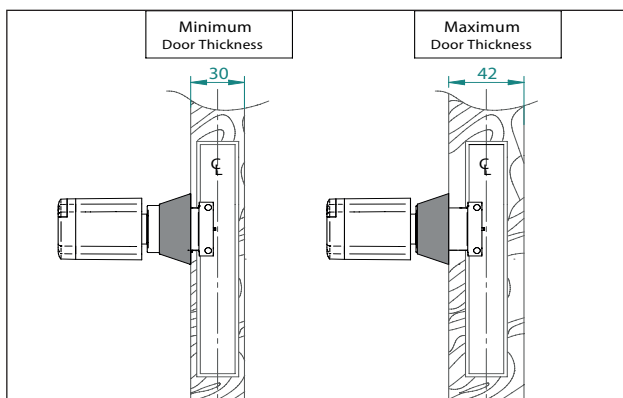
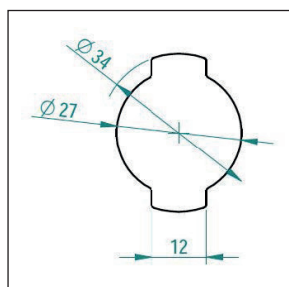

Model NxJ1x

SALTO NEO Japanese round cylinder
 Exterior cylinder, one knob, no thumbturn.
 (Can be initialized in SALTO SPACE or SALTO KS)

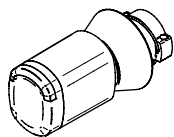

Prices - Gross prices

€



BLE DESFire MIFARE: **Standard** - standard length, standard cams, standard finish.

439,80



BLE HID iCLASS Seos: **Standard** - standard length, standard cams, standard finish.

588,30

Additional Prices - Gross prices









Water resistance

Ref	Remarks	€
R	Water resistant (IP66)	16,90

Finish options

€

Satin Chromium Black reader	N x x x x CSB x x x	0,00
Satin Chromium White reader	N x x x x CSW x x x	
Polished Chromium Black reader	N x x x x CPB x x x	0,00
Polished Chromium White reader	N x x x x CPW x x x	
PVD Bright brass type Black reader	N x x x x PPB x x x	5,50
PVD Bright brass type White reader	N x x x x PPW x x x	
PVD Satin brass type Black reader	N x x x x PMB x x x	5,50
PVD Satin brass type White reader	N x x x x PMW x x x	
BioCoted Satin Chromium Black reader	N x x x x BCB x x x	40,80
Satin Chromium Black Black reader	N x x x x NEB x x x	8,65

Product description	Product reference	€
Stainless steel finishes		
Satin Chromiun Black reader 	N X X X X X X X CSB X X	0,00
Satin Chromiun White reader 	N X X X X X X X CSW X X	
Polished Chromiun Black reader 	N X X X X X X X CPB X X	0,00
Polished Chromiun White reader 	N X X X X X X X CPW X X	
Brass finishes		
PVD Bright brass type Black reader 	N X X X X X X X PPB X X	5,50
PVD Bright brass type White reader 	N X X X X X X X PPW X X	
PVD Satin brass type Black reader 	N X X X X X X X PMB X X	5,50
PVD Satin brass type White reader 	N X X X X X X X PMW X X	
BioCoted Satin Chromiun Just the Reader and the knob are BioCoted, not the body either the Cam 	N X X X X X X X BCB X X	40,80
Black Satin Chromiun Black reader 	N X X X X X X X NEB X X	8,65

Example of price calculation for finishes other than Satin Stainless (IM), which is the standard used in our price list.

Required is NBE2030S30PPBD.	€
NBE2030S30CSBD	404,40
Additional price for PVD Bright brass type finish	5,50
Total Price:	409,90

 Please note that brass finishes may become discoloured over time due to their exposure to environmental conditions such as humidity, pollution and salt air. Rings and keys can also scratch the brass lacquer finish and once this has started to occur, discolouration will likely begin.

Model SP225542	SALTO removable knob cylinder tool.
-----------------------	-------------------------------------

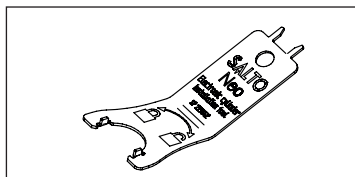

Prices - Gross prices		€
Description	Reference	
SALTO NEO cylinder removable knob tool	S P 2 2 5 5 4 2	18,05

Model SP01926-5	SALTO alkaline batteries LR1 for SALTO NEO cylinders.
------------------------	---

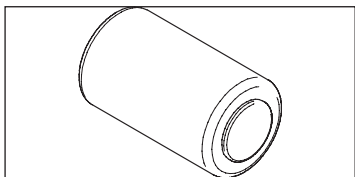

Prices - Gross prices		€
Description	Reference	
SALTO alkaline batteries LR1 for SALTO NEO cylinders. 5 Packs of 4 batteries	S P 0 1 9 2 6 - 5	36,85

Model SP201587	SALTO euro cylinder measuring key (PZ).
-----------------------	---

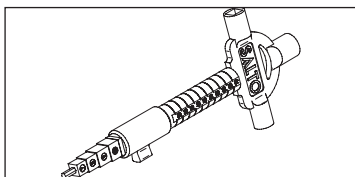

Prices - Gross prices		€
Description	Reference	
Euro cylinder measuring key (PZ)	S P 2 0 1 5 8 7	19,40

Model SP301585	SALTO 2,5mm Allen key for SALTO NEO cylinders with thumbturn. Permits to remove the thumbturn
-----------------------	--

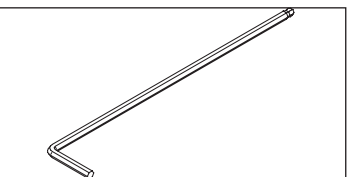

Prices - Gross prices		€
Description	Reference	
SALTO 2,5mm Allen key for SALTO NEO cylinders with thumbturn	S P 3 0 1 5 8 5	2,40

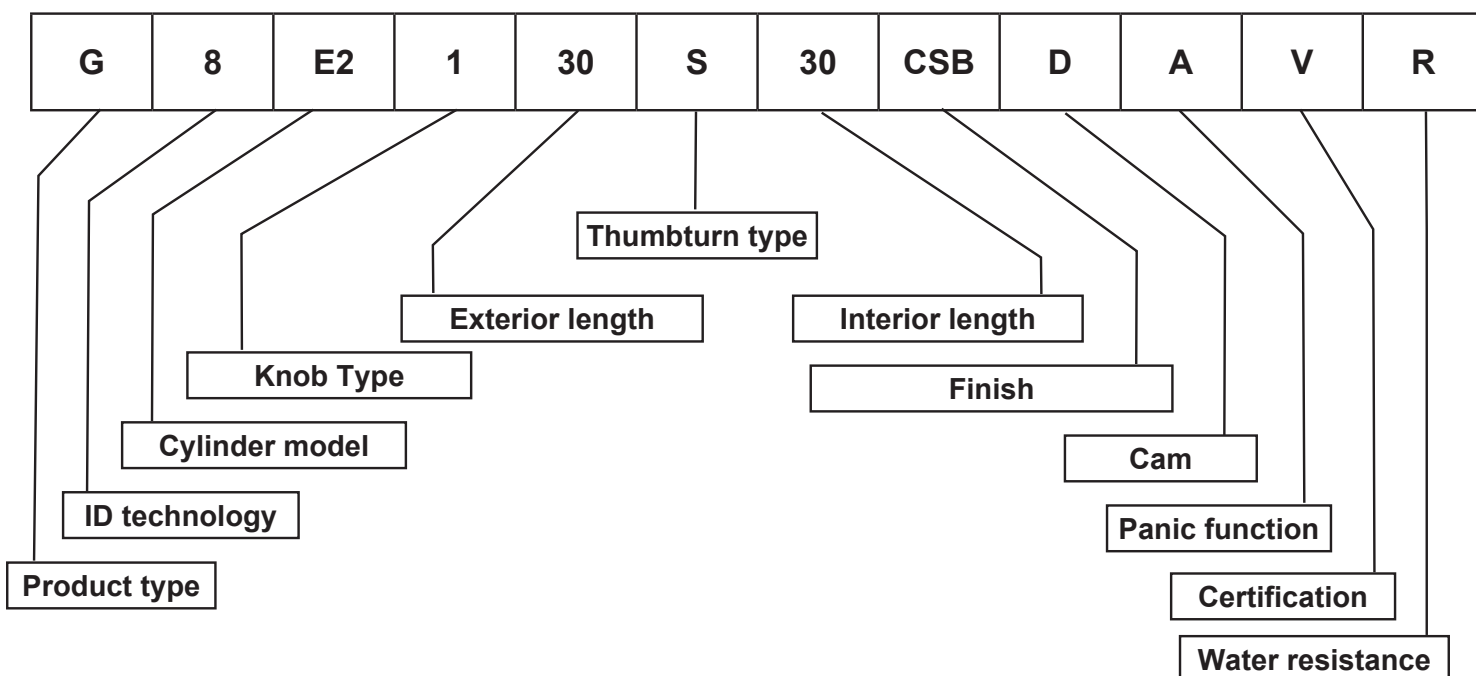
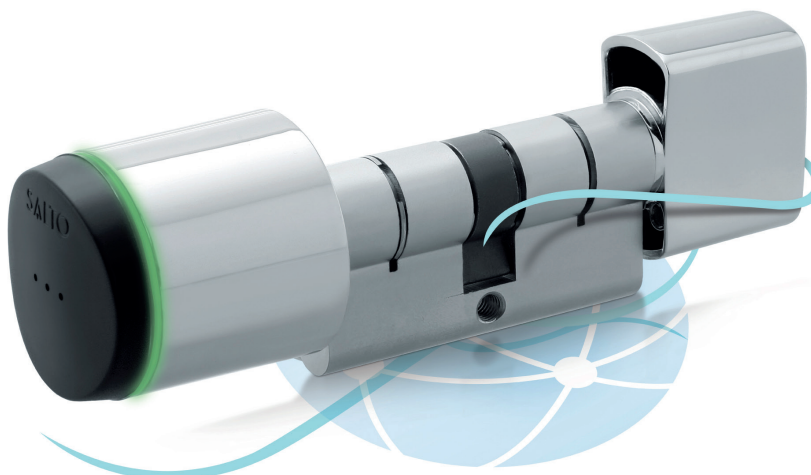

Product type:

G = SALTO GEO Electronic cylinder

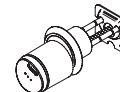
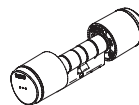
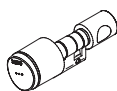

ID technology

RFID

- 8 = Contactless LEGIC advant
- 9 = Contactless Mifare/DESFire
- H = Contactless HID iCLASS

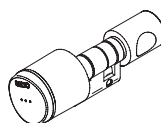

MIFARE DESFire technologies can be set up as selfprogrammable, ROM or RW

Model

- E1** = Half Euro profile cylinder.
- E2** = Euro profile cylinder with thumbturn.
- E3** = Euro profile double cylinder, double knob.
- E9** = Electronic cylinder for swing handles.
- CL** = Cam lock cylinder.
- U1** = Half UK profile cylinder.
- U2** = UK profile cylinder with thumbturn.
- U3** = UK profile double cylinder, double knob.
- S1** = Standard Scandinavian external cylinder.
- S2** = Standard Scandinavian internal cylinder.
- S3** = Scandinavian Security external cylinder.
- K1** = UK profile Rim cylinder.
- B1** = USA profile Rim cylinder.
- B2** = Schlage® B-series with deadbolt Rim cylinder.
- B3** = Heavy duty deadbolt.
- M1** = Mortice USA profile cylinder.
- A1** = Australian oval profile cylinder.
- H1** = Half Swis profile cylinder.
- H2** = Swiss profile cylinder with thumbturn.
- H3** = Swiss profile double cylinder, double knob
- P2** = Cylinder Padlock.

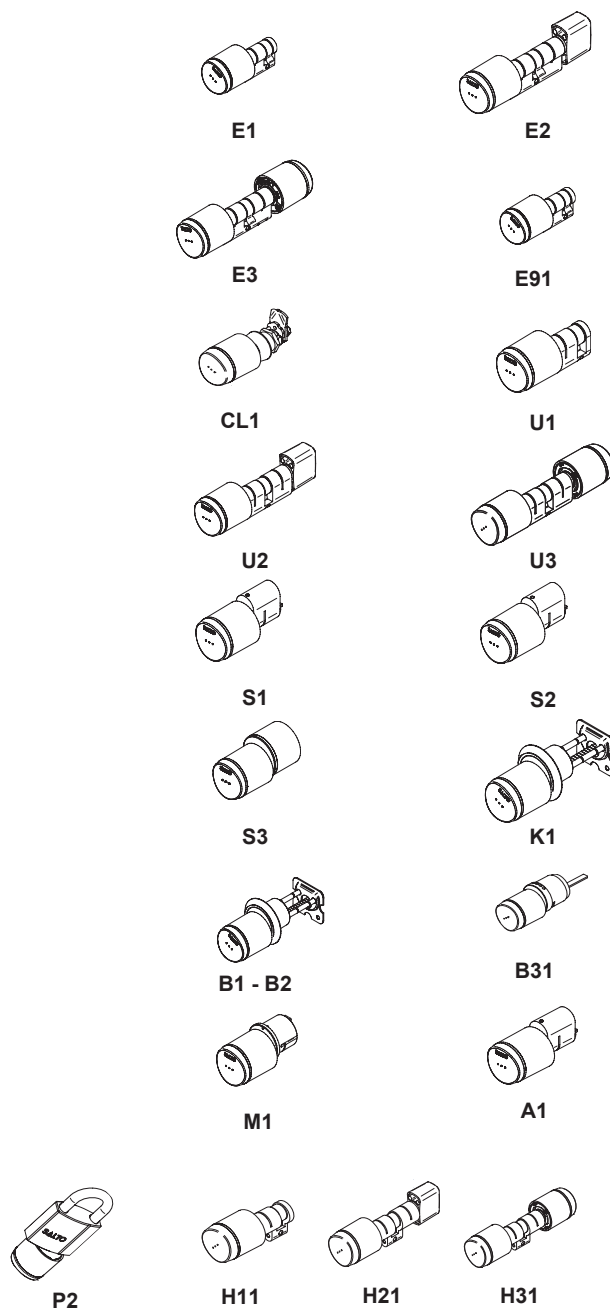

Knob type

- 1** = Standard removable knob, the battery can be changed .
- 2** = Removable knob with plug of 5mm. the battery can be changed.
- 3** = Removable knob with plug of 10mm. the battery can be changed.

Knob type 1 removable knob

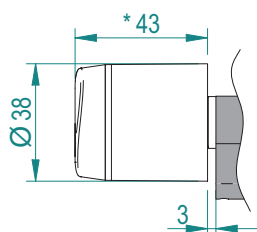

Knob type 2 removable knob plus plug of 5mm

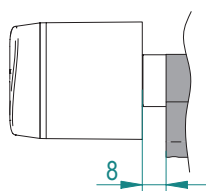

Knob type 3 removable knob plus plug of 10mm

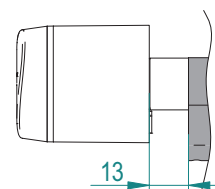

When used with double reader units, the knob type applies only to the external knob. Internal knob will always be "1"

Cylinder length

(le) Outside length
(li) Inside length

le (exterior length)

from 30mm. up to 100mm.

30 = 30mm.	1A = 100mm.
35 = 35mm.	1B = 105mm.
40 = 40mm.	1C = 110mm.
45 = 45mm.	1D = 115mm.
50 = 50mm.	1E = 120mm.
55 = 55mm.	1F = 125mm.
60 = 60mm.	1G = 130mm.
65 = 65mm.	1H = 135mm.
70 = 70mm.	1I = 140mm.
75 = 75mm.	1J = 145mm.
80 = 80mm.	1K = 150mm.
85 = 85mm.	1L = 155mm.
90 = 90mm.	1M = 160mm.
95 = 95mm.	1N = 165mm.

li (interior length)

from 10mm. up to 100mm.

00 = not applicable.
(for half cylinders, Rim cylinders or Mortise cylinders)

10 = 10mm.	90 = 90mm.
15 = 15mm.	95 = 95mm.
20 = 20mm.	1A = 100mm.
25 = 25mm.	1B = 105mm.
30 = 30mm.	1C = 110mm.
35 = 35mm.	1D = 115mm.
40 = 40mm.	1E = 120mm.
45 = 45mm.	1F = 125mm.
50 = 50mm.	1G = 130mm.
55 = 55mm.	1H = 135mm.
60 = 60mm.	1I = 140mm.
65 = 65mm.	1J = 145mm.
70 = 70mm.	1K = 150mm.
75 = 75mm.	1L = 155mm.
80 = 80mm.	1M = 160mm.
85 = 85mm.	1N = 165mm.

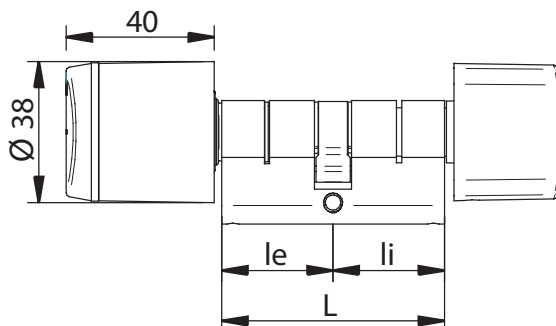

le for mortise (exterior length)

from 29mm. up to 50mm.

29 = 29mm.
32 = 32mm.
35 = 35mm.
38 = 38mm.
41 = 41mm.
44 = 44mm.
50 = 50mm.

* Some distance can have an additional price consult the cylinder section.

Depending on the total length, the cylinder model can change

Thumbturn design

S = Standard.

R = Round.

N = No thumbturn.

(for half cylinders, Rim cylinders or Mortise cylinders)

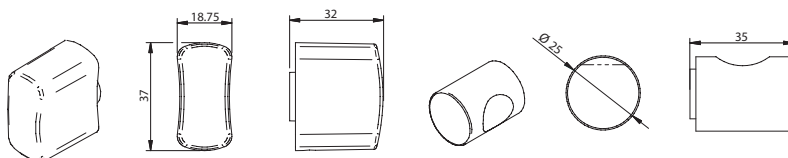

S thumbturn

R thumbturn

Knob finishes

CSB =

Satin Chrome
Black reader

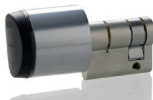

PPB =

Polished bright
brass type (PVD)
Black reader



BCB =

BioCoted
Satin Chrome
Black reader

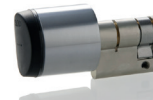

CPB =

Polished Chrome
Black reader

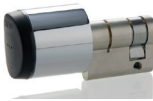

PMB =

Satin brass type
(PVD)
Black reader



NEB =

Satin Chrome
Black
Black reader



CSW =

Satin Chrome
White reader



PPW =

Polished bright
brass type (PVD)
White reader

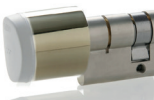

NEW =

Satin Chrome
Black
White reader



CPW =

Polished Chrome
White reader



PMW =

Satin brass type
(PVD)
White reader



Please note that brass and BiCote finishes may become discoloured over time due to their exposure to environmental conditions such as humidity, pollution and salt air.

Rings and keys can also scratch the brass lacquer finish and once this has started to occur, discolouration will likely begin.

Cams

- D = DIN cam for Euro profile (15mm) **standard**.
- K = UK oval cam 14.3mm.
- M = DIN cam 13.2 mm for metal doors **(for Spanish metal doors)**.
- N = Not applicable **(for Rim cylinders or Mortise cylinders)**.
- H = Swiss 15mm **(for Swiss cylinders)**.
- G = Cog wheel cam 10 teeth.
- Z = Cog wheel cam 13 teeth.

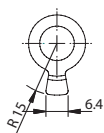

D cam

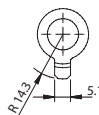

K cam

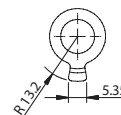

M cam

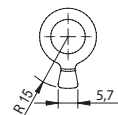

H cam

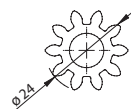

G cam

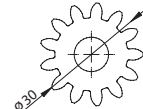

Z cam

Wireless Option

- = Standalone wire free SVN cylinder.
- W = Wireless online cylinder. **(VDS option not available)**

Panic function

- = No panic function
 - A = Panic function A
- Panic function a reset the cam to a specific position.

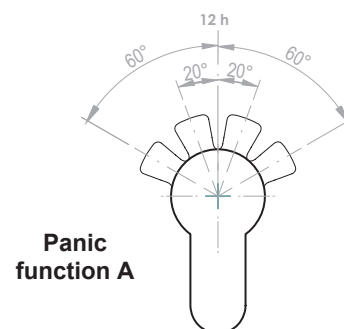

Certification

- = No special certification
- V = VDS Bz+ compliant (SKG*** compliant)
(VDS Cylinders are IPP66 as standard)
- G = SKG*** compliant
(SKG* Cylinders are IPP66 as standard)**

Water Resistance

- = IP55 Rating
- R = IP66 Rating Water Resistant **(SKG*** & VDS Cylinders are IPP66 as standard)**

* IP66: Only Electronic Knob

Model GxE1x SALTO GEO Half cylinder Euro profile Electronic cylinder
(Can be programmed as Selfprogrammable, ROM or RW cylinders)

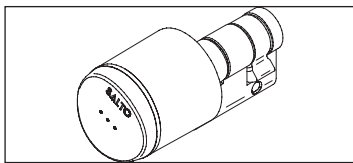

Technology	Model	Knob type	Outside length	Thumbturn	Inside length	Finish	Cams	Wireless	Certification	Water resistance					
G8 ^{1,2} LEGIC advant	E1	1 Removable Knob	30	N No thumbturn	00	CSB	D	-	-	No Certification	-				
			35			10mm						CPB			
			40		20	PPB*						K			
			45			PMB*									
			50		25	BCB BioCote*							Standalone		
			55			NEB*									
60		30	M ³ <i>For spanish metal door.</i>		W										
65						CSW									
G9 Mifare DESFire		E1	2 Removable Knob 5mm plug			70	N No thumbturn		30	CPW	G	-		V*, ¹ VDS Bz+ SKG*** (IP66)	-
						75				35					
						95			40				PMW*		
						1A (100mm.)				45			NEW*		
	1B (105mm.)			50	G*										
	1C (110mm.)					1J (145mm.)		SKG*** (IP66)							
1D (115mm.)	R*														
1E (120mm.)			IP66												
1F (125mm.)				IP66											
1G (130mm.)						IP66									
1H (135mm.)					IP66										
1I (140mm.)								IP66							
1J (145mm.)	IP66														
GH HID iCLASS		E1	3 Removable Knob 10mm plug				10		N No thumbturn	40	CPW	G	-	G*	SKG*** (IP66)
				11			45				PPW*				
				12		50				PMW*	Wireless online				
				13	55		NEW*			Z					
				14		60	G*								
	15			65	SKG*** (IP66)										
16	70		R*												
17				75		IP66									
18	80							IP66							
19				85						IP66					
20	90						IP66								
21				95	IP66										
22	100	IP66													
23			105	IP66											
24	110					IP66									
25			115					IP66							
26	120						IP66								
27			125		IP66										
28	130	IP66													
29			135	IP66											
30	140					IP66									
31			145					IP66							

Measures

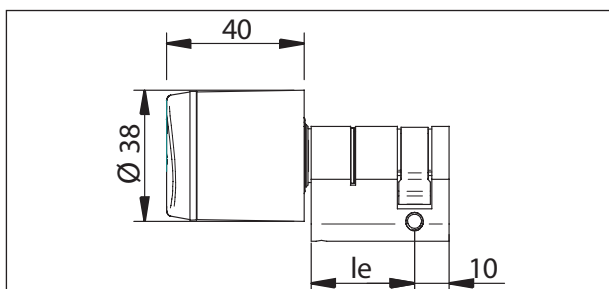

* This option has an additional price, please refer to the cylinder options chapter.

¹ Wireless version not available.

² LEGIC Cylinder can be slightly different

³ For spanish metal door.

M5 screw included.

For D and K cams 75mm length.

For M cam 35 mm length.

For total length > to 50, the cylinder body might be modular

Profile cylinder

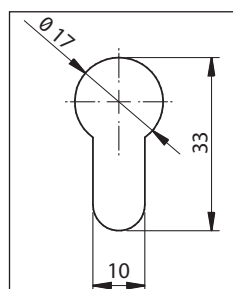

Cams

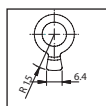

D cam

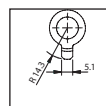

K cam

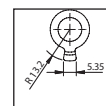

M cam

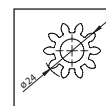

G cam

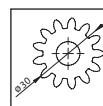



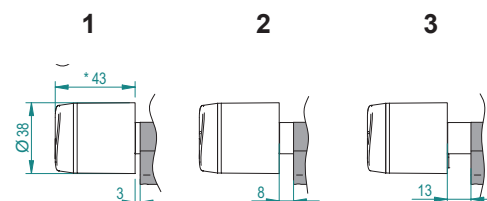

Z cam

Knob Type

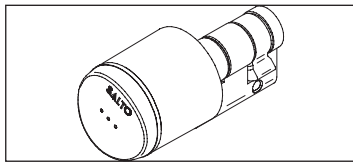

Model GxE1x	SALTO GEO Half cylinder Euro profile Electronic cylinder (Can be programmed as Selfprogrammable, ROM or RW cylinders)
--------------------	--



Prices - Gross prices		€
	LEGIC advant: Standard - standard length, cam and finish.	393,05
	Mifare DESFire: Standard - standard length, standard cams, standard finish.	393,05
	Mifare DESFire: Wireless - standard length, standard cams, standard finish.	528,75
	HID iCLASS: Standard - standard length, cam and finish.	541,40
	HID iCLASS: Wireless - standard length, cam and finish.	677,10

Additional Prices - Gross prices

Water resistance

Ref	Remarks	€
R	Water resistant (IP66)	16,90

Certification

Ref	Remarks	€
G	SKG*** compliant (IP66)	33,90
V	VDS - Bz+ (SKG***) compliant (IP66)	33,90

Finish options

Finish options		€
Satin Chromiun	G x x x x x x CS x x x	0,00
Polished Chromiun	G x x x x x x CP x x x	0,00
PVD Bright brass type	G x x x x x x PP x x x	5,50
PVD Satin brass type	G x x x x x x PM x x x	5,50
BioCoted Satin Chromiun	G x x x x x x BC x x x	40,80
Satin Chromiun Black	G x x x x x x NE x x x	8,65

Length options

L(mm) Total	Remarks	€
40mm up to 60mm		0,00
from 65mm up to 100mm		20,60
length over 100 mm		Upon request

Model GxE1xA

SALTO GEO half cylinder Euro profile Electronic cylinder
Antipanic function
(Can be programmed as Selfprogrammable, ROM or RW cylinders)

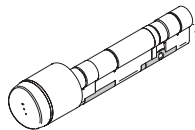

Technology	Model	Knob type	Outside length	Thumbturn	Inside length	Finish	Cams	Wireless	Panic function	Certification	Water resistance			
G8 ^{1,2} LEGIC advant	E1	1 Removable Knob	30	N No thumbturn	35	CSB	D	-	-	-	-			
			35			CPB								
			40			PPB*								
			45			PMB*								
			50			BCB BioCote*								
			55			NEB*								
60		CSW												
G9 Mifare DESFire		65	2 Removable Knob 5mm plug		70	65		75	CPW	W Wireless online	-	A Panic Function A	V*, ¹ VDS Bz+ SKG*** (IP66)	IP55
		75			PPW*									
		95			PMW*									
		1A -100mm.			NEW*									
		1B-105mm.												
		1C-110mm.												
GH HID iCLASS		1D-115mm.	3 Removable Knob 10mm plug		1E-120mm.	70		95					G* SKG*** (IP66)	R* IP66
		1F-125mm.												
		1G-130mm.												
		1H-135mm.												
		1I-140mm.												
	1J-145mm.													

Measures

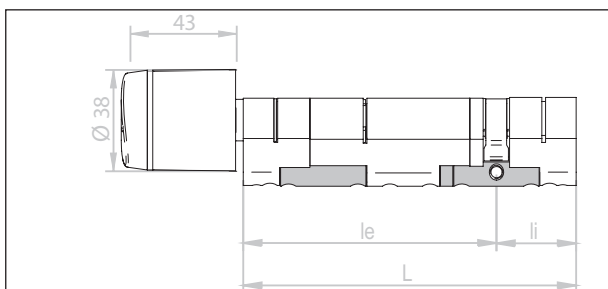

* This option has an additional price, please refer to the cylinder options chapter.
¹ Wireless version not available.
² LEGIC Cylinder can be slightly different

M5 screw included.
For D cams 75mm length.

Profile cylinder

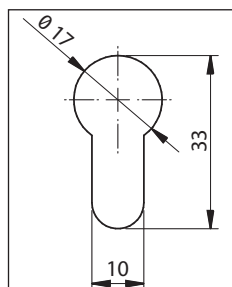

Antipanic function

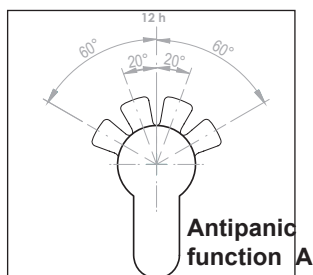

Cams

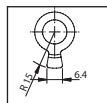

D cam

Knob Type

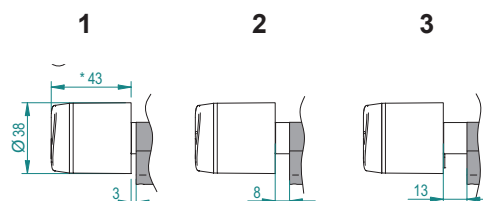

Model GxE1xA

SALTO GEO half cylinder Euro profile Electronic cylinder
Antipanic function
(Can be programmed as Selfprogrammable, ROM or RW cylinders)

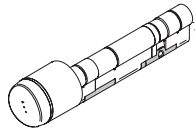

Prices - Gross prices



LEGIC advant: Standard - standard length, cam and finish.

452,40



Mifare DESFire: Standard - standard length, standard cams, standard finish.

452,40

Mifare DESFire: Wireless - standard length, standard cams, standard finish.

588,00



HID iCLASS: Standard - standard length, cam and finish.

600,85

HID iCLASS: Wireless - standard length, cam and finish.

736,50

Additional Prices - Gross prices

Water resistance

Ref	Remarks	€
R	Water resistant (IP66)	16,90

Certification

Ref	Remarks	€
G	SKG*** compliant (IP66)	33,90
V	VDS - Bz+ (SKG***) compliant (IP66)	33,90

Finish options

		€
Satin Chromiun	G x x x x x x CS x x x	0,00
Polished Chromiun	G x x x x x x CP x x x	0,00
PVD Bright brass type	G x x x x x x PP x x x	5,50
PVD Satin brass type	G x x x x x x PM x x x	5,50
BioCoted Satin Chromiun	G x x x x x x BC x x x	40,80
Satin Chromiun Black	G x x x x x x NE x x x	8,65

Length options

L(mm) Total	Remarks	€
40mm up to 80mm		0,00
from 85mm up to 100mm		20,60
from 105 mm up to 120 mm		54,85
from 125 mm up to 145 mm		109,60
length over 150 mm		Upon request

Model GxE2x

SALTO GEO Euro profile electronic cylinder
 Standard cylinder, one knob, one thumbturn
 (Can be programmed as Selfprogrammable, ROM or RW cylinders)

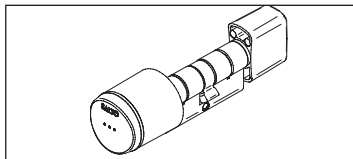

Technology	Model	Knob type	Outside length	Thumbturn	Inside length	Finish	Cams	Wireless	Certification	Water resistance					
G8 ^{1,2} LEGIC advant	E2	1 Removable Knob	30	S Standard	10	CSB	D	-	-	-					
			35		15										
			40		20	CPB									
			45		25										
			50		30	PPB*					K				
			55		35										
			60		40										
G9 Mifare DESFire		2 Removable Knob 5mm plug	65		45	BCB BioCote*	M ³		-	-		-			
			·		·										
			·		·	NEB*									
1C (110mm.)		1C (110mm.)	CSW		G		W Wireless online		-	-					
1D (115mm.)		1D (115mm.)													
GH HID iCLASS		3 Removable Knob 10mm plug	1E (120mm.)			1E (120mm.)					CPW	Z	-	-	-
			1F (125mm.)			1F (125mm.)									
	1G (130mm.)		1G (130mm.)	PPW*											
	1H (135mm.)		1H (135mm.)												
	1I (140mm.)		1I (140mm.)	PMW*											
	1J (145mm.)		1J (145mm.)												
	1K (150mm.)		1K (150mm.)	NEW*											

Measures

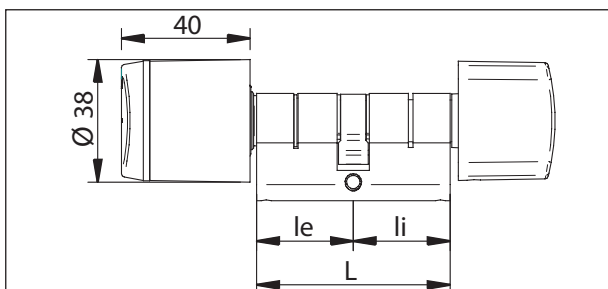

* This option has an additional price, please refer to the cylinder options chapter.

¹ Wireless version not available.

² LEGIC Cylinder can be slightly different

³ For spanish metal door.

M5 screw included.

For D and K cams 75mm length.

For M cam 35 mm length.

For total length > to 85, the cylinder body might be modular

Profile cylinder

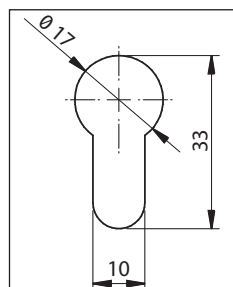

Cams

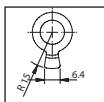

D cam

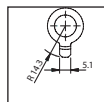

K cam

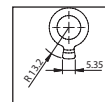

M cam

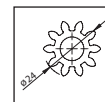

G cam

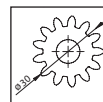

Z cam

Knob Type

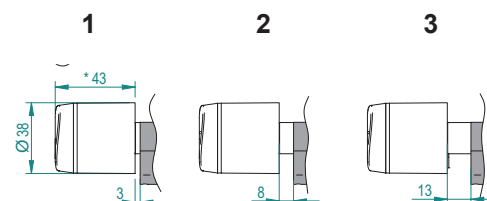

Model GxE2x	SALTO GEO Euro profile electronic cylinder Standard cylinder, one knob, one thumbturn (Can be programmed as Selfprogrammable, ROM or RW cylinders)
--------------------	--

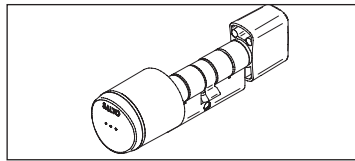

Prices - Gross prices		€
	LEGIC advant: Standard - standard length, cam and finish.	404,40
	Mifare DESFire: Standard - standard length, standard cams, standard finish.	404,40
	Mifare DESFire: Wireless - standard length, standard cams, standard finish.	540,15
	HID iCLASS: Standard - standard length, cam and finish.	552,95
	HID iCLASS: Wireless - standard length, cam and finish.	688,50

Additional Prices - Gross prices

Water resistance

Ref	Remarks	€
R	Water resistant (IP66)	16,90

Certification

Ref	Remarks	€
G	SKG*** compliant (IP66)	33,90
V	VDS - Bz+ (SKG***) compliant (IP66)	33,90

Finish options

Finish options		€
Satin Chromiun	G x x x x x x CS x x x	0,00
Polished Chromiun	G x x x x x x CP x x x	0,00
PVD Bright brass type	G x x x x x x PP x x x	5,50
PVD Satin brass type	G x x x x x x PM x x x	5,50
BioCoted Satin Chromiun	G x x x x x x BC x x x	40,80
Satin Chromiun Black	G x x x x x x NE x x x	8,65

Length options

L(mm) Total	Remarks	€
40mm up to 80mm		0,00
from 85mm up to 100mm		20,60
from 105 mm up to 120 mm		54,85
from 125 mm up to 145 mm		109,60
lenght over 150 mm		Upon request

Thumbturns

Thumbturns		€
S		0,00
R		6,90

Model GxE2A	SALTO GEO Euro profile electronic cylinder Antipanic function - Standard cylinder, one knob, one thumbturn (Can be programmed as Selfprogrammable, ROM or RW cylinders)
--------------------	---

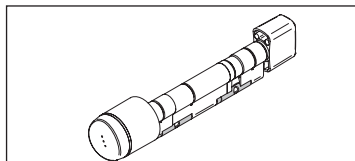

Technology	Model	Knob type	Outside length	Thumbturn	Inside length	Finish	Cams	Wireless	Panic function	Certification	Water resistance				
G8 ^{1,2} LEGIC advant	E2	1 Removable Knob	30	S Standard	35	CSB	D	-	Stand-alone	-	-	IP55			
			35												
			40												
			45												
			50												
			55												
60															
G9 Mifare DESFire		65	2 Removable Knob 5mm plug	70	R*	65				BCB BioCote*	W Wireless online	-	A Panic Function A	V*, ¹ VDS Bz+ SKG*** (IP66)	R*
				75											
				95											
				1A -100mm.											
				1B-105mm.											
	1C-110mm.														
GH HID iCLASS	1D-115mm.	3 Removable Knob 10mm plug	1E-120mm.	Round	75	CPW	-	-	-	G* SKG*** (IP66)	IP66				
			1F-125mm.												
			1G-130mm.												
			1H-135mm.												
			1I-140mm.												
			1J-145mm.												
			1A -100mm.												
			1B-105mm.												
			1C-110mm.												
			1D-115mm.												

Measures

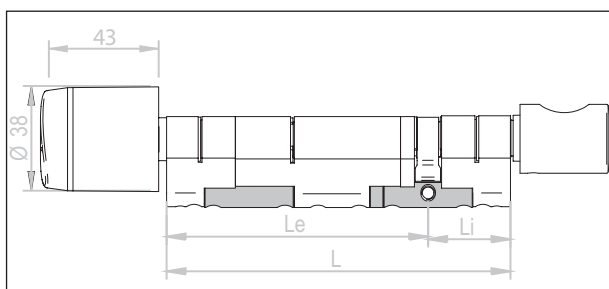

* This option has an additional price, please refer to the cylinder options chapter.
¹ Wireless version not available.
² LEGIC Cylinder can be slightly different

M5 screw included.
 For D cams 75mm length.

Profile cylinder

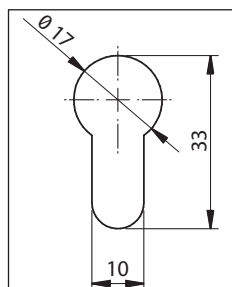

Antipanic function

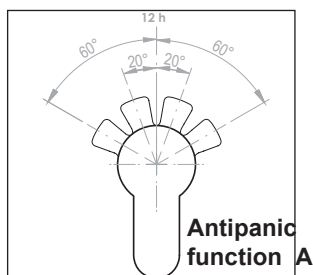

Cams

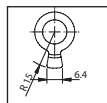

D cam

Knob Type

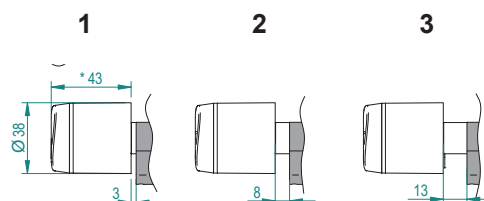

Model GxE2xA

SALTO GEO Euro profile electronic cylinder
Antipanic function - Standard cylinder, one knob, one thumbturn
(Can be programmed as Selfprogrammable, ROM or RW cylinders)

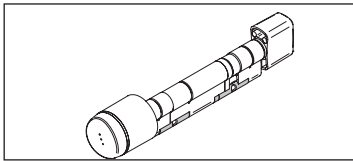

Prices - Gross prices		€
	LEGIC advant: Standard - standard length, cam and finish.	463,75
	Mifare DESFire: Standard - standard length, standard cams, standard finish.	463,75
	Mifare DESFire: Wireless - standard length, standard cams, standard finish.	599,45
	HID iCLASS: Standard - standard length, cam and finish.	612,25
	HID iCLASS: Wireless - standard length, cam and finish.	747,90

Additional Prices - Gross prices

Water resistance

Ref	Remarks	€
R	Water resistant (IP66)	16,90

Certification

Ref	Remarks	€
G	SKG*** compliant (IP66)	33,90
V	VDS - Bz+ (SKG***) compliant (IP66)	33,90

Finish options

		€
Satin Chromiun	G x x x x x x CS x x x	0,00
Polished Chromiun	G x x x x x x CP x x x	0,00
PVD Bright brass type	G x x x x x x PP x x x	5,50
PVD Satin brass type	G x x x x x x PM x x x	5,50
BioCoted Satin Chromiun	G x x x x x x BC x x x	40,80
Satin Chromiun Black	G x x x x x x NE x x x	8,65

Length options

L(mm) Total	Remarks	€
65mm up to 80mm		0,00
from 85mm up to 100mm		20,60
from 105 mm up to 120 mm		54,85
from 125 mm up to 145 mm		109,60
length over 150 mm		Upon request

Thumbturns

		€
S		0,00
R		6,90

<h3>Model GxE2K</h3>	<p>SALTO GEO Euro profile electronic cylinder AMOK function - Standard cylinder, one knob, one thumbturn (Can be programmed as Selfprogrammable, ROM or RW cylinders)</p>
----------------------	---

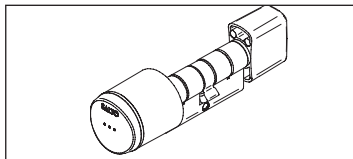

Technology	Model	Knob type	Outside length	Thumbturn	Inside length	Finish	Cams	Wireless	Panic function	Certification	Water resistance							
G8 ^{1,2} LEGIC advant	E2	1 Removable Knob	30	S Standard	35	CSB	D	-	Stand-alone	-	-	IP55						
			35															
			40															
			45															
			50															
			55															
60																		
G9 Mifare DESFire		65	2 Removable Knob 5mm plug	70	R [*] Round	65							BCB BioCote [*]	W Wireless online	K AMOK Function	-	No certification	R [*] IP66
				75														
				95														
				1A -100mm.														
				1B-105mm.														
	1C-110mm.																	
GH HID iCLASS	1D-115mm.	3 Removable Knob 10mm plug	1E-120mm.	75	70	CPW	-	-	-	-	-							
			1F-125mm.															
			1G-130mm.															
			1H-135mm.															
			1I-140mm.															
			1J-145mm.															
1A -100mm.																		
1B-105mm.																		
NEW [*]																		

Measures

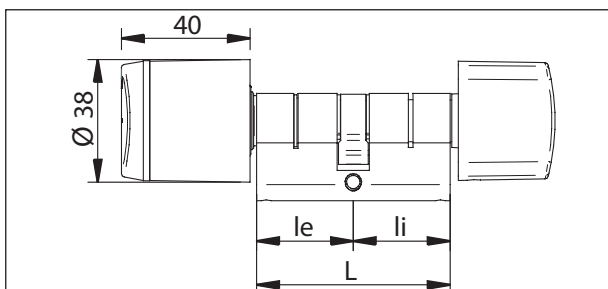

^{*} This option has an additional price, please refer to the cylinder options chapter.
¹ Wireless version not available.
² LEGIC Cylinder can be slightly different

M5 screw included.
 For D cams 75mm length.

Profile cylinder

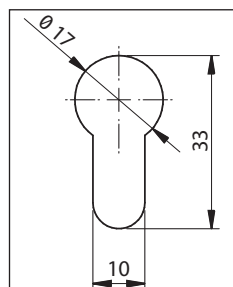

Cams

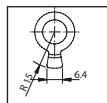

D cam

Knob Type

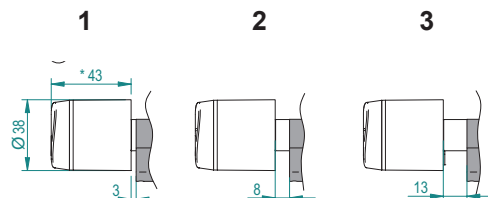

Model GxE2xK

SALTO GEO Euro profile electronic cylinder
AMOK function - Standard cylinder, one knob, one thumbturn
(Can be programmed as Selfprogrammable, ROM or RW cylinders)

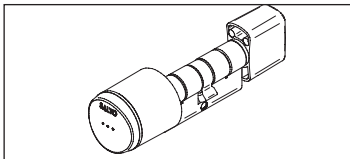

Prices - Gross prices

		€
	LEGIC advant: Standard - standard length, cam and finish.	507,70
	Mifare DESFire: Standard - standard length, standard cams, standard finish.	507,70
	Mifare DESFire: Wireless - standard length, standard cams, standard finish.	643,35
	HID iCLASS: Standard - standard length, cam and finish.	656,10
	HID iCLASS: Wireless - standard length, cam and finish.	791,75

Additional Prices - Gross prices

Water resistance

Ref	Remarks	€
R	Water resistant (IP66)	16,90

Finish options

		€
Satin Chromiun	G x x x x x x CS x x x	0,00
Polished Chromiun	G x x x x x x CP x x x	0,00
PVD Bright brass type	G x x x x x x PP x x x	5,50
PVD Satin brass type	G x x x x x x PM x x x	5,50
BioCoted Satin Chromiun	G x x x x x x BC x x x	40,80
Satin Chromiun Black	G x x x x x x NE x x x	8,65

Length options

L(mm) Total	Remarks	€
65mm up to 80mm		0,00
from 85mm up to 100mm		20,60
from 105 mm up to 120 mm		54,85
from 125 mm up to 145 mm		109,60
length over 150 mm		Upon request

Thumbturns

		€
S		0,00
R		6,90

Model GxE3x

SALTO GEO Electronic Euro profile double cylinder
 Standard cylinder, two knob.
 (Can be programmed as Selfprogrammable, ROM or RW cylinders)

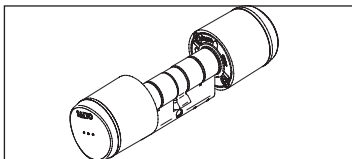

Technology	Model	Knob type	Outside length	Thumbturn	Inside length	Finish	Cams	Wireless	Certification	Water resistance				
G8 ^{1,2} LEGIC advant	E3	1 Removable Knob	30	N No thumbturn	30	CSB	D	-	-	-				
			35		35						CPB			
			40		40	PPB*								
			45		45						PMB*			
			50		50							K		
			55		55	Standalone								
			60		60						BCB BioCote*			
65		65	M ³											
G9 Mifare DESFire		2 ⁴ Removable Knob 5mm plug			·	·	1C (110mm.)		CSW	G	W	V*, ¹ VDS Bz+ SKG*** (IP66)	-	
			·		·	1D (115mm.)								CPW
			1C (110mm.)		1C (110mm.)									
GH HID iCLASS		3 ⁴ Removable Knob 10mm plug	1E (120mm.)		1E (120mm.)	1H (135mm.)	PMW*		Z	Wireless online	G* SKG*** (IP66)	R* IP66		
			1F (125mm.)		1F (125mm.)								1J (145mm.)	NEW*
			1G (130mm.)		1G (130mm.)	1K (150mm.)								
	1H (135mm.)		1H (135mm.)											
	1I (140mm.)		1I (140mm.)											
	1J (145mm.)		1J (145mm.)											
	1K (150mm.)		1K (150mm.)											

Measures

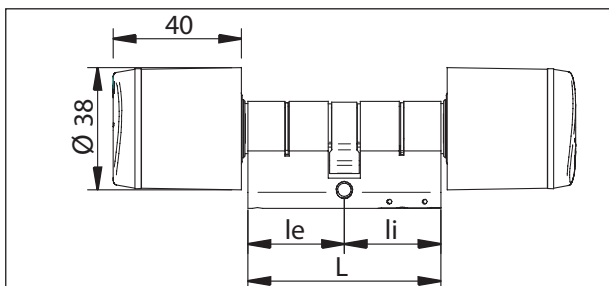

* This option has an additional price, please refer to the cylinder options chapter.

- ¹ Wireless version not available.
- ² LEGIC Cylinder can be slightly different
- ³ For spanish metal door.
- ⁴ When used with double reader units, the knob type applies only to the external knob. Internal knob will always be "1"

M5 screw included.
 For D and K cams 75mm length.
 For M cam 35 mm length.

For total length > to 85, the cylinder body might be modular

Profile cylinder

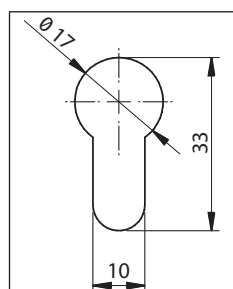

Cams

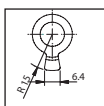

D cam

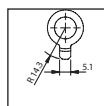

K cam

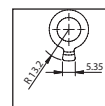

M cam

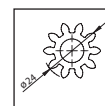

G cam

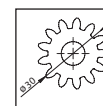

Z cam

Knob Type

1

2

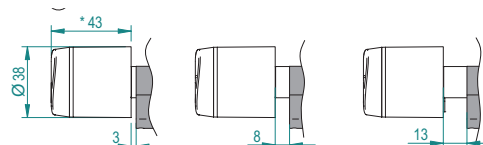

3

Only for outside knob.
 Inside remains standard (3mm)

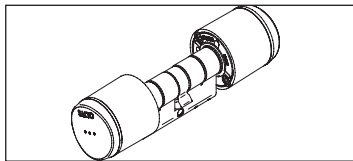

Model GxE3x	SALTO GEO Electronic Euro profile double cylinder Standard cylinder, two knob. (Can be programmed as Selfprogrammable, ROM or RW cylinders)
--------------------	---



Prices - Gross prices		€
 LEGIC <small>advant innovation in ID technology</small>	LEGIC advant: Standard - standard length, cam and finish.	495,70
	Mifare DESFire: Standard - standard length, standard cams, standard finish.	495,70
	Mifare DESFire: Wireless - standard length, standard cams, standard finish.	631,40
	HID iCLASS: Standard - standard length, cam and finish.	644,15
	HID iCLASS: Wireless - standard length, cam and finish.	779,90

Additional Prices - Gross prices

Water resistance

Ref	Remarks	€
R	Water resistant (IP66)	16,90

Certification

Ref	Remarks	€
G	SKG*** compliant (IP66)	33,90
V	VDS - Bz+ (SKG***) compliant (IP66)	33,90

Finish options

		€
Satin Chromiun	G x x x x x x CS x x x	0,00
Polished Chromiun	G x x x x x x CP x x x	0,00
PVD Bright brass type	G x x x x x x PP x x x	5,50
PVD Satin brass type	G x x x x x x PM x x x	5,50
BioCoted Satin Chromiun	G x x x x x x BC x x x	40,80
Satin Chromiun Black	G x x x x x x NE x x x	8,65

Length options

L(mm) Total	Remarks	€
40mm up to 80mm		0,00
from 85mm up to 100mm		20,60
from 105 mm up to 120 mm		54,85
from 125 mm up to 145 mm		109,60
length over 150 mm		Upon request

Model GxE9x

SALTO GEO Electronic half cylinder for server rack swing handles
(Can be programmed as Selfprogrammable, ROM or RW cylinders)

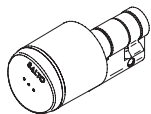

Technology	Model	Knob type	Outside length	Thumbturn	Inside length	Finish	Cams	Wireless	Certification	Water resistance				
G8 ^{1,2} LEGIC advant	E9	1 Removable Knob	30	N No thumbturn	00 10 mm	CSB	R	-	-	-				
						CPB								
						PPB*								
G9 Mifare DESFire		2 Removable Knob 5mm plug	35			BCB BioCote*		NEB*	CSW	W Wireless online	-	No Certification	R*	
														CPW
														PPW*
GH HID iCLASS		3 Removable Knob 10mm plug	35			PMW*		NEW*	IP66					

Measures

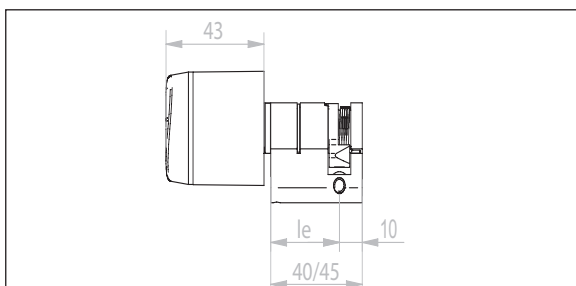

* This option has an additional price, please refer to the cylinder options chapter.
¹ Wireless version not available.
² LEGIC Cylinder can be slightly different

M5X45 screw included

**Swing handle not included-
SALTO does not provide swing handles**

Profile cylinder

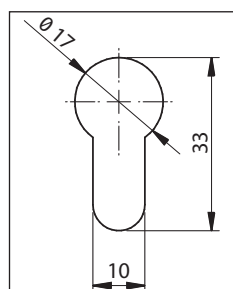

Cams

R cam

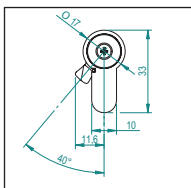



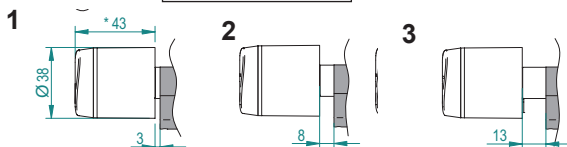

Knob Type

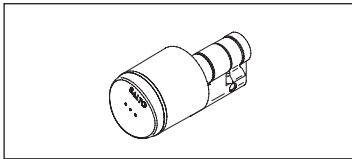

	Profile cylinders	Swinghandles
DIRAK®*	A- A1 - B - F, type	2-080.01, 2-080.02, 2-090, 2-100.01, 2-120, 2-300,
EMKA®*	3XB-120, 3XB-220, 3XB-320	3A-120, 3A-220, 3A-310, 3A-320, 3B-220, 3B-320,

Model GxE9x	SALTO GEO Electronic half cylinder for server rack swing handles (Can be programmed as Selfprogrammable, ROM or RW cylinders)
--------------------	--



Prices - Gross prices		€
	LEGIC advant: Standard - standard length, cam and finish.	420,25
	Mifare DESFire: Standard - standard length, standard cams, standard finish.	420,25
	Mifare DESFire: Wireless - standard length, standard cams, standard finish.	555,90
	HID iCLASS: Standard - standard length, cam and finish.	568,60
	HID iCLASS: Wireless - standard length, cam and finish.	704,25

Additional Prices - Gross prices

Water resistance

Ref	Remarks	€
R	Water resistant (IP66)	16,90

Certification

Ref	Remarks	€
-----	---------	---

Finish options

		€
Satin Chromiun	G x x x x x x CS x x x	0,00
Polished Chromiun	G x x x x x x CP x x x	0,00
PVD Bright brass type	G x x x x x x PP x x x	5,50
PVD Satin brass type	G x x x x x x PM x x x	5,50
BioCoted Satin Chromiun	G x x x x x x BC x x x	40,80
Satin Chromiun Black	G x x x x x x NE x x x	8,65

Model GxCLx

SALTO GEO Cam lock electronic cylinder
(Can be programmed as Selfprogrammable, ROM or RW cylinders)

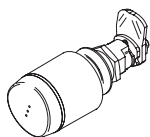

Technology	Model	Knob type	Cylinder body Ø	Door thickness	Cam height	Finish	Cams	Wireless	Certification	Water resistance
G8 ^{1,2} LEGIC advant	CL	1 Removable Knob	19	M 1mm to 15mm	28 28mm		CSB	-	-	-
							CPB			
							PPB*			
							PMB*			
G9 Mifare DESFire	CL	1 Removable Knob	19	W 15mm < t < 22mm	40 40mm		BCB BioCote*	A	-	-
							NEB*			
							CSW			
GH HID iCLASS	CL	1 Removable Knob	19	W 15mm < t < 22mm	40 40mm		CPW	W	-	-
							PPW*			
							PMW*			
							NEW*			
								W	No Certification	R* IP66

Measures

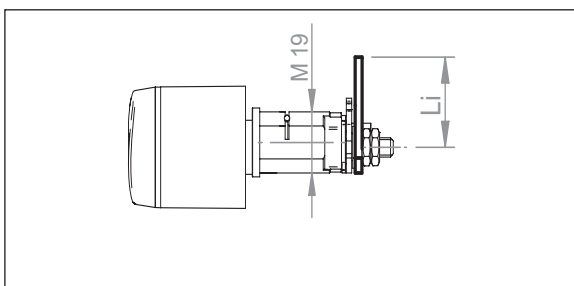

* This option has an additional price, please refer to the cylinder options chapter.
¹ Wireless version not available.
² LEGIC Cylinder can be slightly different

CAM and Security collars included

Profile cylinder

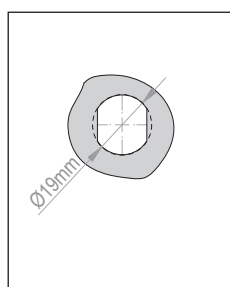

Knob Type

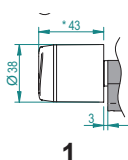

1

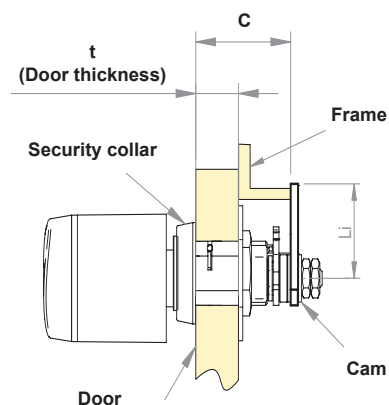

Model GxCLx	SALTO GEO Cam lock electronic cylinder (Can be programmed as Selfprogrammable, ROM or RW cylinders)
--------------------	--

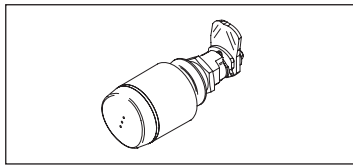

Prices - Gross prices		€
LEGIC advant: Standard - standard length, cam and finish.		424,50
Mifare DESFire: Standard - standard length, standard cams, standard finish.		424,50
Mifare DESFire: Wireless - standard length, standard cams, standard finish.		560,15
HID iCLASS: Standard - standard length, cam and finish.		573,00
HID iCLASS: Wireless - standard length, cam and finish.		708,70

Additional Prices - Gross prices

Water resistance

Ref	Remarks	€
R	Water resistant (IP66)	16,90

Finish options

		€
Satin Chromiun	G x x x x x x CS x x x	0,00
Polished Chromiun	G x x x x x x CP x x x	0,00
PVD Bright brass type	G x x x x x x PP x x x	5,50
PVD Satin brass type	G x x x x x x PM x x x	5,50
BioCoted Satin Chromiun	G x x x x x x BC x x x	40,80
Satin Chromiun Black	G x x x x x x NE x x x	8,65

Standard cams

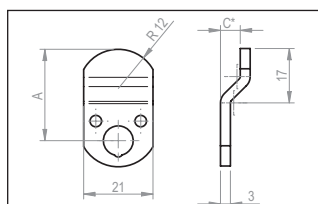

REF.	QTY (min 20)	A	C*	€
SP221220-0120	20	28	0	121,40
SP221220-0220	20	40	0	121,40
SP221150-0120	20	28	6	121,40
SP221150-0220	20	40	6	121,40

Cam lock strike plate

Reference	Quantity	€
SP221386-10	10	102,50

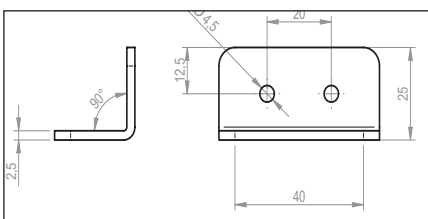

Customized cam lock

SALTO offers the possibility to order customized cams for SALTO cam lock cylinders. Please request for a quotation by detailing the dimensions and characteristics of the cam by sending this information to SALTO.

CUSTOMIZED CAMS

QUANT. (min 20)	DIMENSIONS				
	A (≥30)	B (≥21)	C*	R ≥ (2B/3)	E ≤ (A-10)

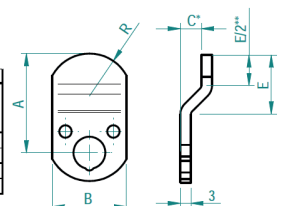

*C=0 (STRAIGHT CAM)
** Recommended straight part length = E/2
Other Cam shapes under request.

Model GxU1x

SALTO GEO UK oval profile half electronic cylinder
One knob, no thumbturn.
(Can be programmed as Selfprogrammable, ROM or RW cylinders)

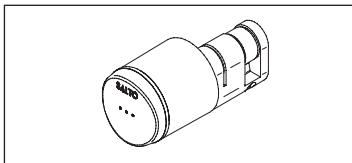

Technology	Model	Knob type	Outside length	Thumbturn	Inside length	Finish	Cams	Wireless	Certification	Water resistance				
G8 ^{1,2} LEGIC advant	U1	1 Removable Knob	30	N No thumbturn	00 10mm	CSB	K	-	No Certification	-				
			35			CPB								
			40			PPB*								
			45			PMB*								
			50			BCB BioCote*								
			55			NEB*								
60		CSW												
G9 Mifare DESFire		2 Removable Knob 5mm plug	65			1A (100mm.)					CPW	W Wireless online	G* SKG*** (IP66)	R* IP66
			70			1B (105mm.)					PPW*			
			75			1C (110mm.)					PMW*			
			95			1D (115mm.)					NEW*			
			1A (100mm.)			1E (120mm.)								
	1B (105mm.)		1F (125mm.)											
GH HID iCLASS	3 Removable Knob 10mm plug	1C (110mm.)	1G (130mm.)											
		1D (115mm.)	1H (135mm.)											
		1E (120mm.)	1I (140mm.)											
		1F (125mm.)	1J (145mm.)											
		1G (130mm.)												
		1H (135mm.)												

Measures

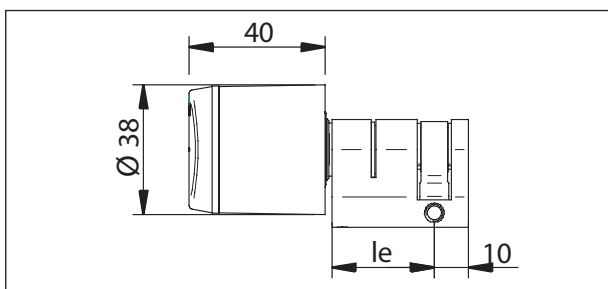

* This option has an additional price, please refer to the cylinder options chapter.
¹ Wireless version not available.
² LEGIC Cylinder can be slightly different

M5 x 75mm screw included.

Profile cylinder

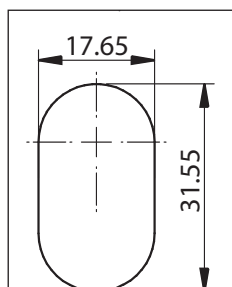

Cams

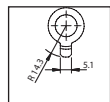

K cam

Knob Type

Only for outside knob.
Inside remains standard (3mm)

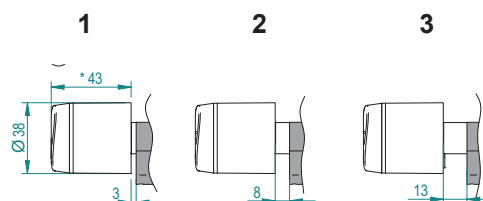

Model GxU1x	SALTO GEO UK oval profile half electronic cylinder One knob, no thumbturn. (Can be programmed as Selfprogrammable, ROM or RW cylinders)
--------------------	---

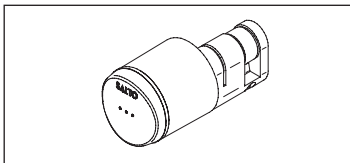

Prices - Gross prices		€
LEGIC <small>advant innovation in ID technology</small>	LEGIC advant: Standard - standard length, cam and finish.	406,80
MIFARE DESFire	Mifare DESFire: Standard - standard length, standard cams, standard finish.	406,80
	Mifare DESFire: Wireless - standard length, standard cams, standard finish.	528,75
iCLASS <small>by HID</small>	HID iCLASS: Standard - standard length, cam and finish.	555,15
	HID iCLASS: Wireless - standard length, cam and finish.	677,10

Additional Prices - Gross prices

Water resistance

Ref	Remarks	€
R	Water resistant (IP66)	16,90

Certification

Ref	Remarks	€
G	SKG*** compliant (IP66)	33,90
V	VDS - Bz+ (SKG***) compliant (IP66)	33,90

Finish options

		€
Satin Chromiun	G x x x x x x x CS x x x	0,00
Polished Chromiun	G x x x x x x x CP x x x	0,00
PVD Bright brass type	G x x x x x x x PP x x x	5,50
PVD Satin brass type	G x x x x x x x PM x x x	5,50
BioCoted Satin Chromiun	G x x x x x x x BC x x x	40,80
Satin Chromiun Black	G x x x x x x x NE x x x	8,65

Length options

L(mm) Total	Remarks	€
40mm up to 60mm		0,00
from 65mm up to 100mm		20,60
length over 100 mm		Upon request

Model GxU2x

SALTO GEO UK oval profile electronic cylinder
 Standard cylinder, one knob, one thumbturn.
 (Can be programmed as Selfprogrammable, ROM or RW cylinders)

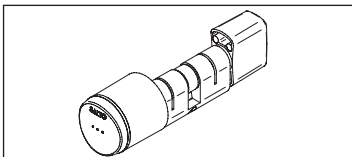

Technology	Model	Knob type	Outside length	Thumbturn	Inside length	Finish	Cams	Wireless	Certification	Water resistance	
G8 ^{1,2} LEGIC advant	U2	1 Removable Knob	30	S Standard	10	CSB	K	-	-	-	
			35		15						
			40		20	CPB					
			45		25						
			50		30	PPB*					
			55		35						
60		40	PMB*								
65		45									
G9 Mifare DESFire		2 Removable Knob 5mm plug	70	R* Round	1C (110mm.)	BCB BioCote*					
			75								NEB*
			95			CSW					
			1A (100mm.)								1D (115mm.)
			1B (105mm.)			1E (120mm.)					
			1C (110mm.)								1F (125mm.)
1D (115mm.)		1G (130mm.)	PPW*								
1E (120mm.)				1H (135mm.)							
1F (125mm.)		1I (140mm.)	PMW*								
1G (130mm.)				1J (145mm.)							
1H (135mm.)	1K (150mm.)	NEW*									
1I (140mm.)											
1J (145mm.)											
GH HID iCLASS	3 Removable Knob 10mm plug										

Measures

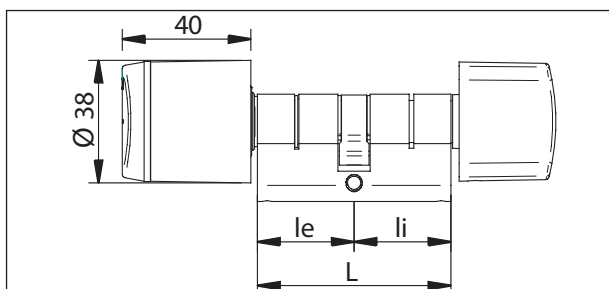

* This option has an additional price, please refer to the cylinder options chapter.
¹ Wireless version not available.
² LEGIC Cylinder can be slightly different

M5 x 75mm screw included.

Profile cylinder

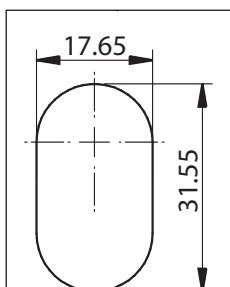

Cams

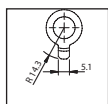

K cam

Knob Type

Only for outside knob.
 Inside remains standard (3mm)

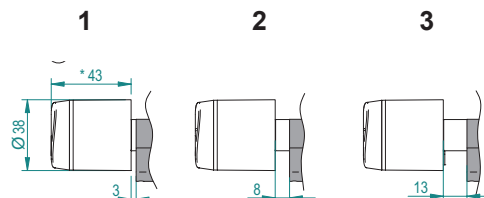

Model GxU2x	SALTO GEO UK oval profile electronic cylinder Standard cylinder, one knob, one thumbturn. (Can be programmed as Selfprogrammable, ROM or RW cylinders)
--------------------	--

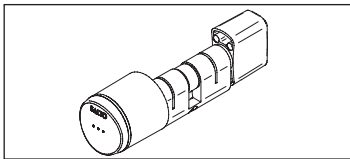

Prices - Gross prices		€
	LEGIC advant: Standard - standard length, cam and finish.	424,50
	Mifare DESFire: Standard - standard length, standard cams, standard finish.	424,50
	Mifare DESFire: Wireless - standard length, standard cams, standard finish.	540,15
	HID iCLASS: Standard - standard length, cam and finish.	573,00
	HID iCLASS: Wireless - standard length, cam and finish.	688,50

Additional Prices - Gross prices

Water resistance

Ref	Remarks	€
R	Water resistant (IP66)	16,90

Certification

Ref	Remarks	€
G	SKG*** compliant (IP66)	33,90
V	VDS - Bz+ (SKG***) compliant (IP66)	33,90

Finish options

		€
Satin Chromiun	G x x x x x x CS x x x	0,00
Polished Chromiun	G x x x x x x CP x x x	0,00
PVD Bright brass type	G x x x x x x PP x x x	5,50
PVD Satin brass type	G x x x x x x PM x x x	5,50
BioCoted Satin Chromiun	G x x x x x x BC x x x	40,80
Satin Chromiun Black	G x x x x x x NE x x x	8,65

Length options

L(mm) Total	Remarks	€
40mm up to 80mm		0,00
from 85mm up to 100mm		20,60
from 105 mm up to 120 mm		54,85
from 125 mm up to 145 mm		109,60
length over 150 mm		Upon request

Thumbturns

		€
S		0,00
R		6,90

Model GxU3x

SALTO GEO UK oval profile electronic double cylinder
 Standard cylinder, two knob.
 (Can be programmed as Selfprogrammable, ROM or RW cylinders)

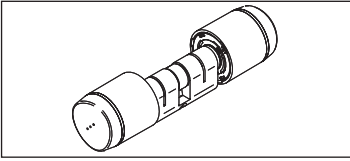

Technology	Model	Knob type	Outside length	Thumbturn	Inside length	Finish	Cams	Wireless	Certification	Water resistance			
G8 ^{1,2} LEGIC advant	U3	1 Removable Knob	30	N No thumbturn	10	CSB	K	-	-	-			
			35		20								
			40		25	CPB							
			45		30								
			50		35	PPB*							
			55		40								
			60		45	PMB*							
65		50											
G9 Mifare DESFire		2 ³ Removable Knob 5mm plug	70		BCB BioCote*								
			75			NEB*							
			95								CSW		
			1A (100mm.)									CPW	
			1B (105mm.)										1C (110mm.)
			1C (110mm.)										
1D (115mm.)		1E (120mm.)											
1E (120mm.)			1F (125mm.)										
1F (125mm.)					1G (130mm.)								
1G (130mm.)						1H (135mm.)							
1H (135mm.)											1I (140mm.)		
1I (140mm.)												1J (145mm.)	
1J (145mm.)		1K (150mm.)											
1K (150mm.)	NEW*												
GH HID iCLASS			3 ³ Removable Knob 10mm plug	1D (115mm.)	W Wireless online		G* SKG*** (IP66)	R* IP66					
				1E (120mm.)									
				1F (125mm.)									
				1G (130mm.)									
		1H (135mm.)											
	1I (140mm.)												

Measures

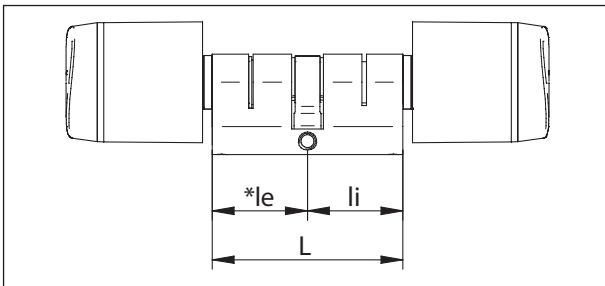

- * This option has an additional price, please refer to the cylinder options chapter.
- ¹ Wireless version not available.
- ² LEGIC Cylinder can be slightly different
- ³ When used with double reader units, the knob type applies only to the external knob. Internal knob will always be "1"

M5 x 75mm screw included.

Profile cylinder

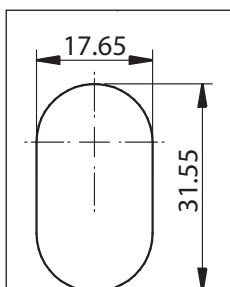

Cams

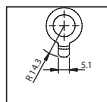

K cam

Knob Type

Only for outside knob.
 Inside remains standard (3mm)

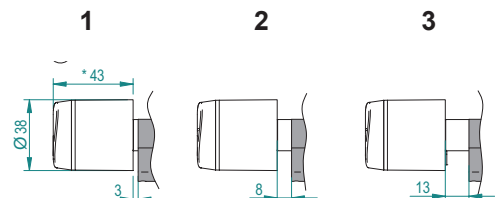

Model GxU3x	SALTO GEO UK oval profile electronic double cylinder Standard cylinder, two knob. (Can be programmed as Selfprogrammable, ROM or RW cylinders)
--------------------	--

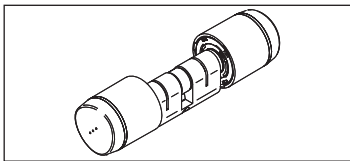

Prices - Gross prices	€
------------------------------	---

	LEGIC advant: Standard - standard length, cam and finish.	495,70
	Mifare DESFire: Standard - standard length, standard cams, standard finish.	495,70
	Mifare DESFire: Wireless - standard length, standard cams, standard finish.	631,40
	HID iCLASS: Standard - standard length, cam and finish.	644,15
	HID iCLASS: Wireless - standard length, cam and finish.	779,90

Additional Prices - Gross prices

Water resistance

Ref	Remarks	€
R	Water resistant (IP66)	16,90

Certification

Ref	Remarks	€
G	SKG*** compliant (IP66)	33,90
V	VDS - Bz+ (SKG***) compliant (IP66)	33,90

Finish options

		€
Satin Chromiun	G x x x x x x CS x x x	0,00
Polished Chromiun	G x x x x x x CP x x x	0,00
PVD Bright brass type	G x x x x x x PP x x x	5,50
PVD Satin brass type	G x x x x x x PM x x x	5,50
BioCoted Satin Chromiun	G x x x x x x BC x x x	40,80
Satin Chromiun Black	G x x x x x x NE x x x	8,65

Length options

L(mm) Total	Remarks	€
40mm up to 80mm		0,00
from 85mm up to 100mm		20,60
from 105 mm up to 120 mm		54,85
from 125 mm up to 145 mm		109,60
length over 150 mm		Upon request

Model GxH1x

SALTO GEO Swiss profile half electronic cylinder
One knob, no thumbturn.
(Can be programmed as Selfprogrammable, ROM or RW cylinders)

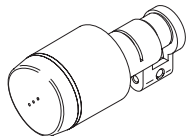

Technology	Model	Knob type	Outside length	Thumbturn	Inside length	Finish	Cams	Wireless	Certification	Water resistance									
G8 ^{1,2} LEGIC advant	H1	1 Removable Knob	30	N No thumbturn	00 10mm	CSB	H	-	-	-									
			35			CPB													
			40			PPB*													
			45			PMB*													
			50			BCB BioCote*													
			55			NEB*													
60		CSW																	
G9 Mifare DESFire		2 Removable Knob 5mm plug	65			1A (100mm.)	G				CPW	W Wireless online	G*	SKG*** (IP66)	R*				
			70													1B (105mm.)			
			75														1C (110mm.)		
			95															1D (115mm.)	
			1A (100mm.)																1E (120mm.)
			1B (105mm.)																
1C (110mm.)		1G (130mm.)																	
1D (115mm.)			1H (135mm.)																
1E (120mm.)						1I (140mm.)													
1F (125mm.)							1J (145mm.)												
1G (130mm.)											NEW*								
1H (135mm.)	Z																		
1I (140mm.)		-																	
1J (145mm.)			-																

Measures

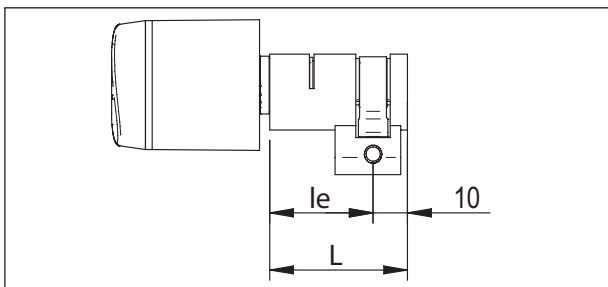

* This option has an additional price, please refer to the cylinder options chapter.
¹ Wireless version not available.
² LEGIC Cylinder can be slightly different
 M5 x 75mm screw included.

Profile cylinder

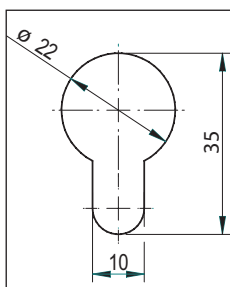

Cams

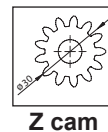
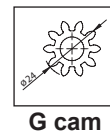
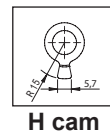

Knob Type

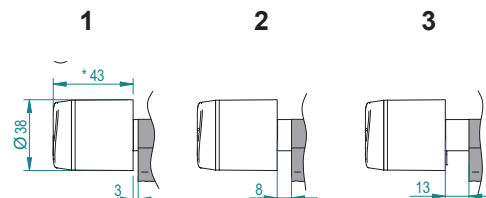

Model GxH1x	SALTO GEO Swiss profile half electronic cylinder One knob, no thumbturn. (Can be programmed as Selfprogrammable, ROM or RW cylinders)
--------------------	---

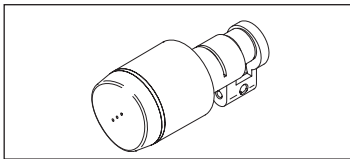

Prices - Gross prices		€
LEGIC <small>advant innovation in ID technology</small>	LEGIC advant: Standard - standard length, cam and finish.	393,05
MIFARE DESFire	Mifare DESFire: Standard - standard length, standard cams, standard finish.	393,05
	Mifare DESFire: Wireless - standard length, standard cams, standard finish.	528,75
iCLASS <small>by HID</small>	HID iCLASS: Standard - standard length, cam and finish.	541,40
	HID iCLASS: Wireless - standard length, cam and finish.	677,10

Additional Prices - Gross prices

Water resistance

Ref	Remarks	€
R	Water resistant (IP66)	16,90

Certification

Ref	Remarks	€
G	SKG*** compliant (IP66)	33,90
V	VDS - Bz+ (SKG***) compliant (IP66)	33,90

Finish options

Finish options		€
Satin Chromiun	G x x x x x x x CS x x x	0,00
Polished Chromiun	G x x x x x x x CP x x x	0,00
PVD Bright brass type	G x x x x x x x PP x x x	5,50
PVD Satin brass type	G x x x x x x x PM x x x	5,50
BioCoted Satin Chromiun	G x x x x x x x BC x x x	40,80
Satin Chromiun Black	G x x x x x x x NE x x x	8,65

Length options

L(mm) Total	Remarks	€
40mm up to 60mm		0,00
from 65mm up to 100mm		20,60
length over 100 mm		Upon request

Model GxH2x

SALTO GEO Swiss profile electronic cylinder
 Standard cylinder, one knob, one thumbturn.
 (Can be programmed as Selfprogrammable, ROM or RW cylinders)

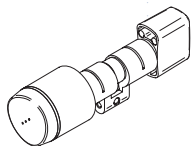

Technology	Model	Knob type	Outside length	Thumbturn	Inside length	Finish	Cams	Wireless	Certification	Water resistance	
G8 ^{1,2} LEGIC advant	H2	1 Removable Knob	30	S Standard	10	CSB	H	-	-	-	
			35		30						CPB
			40		35						
			45		40	PPB*					
			50		45						
			55		50						
G9 Mifare DESFire		2 Removable Knob 5mm plug	60	60	PMB*						
			65	65							
			70	.	BCB BioCote*						
			75								
			95		NEB*						
			1A (100mm.)								
GH HID iCLASS	3 Removable Knob 10mm plug	1B (105mm.)	1C (110mm.)	CSW							
		1C (110mm.)	1D (115mm.)								
		1D (115mm.)	1E (120mm.)	CPW							
		1E (120mm.)	1F (125mm.)								
		1F (125mm.)	1G (130mm.)	PPW*							
		1G (130mm.)	1H (135mm.)								
		1H (135mm.)	1I (140mm.)	PMW*							
		1I (140mm.)	1J (145mm.)								
		1J (145mm.)	1K (150mm.)	NEW*							

Measures

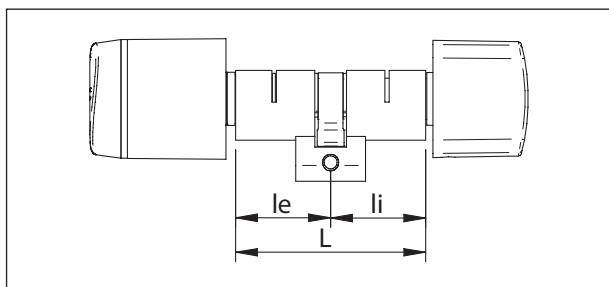

* This option has an additional price, please refer to the cylinder options chapter.
¹ Wireless version not available.
² LEGIC Cylinder can be slightly different
 M5 x 75mm screw included.

Profile cylinder

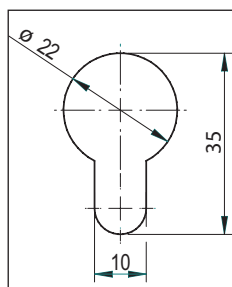

Cams

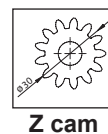
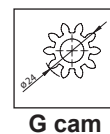
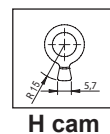

Knob Type

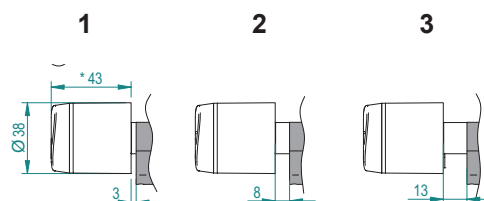

Model GxH2x	SALTO GEO Swiss profile electronic cylinder Standard cylinder, one knob, one thumbturn. (Can be programmed as Selfprogrammable, ROM or RW cylinders)
--------------------	--

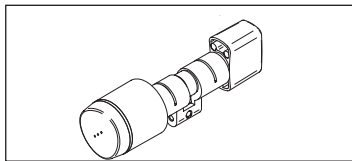

Prices - Gross prices		€
LEGIC <small>advant innovation in ID technology</small>	LEGIC advant: Standard - standard length, cam and finish.	404,40
MIFARE DESFire	Mifare DESFire: Standard - standard length, standard cams, standard finish.	404,40
	Mifare DESFire: Wireless - standard length, standard cams, standard finish.	540,15
iCLASS <small>by HID</small>	HID iCLASS: Standard - standard length, cam and finish.	552,95
	HID iCLASS: Wireless - standard length, cam and finish.	688,50

Additional Prices - Gross prices

Water resistance

Ref	Remarks	€
R	Water resistant (IP66)	16,90

Certification

Ref	Remarks	€
G	SKG*** compliant (IP66)	33,90
V	VDS - Bz+ (SKG***) compliant (IP66)	33,90

Finish options

Finish options		€
Satin Chromiun	G x x x x x x CS x x x	0,00
Polished Chromiun	G x x x x x x CP x x x	0,00
PVD Bright brass type	G x x x x x x PP x x x	5,50
PVD Satin brass type	G x x x x x x PM x x x	5,50
BioCoted Satin Chromiun	G x x x x x x BC x x x	40,80
Satin Chromiun Black	G x x x x x x NE x x x	8,65

Length options

L(mm) Total	Remarks	€
40mm up to 80mm		0,00
from 85mm up to 100mm		20,60
from 105 mm up to 120 mm		54,85
from 125 mm up to 145 mm		109,60
length over 150 mm		Upon request

Thumbturns

Thumbturns		€
S		0,00
R		6,90

Model GxH2xK

SALTO GEO Swiss profile electronic cylinder
AMOK cylinder, one knob, one thumbturn.
(Can be programmed as Selfprogrammable, ROM or RW cylinders)

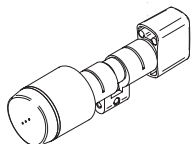

Technology	Model	Knob type	Outside length	Thumbturn	Inside length	Finish	Cams	Wireless	Panic function	Certification	Water resistance	
G8 ^{1,2} LEGIC advant	H2	1 Removable Knob	30	S Standard	35	CSB	H	-	-	-	-	
			35			K						
			40									CPB
			45									PPB*
			50									PMB*
			55									W Wireless online
60		R* Round										
2 Removable Knob 5mm plug			65	55	BCB BioCote*							
			70	60	NEB*							
			75	65	AMOK Function							
			95	70		No certification						
			1A -100mm.	75								-
	1B-105mm.	75	R* IP66									
1C-110mm.	95											
1D-115mm.	1A -100mm.	CPW										
1E-120mm.	1B-105mm.	CSW										
1F-125mm.		PMW*										
1G-130mm.		NEW*										
1H-135mm.												
1I-140mm.												
1J-145mm.												
G9 Mifare DESFire												
GH HID iCLASS												

Measures

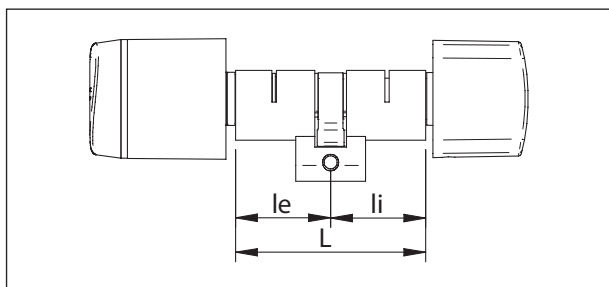

* This option has an additional price, please refer to the cylinder options chapter.
¹ Wireless version not available.
² LEGIC Cylinder can be slightly different

M5 x 75mm screw included.

Profile cylinder

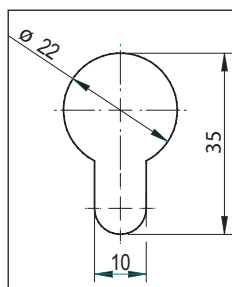

Cams

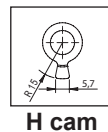

Knob Type

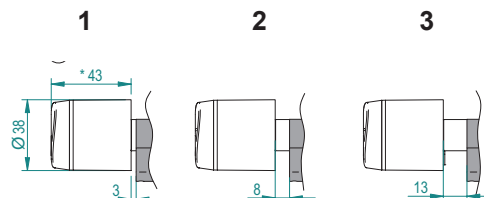

Model GxH2xK

SALTO GEO Swiss profile electronic cylinder
AMOK cylinder, one knob, one thumbturn.
(Can be programmed as Selfprogrammable, ROM or RW cylinders)

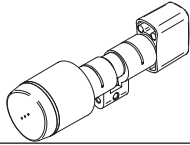

Prices - Gross prices

€



LEGIC advant: Standard - standard length, cam and finish.

507,70



Mifare DESFire: Standard - standard length, standard cams, standard finish.

507,70

Mifare DESFire: Wireless - standard length, standard cams, standard finish.

643,35



HID iCLASS: Standard - standard length, cam and finish.

656,10

HID iCLASS: Wireless - standard length, cam and finish.

791,75

Additional Prices - Gross prices

Water resistance

Ref	Remarks	€
R	Water resistant (IP66)	16,90

Finish options

€

Satin Chromiun	G x x x x x x CS x x x	0,00
Polished Chromiun	G x x x x x x CP x x x	0,00
PVD Bright brass type	G x x x x x x PP x x x	5,50
PVD Satin brass type	G x x x x x x PM x x x	5,50
BioCoted Satin Chromiun	G x x x x x x BC x x x	40,80
Satin Chromiun Black	G x x x x x x NE x x x	8,65

Length options

L(mm) Total	Remarks	€
40mm up to 80mm		0,00
from 85mm up to 100mm		20,60
from 105 mm up to 120 mm		54,85
from 125 mm up to 145 mm		109,60
length over 150 mm		Upon request

Thumbturns

€

S		0,00
R		6,90

<h3>Model GxH3x</h3>	<p>SALTO GEO Swiss profile electronic double cylinder Standard cylinder, two knob. (Can be programmed as Selfprogrammable, ROM or RW cylinders)</p>
----------------------	---

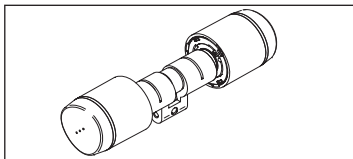

Technology	Model	Knob type	Outside length	Thumbturn	Inside length	Finish	Cams	Wireless	Certification	Water resistance			
G8 ^{1,2} LEGIC advant	H3	1 Removable Knob	30	N No thumbturn	30	CSB	H	-	-	-			
			35		35						CPB		
			40		40	PPB*							
			45		45						PMB*		
			50		50	BCB BioCote*							
			55		60						NEB*		
			60		65	G							
65		70	W Wireless online										
70		75			G*								
75		95									SKG*** (IP66)		
95		1A (100mm.)										R*	
1A (100mm.)		1B (105mm.)											IP66
1B (105mm.)		1C (110mm.)											
1C (110mm.)		1D (115mm.)											
1D (115mm.)	1E (120mm.)												
1E (120mm.)	1F (125mm.)												
1F (125mm.)	1G (130mm.)												
1G (130mm.)	1H (135mm.)												
1H (135mm.)	1I (140mm.)												
1I (140mm.)	1J (145mm.)												
1J (145mm.)	1K (150mm.)												
1K (150mm.)													
G9 Mifare DESFire	H3	2 ³ Removable Knob 5mm plug	65	N No thumbturn	65	CSW	G	-	-	-			
			70		70						CPW		
			75		75	PPW*							
			95		95						PMW*		
			1A (100mm.)		1B (105mm.)	NEW*							
			1B (105mm.)		1C (110mm.)						Z		
			1C (110mm.)		1D (115mm.)	W Wireless online							
1D (115mm.)		1E (120mm.)	G*										
1E (120mm.)		1F (125mm.)			SKG*** (IP66)								
1F (125mm.)		1G (130mm.)										R*	
1G (130mm.)		1H (135mm.)											IP66
1H (135mm.)		1I (140mm.)											
1I (140mm.)		1J (145mm.)											
1J (145mm.)		1K (150mm.)											
1K (150mm.)													
GH HID iCLASS	H3	3 ³ Removable Knob 10mm plug	65	N No thumbturn	65	CSW	G	-	-	-			
			70		70						CPW		
			75		75	PPW*							
			95		95						PMW*		
			1A (100mm.)		1B (105mm.)	NEW*							
			1B (105mm.)		1C (110mm.)						Z		
			1C (110mm.)		1D (115mm.)	W Wireless online							
1D (115mm.)		1E (120mm.)	G*										
1E (120mm.)		1F (125mm.)			SKG*** (IP66)								
1F (125mm.)		1G (130mm.)										R*	
1G (130mm.)		1H (135mm.)											IP66
1H (135mm.)		1I (140mm.)											
1I (140mm.)		1J (145mm.)											
1J (145mm.)		1K (150mm.)											
1K (150mm.)													

Measures

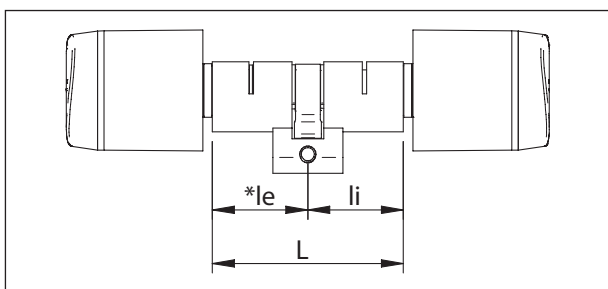

- * This option has an additional price, please refer to the cylinder options chapter.
 - ¹ Wireless version not available.
 - ² LEGIC Cylinder can be slightly different
 - ³ When used with double reader units, the knob type applies only to the external knob. Internal knob will always be "1"
- M5 x 75mm screw included.

Profile cylinder

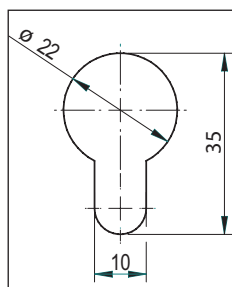

Cams

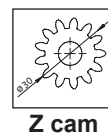
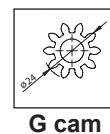
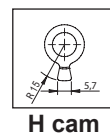

Knob Type

Only for outside knob.
Inside remains standard (3mm)

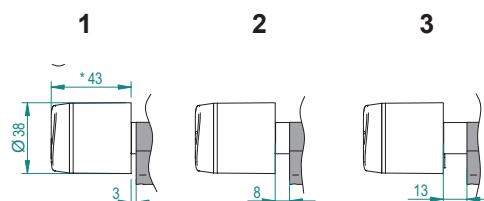

Model GxH3x	SALTO GEO Swiss profile electronic double cylinder Standard cylinder, two knob. (Can be programmed as Selfprogrammable, ROM or RW cylinders)
--------------------	--

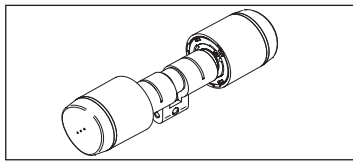

Prices - Gross prices		€
LEGIC <small>advant innovation in ID technology</small>	LEGIC advant: Standard - standard length, cam and finish.	495,70
MIFARE DESFire	Mifare DESFire: Standard - standard length, standard cams, standard finish.	495,70
	Mifare DESFire: Wireless - standard length, standard cams, standard finish.	631,40
iCLASS <small>HID</small>	HID iCLASS: Standard - standard length, cam and finish.	644,15
	HID iCLASS: Wireless - standard length, cam and finish.	779,90

Additional Prices - Gross prices

Water resistance

Ref	Remarks	€
R	Water resistant (IP66)	16,90

Certification

Ref	Remarks	€
G	SKG*** compliant (IP66)	33,90
V	VDS - Bz+ (SKG***) compliant (IP66)	33,90

Finish options

Finish options		€
Satin Chromiun	G x x x x x x CS x x x	0,00
Polished Chromiun	G x x x x x x CP x x x	0,00
PVD Bright brass type	G x x x x x x PP x x x	5,50
PVD Satin brass type	G x x x x x x PM x x x	5,50
BioCoted Satin Chromiun	G x x x x x x BC x x x	40,80
Satin Chromiun Black	G x x x x x x NE x x x	8,65

Length options

L(mm) Total	Remarks	€
40mm up to 80mm		0,00
from 85mm up to 100mm		20,60
from 105 mm up to 120 mm		54,85
from 125 mm up to 145 mm		109,60
length over 150 mm		Upon request

Model GxS1x

SALTO GEO Scandinavian profile electronic cylinder
Exterior cylinder, one knob, no thumbturn.
(Can be programmed as Selfprogrammable, ROM or RW cylinders)

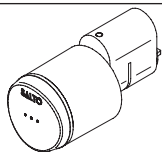

Technology	Model	Knob type	Outside length	Thumbturn	Inside length	Finish	Cams	Wireless	Certification	Water resistance
G8 ^{1,2} LEGIC advant	S1	1 Removable Knob	30	N No thumbturn	00 10mm	CSB	N No applicable	-	-	-
						CPB				
						PPB*				
PMB*										
BCB BioCote*										
NEB*										
CSW										
CPW										
PPW*										
PMW*										
NEW*										
G9 Mifare DESFire	S1	1 Removable Knob	30	N No thumbturn	00 10mm	CSB	N No applicable	-	-	-
CPB										
PPB*										
PMB*										
BCB BioCote*										
NEB*										
CSW										
CPW										
PPW*										
PMW*										
NEW*										
GH HID iCLASS	S1	1 Removable Knob	30	N No thumbturn	00 10mm	CSB	N No applicable	W Wireless online	G* SKG*** (IP66)	R* IP66
CPB										
PPB*										
PMB*										
BCB BioCote*										
NEB*										
CSW										
CPW										
PPW*										
PMW*										
NEW*										

Measures

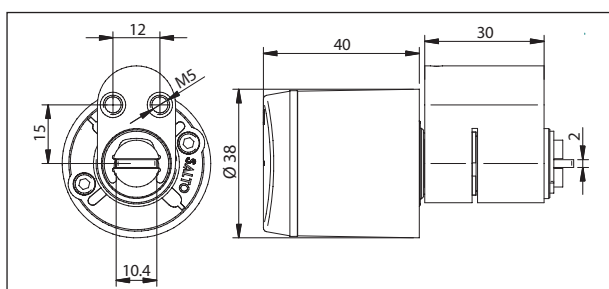

* This option has an additional price, please refer to the cylinder options chapter.
¹ Wireless version not available.
² LEGIC Cylinder can be slightly different

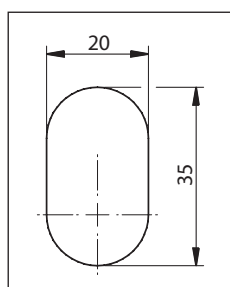

Requires assembly from the inside.
Please consult SALTO for more information.

Profile cylinder

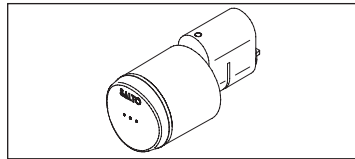

Model GxS1x	SALTO GEO Scandinavian profile electronic cylinder Exterior cylinder, one knob, no thumbturn. (Can be programmed as Selfprogrammable, ROM or RW cylinders)
--------------------	--



Prices - Gross prices		€
	LEGIC advant: Standard - standard length, cam and finish.	406,80
	Mifare DESFire: Standard - standard length, standard cams, standard finish.	406,80
	Mifare DESFire: Wireless - standard length, standard cams, standard finish.	528,75
	HID iCLASS: Standard - standard length, cam and finish.	555,15
	HID iCLASS: Wireless - standard length, cam and finish.	677,10

Additional Prices - Gross prices

Water resistance

Ref	Remarks	€
R	Water resistant (IP66)	16,90

Certification

Ref	Remarks	€
G	SKG*** compliant (IP66)	33,90
V	VDS - Bz+ (SKG***) compliant (IP66)	33,90

Finish options

Finish options		€
Satin Chromiun	G x x x x x x CS x x x	0,00
Polished Chromiun	G x x x x x x CP x x x	0,00
PVD Bright brass type	G x x x x x x PP x x x	5,50
PVD Satin brass type	G x x x x x x PM x x x	5,50
BioCoted Satin Chromiun	G x x x x x x BC x x x	40,80
Satin Chromiun Black	G x x x x x x NE x x x	8,65

Model GxS2x

SALTO GEO Scandinavian profile electronic cylinder
Interior cylinder, one knob, no thumbturn.
(Can be programmed as Selfprogrammable, ROM or RW cylinders)

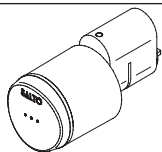

Technology	Model	Knob type	Outside length	Thumbturn	Inside length	Finish	Cams	Wireless	Certification	Water resistance
G8 ^{1,2} LEGIC advant	S2	1 Removable Knob	30	N No thumbturn	00 10mm	CSB	N No applicable	-	-	-
						CPB				
						PPB*				
						PMB*				
G9 Mifare DESFire	S2	1 Removable Knob	30	N No thumbturn	00 10mm	BCB BioCote*	N No applicable	-	-	-
						NEB*				
						CSW				
GH HID iCLASS	S2	1 Removable Knob	30	N No thumbturn	00 10mm	CPW	N No applicable	W Wireless online	G* SKG*** (IP66)	R* IP66
						PPW*				
						PMW*				
						NEW*				

Measures

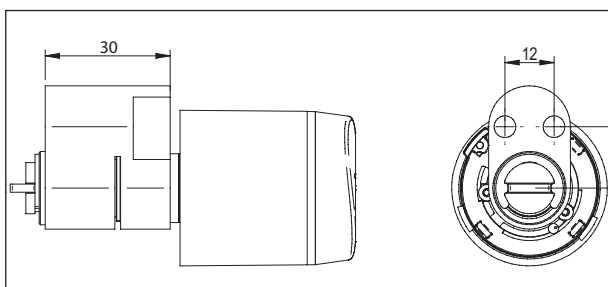

* This option has an additional price, please refer to the cylinder options chapter.
¹ Wireless version not available.
² LEGIC Cylinder can be slightly different

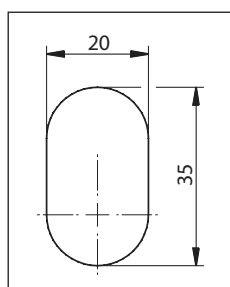

Requires assembly from the inside.
Please consult SALTO for more information.

Profile cylinder

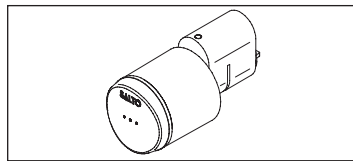

Model GxS2x	SALTO GEO Scandinavian profile electronic cylinder Interior cylinder, one knob, no thumbturn. (Can be programmed as Selfprogrammable, ROM or RW cylinders)
--------------------	--



Prices - Gross prices		€
 LEGIC <small>advant innovation in ID technology</small>	LEGIC advant: Standard - standard length, cam and finish.	406,80
	Mifare DESFire: Standard - standard length, standard cams, standard finish.	406,80
	Mifare DESFire: Wireless - standard length, standard cams, standard finish.	528,75
	HID iCLASS: Standard - standard length, cam and finish.	555,15
	HID iCLASS: Wireless - standard length, cam and finish.	677,10

Additional Prices - Gross prices

Water resistance

Ref	Remarks	€
R	Water resistant (IP66)	16,90

Certification

Ref	Remarks	€
G	SKG*** compliant (IP66)	33,90
V	VDS - Bz+ (SKG***) compliant (IP66)	33,90

Finish options

		€
Satin Chromiun	G x x x x x x CS x x x	0,00
Polished Chromiun	G x x x x x x CP x x x	0,00
PVD Bright brass type	G x x x x x x PP x x x	5,50
PVD Satin brass type	G x x x x x x PM x x x	5,50
BioCoted Satin Chromiun	G x x x x x x BC x x x	40,80
Satin Chromiun Black	G x x x x x x NE x x x	8,65

Model GxS3x

SALTO GEO Scandinavian profile electronic cylinder
Security cylinder, one knob, no thumbturn.
(Can be programmed as Selfprogrammable, ROM or RW cylinders)

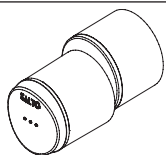

Technology	Model	Knob type	Outside length	Thumbturn	Inside length	Finish	Cams	Wireless	Certification	Water resistance
G8 ^{1,2} LEGIC advant	S3	1 Removable Knob	30	N No thumbturn	00 10mm	CSB	N No applicable	-	-	-
						CPB				
						PPB*				
						PMB*				
BCB BioCote*										
NEB*										
CSW										
CPW										
PPW*										
PMW*										
NEW*										
G9 Mifare DESFire	S3	1 Removable Knob	30	N No thumbturn	00 10mm	CSB	N No applicable	-	-	-
CPB										
PPB*										
PMB*										
BCB BioCote*										
NEB*										
CSW										
CPW										
PPW*										
PMW*										
NEW*										
GH HID iCLASS	S3	1 Removable Knob	30	N No thumbturn	00 10mm	CSB	N No applicable	W Wireless online	G* SKG*** (IP66)	R* IP66
CPB										
PPB*										
PMB*										
BCB BioCote*										
NEB*										
CSW										
CPW										
PPW*										
PMW*										
NEW*										

Measures

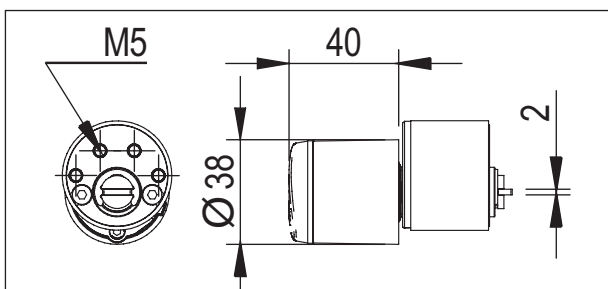

* This option has an additional price, please refer to the cylinder options chapter.
¹ Wireless version not available.
² LEGIC Cylinder can be slightly different

M5 x 45 screw included.

Requires assembly from the inside.
Please consult SALTO for more information.

Profile cylinder

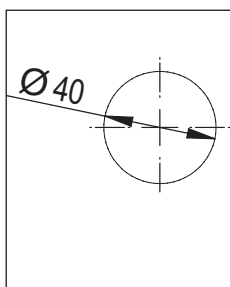

Model GxS3x	SALTO GEO Scandinavian profile electronic cylinder Security cylinder, one knob, no thumbturn. (Can be programmed as Selfprogrammable, ROM or RW cylinders)
--------------------	--

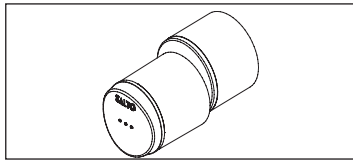

Prices - Gross prices		€
LEGIC advant: Standard - standard length, cam and finish.		455,40
Mifare DESFire: Standard - standard length, standard cams, standard finish.		455,40
Mifare DESFire: Wireless - standard length, standard cams, standard finish.		591,05
HID iCLASS: Standard - standard length, cam and finish.		603,85
HID iCLASS: Wireless - standard length, cam and finish.		739,55

Additional Prices - Gross prices

Water resistance

Ref	Remarks	€
R	Water resistant (IP66)	16,90

Certification

Ref	Remarks	€
G	SKG*** compliant (IP66)	33,90
V	VDS - Bz+ (SKG***) compliant (IP66)	33,90

Finish options

Finish options		€
Satin Chromiun	G x x x x x x CS x x x	0,00
Polished Chromiun	G x x x x x x CP x x x	0,00
PVD Bright brass type	G x x x x x x PP x x x	5,50
PVD Satin brass type	G x x x x x x PM x x x	5,50
BioCoted Satin Chromiun	G x x x x x x BC x x x	40,80
Satin Chromiun Black	G x x x x x x NE x x x	8,65



Accessories Ring - Prices - Gross prices

Reference	Finish	€
SP220874-IM	Satin Stainless Steel (US32D)	28,55
SP220874-IM for cylinder finishes CSB and CPB		28,55
SP220874-PM	PVD Satin Brass Type (US3D)	35,65
SP220874-PM for cylinder finishes PPB and PMB		35,65

Model GxK1x

SALTO GEO RIM UK profile electronic cylinder.
 Exterior cylinder, one knob, no thumbturn.
 (Can be programmed as Selfprogrammable, ROM or RW cylinders)

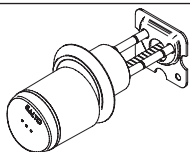

Technology	Model	Knob type	Outside length	Thumbturn	Inside length	Finish	Cams	Wireless	Certification	Water resistance
G8 ^{1,2} LEGIC advant	K1	1 Removable Knob	00	N No thumbturn	00 Not applicable	CSB	N No applicable	-	-	-
						CPB				
						PPB*				
						PMB*				
BCB BioCote*										
NEB*										
CSW										
CPW										
PPW*										
PMW*										
NEW*										
G9 Mifare DESFire	K1	1 Removable Knob	00	N No thumbturn	00 Not applicable	CSB	N No applicable	-	-	-
CPB										
PPB*										
PMB*										
BCB BioCote*										
NEB*										
CSW										
CPW										
PPW*										
PMW*										
NEW*										
GH HID iCLASS	K1	1 Removable Knob	00	N No thumbturn	00 Not applicable	CSB	N No applicable	W Wireless online	G* SKG*** (IP66)	R* IP66
CPB										
PPB*										
PMB*										
BCB BioCote*										
NEB*										
CSW										
CPW										
PPW*										
PMW*										
NEW*										

Measures

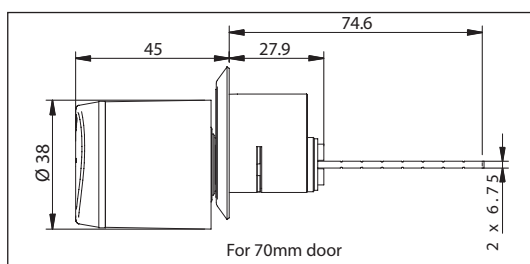

- * This option has an additional price, please refer to the cylinder options chapter.
- ¹ Wireless version not available.
- ² LEGIC Cylinder can be slightly different

Standard ring, backplate and M5 x 45 screw included.
 For SKG*** an SKG*** ring must be installed with the cylinder.

Requires assembly from the inside.
Please consult SALTO for more information.

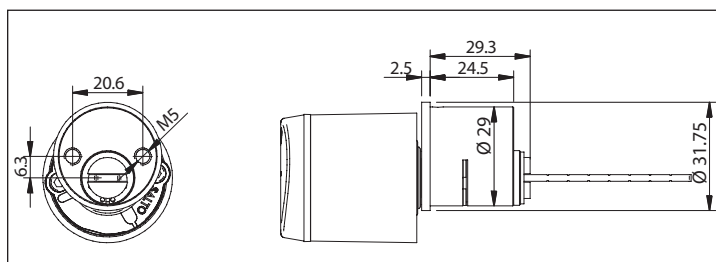
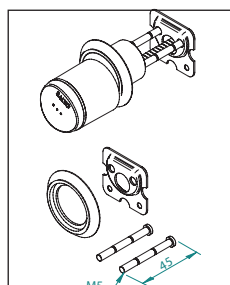

Model GxK1x	SALTO GEO RIM UK profile electronic cylinder. Exterior cylinder, one knob, no thumbturn. (Can be programmed as Selfprogrammable, ROM or RW cylinders)
--------------------	---

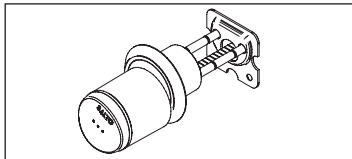

Prices - Gross prices	€
------------------------------	---

	LEGIC advant: Standard - standard length, cam and finish.	413,35
	Mifare DESFire: Standard - standard length, standard cams, standard finish.	413,35
	Mifare DESFire: Wireless - standard length, standard cams, standard finish.	549,00
	HID iCLASS: Standard - standard length, cam and finish.	561,90
	HID iCLASS: Wireless - standard length, cam and finish.	697,55

Additional Prices - Gross prices

Water resistance

Ref	Remarks	€
R	Water resistant (IP66)	16,90

Certification

Ref	Remarks	€
G	SKG*** compliant (IP66)	33,90
V	VDS - Bz+ (SKG***) compliant (IP66)	33,90

Finish options

		€
Satin Chromiun	G x x x x x x CS x x x	0,00
Polished Chromiun	G x x x x x x CP x x x	0,00
PVD Bright brass type	G x x x x x x PP x x x	5,50
PVD Satin brass type	G x x x x x x PM x x x	5,50
BioCoted Satin Chromiun	G x x x x x x BC x x x	40,80
Satin Chromiun Black	G x x x x x x NE x x x	8,65

Model GxB1x

SALTO GEO RIM USA profile electronic cylinder.
Exterior cylinder, one knob, no thumbturn.
(Can be programmed as Selfprogrammable, ROM or RW cylinders)

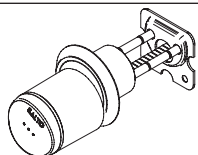

Technology	Model	Knob type	Outside length	Thumbturn	Inside length	Finish	Cams	Wireless	Certification	Water resistance
G8 ^{1,2} LEGIC advant	B1	1 Removable Knob	00	N No thumbturn	00 Not applicable	CSB	N No applicable	-	No Certification	-
						CPB				
						PPB*				
						PMB*				
G9 Mifare DESFire	B1	1 Removable Knob	00	N No thumbturn	00 Not applicable	BCB BioCote*	N No applicable	-	No Certification	-
						NEB*				
						CSW				
GH HID iCLASS	B1	1 Removable Knob	00	N No thumbturn	00 Not applicable	CPW	N No applicable	W Wireless online	G* SKG*** (IP66)	R* IP66
						PPW*				
						PMW*				
						NEW*				

Measures

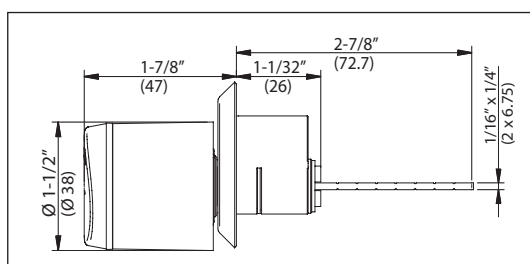

- * This option has an additional price, please refer to the cylinder options chapter.
- ¹ Wireless version not available.
- ² LEGIC Cylinder can be slightly different

Standard ring, backplate and 12-24UNC screw included.
For SKG*** an SKG*** ring must be installed with the cylinder.

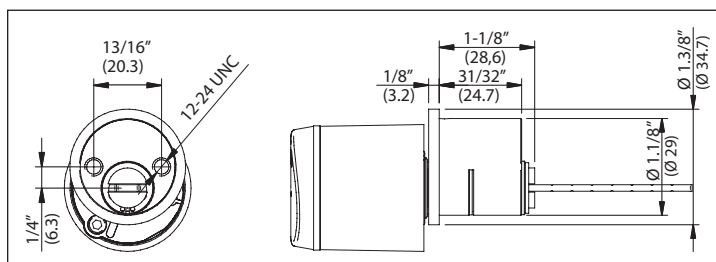
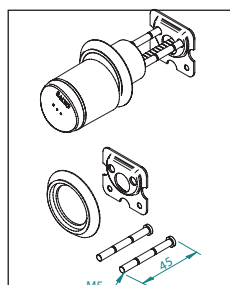

Requires assembly from the inside.
Please consult SALTO for more information.

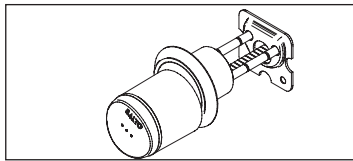

Model GxB1x	SALTO GEO RIM USA profile electronic cylinder. Exterior cylinder, one knob, no thumbturn. (Can be programmed as Selfprogrammable, ROM or RW cylinders)
--------------------	--



Prices - Gross prices	€
------------------------------	---

	LEGIC advant: Standard - standard length, cam and finish.	424,50
	Mifare DESFire: Standard - standard length, standard cams, standard finish.	424,50
	Mifare DESFire: Wireless - standard length, standard cams, standard finish.	560,15
	HID iCLASS: Standard - standard length, cam and finish.	573,00
	HID iCLASS: Wireless - standard length, cam and finish.	708,70

Additional Prices - Gross prices

Water resistance

Ref	Remarks	€
R	Water resistant (IP66)	16,90

Certification

Ref	Remarks	€
G	SKG*** compliant (IP66)	33,90
V	VDS - Bz+ (SKG***) compliant (IP66)	33,90

Finish options

		€
Satin Chromiun	G x x x x x x CS x x x	0,00
Polished Chromiun	G x x x x x x CP x x x	0,00
PVD Bright brass type	G x x x x x x PP x x x	5,50
PVD Satin brass type	G x x x x x x PM x x x	5,50
BioCoted Satin Chromiun	G x x x x x x BC x x x	40,80
Satin Chromiun Black	G x x x x x x NE x x x	8,65

Model GxB2x

SALTO GEO RIM USA profile electronic cylinder.
For Schlage® B-series deadbolt. Exterior cylinder, one knob, no thumbturn.
(Can be programmed as Selfprogrammable, ROM or RW cylinders)

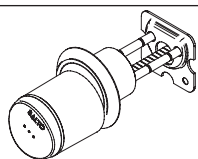

Technology	Model	Knob type	Outside length	Thumbturn	Inside length	Finish	Cams	Wireless	Certification	Water resistance
G8 ^{1,2} LEGIC advant	B2	1 Removable Knob	00	N No thumbturn	00 Not applicable	CSB	N No applicable	-	-	-
						CPB				
						PPB*				
						PMB*				
G9 Mifare DESFire	B2	1 Removable Knob	00	N No thumbturn	00 Not applicable	BCB BioCote*	N No applicable	-	-	-
						NEB*				
						CSW				
GH HID iCLASS	B2	1 Removable Knob	00	N No thumbturn	00 Not applicable	CPW	N No applicable	W Wireless online	-	-
						PPW*				
						PMW*				
						NEW*				

Measures

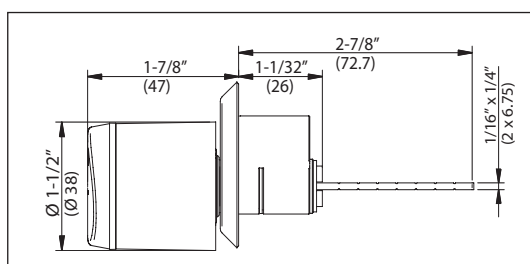

- * This option has an additional price, please refer to the cylinder options chapter.
- ¹ Wireless version not available.
- ² LEGIC Cylinder can be slightly different

Requires assembly from the inside.
Please consult SALTO for more information.

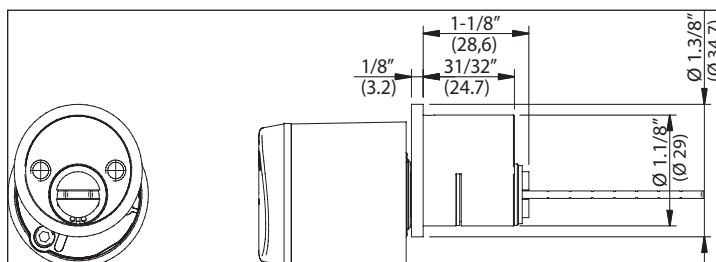
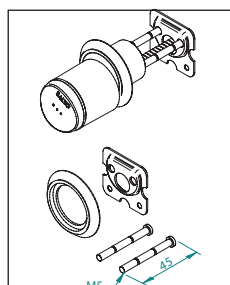

Model GxB2x

SALTO GEO RIM USA profile electronic cylinder.
For Schlage® B-series deadbolt. Exterior cylinder, one knob, no thumbturn.
(Can be programmed as Selfprogrammable, ROM or RW cylinders)

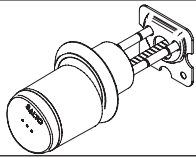

Prices - Gross prices

€



LEGIC advant: Standard - standard length, cam and finish.

424,50



Mifare DESFire: Standard - standard length, standard cams, standard finish.

424,50

Mifare DESFire: Wireless - standard length, standard cams, standard finish.

560,15



HID iCLASS: Standard - standard length, cam and finish.

573,00

HID iCLASS: Wireless - standard length, cam and finish.

708,70

Additional Prices - Gross prices

Water resistance

Ref	Remarks	€
R	Water resistant (IP66)	16,90

Finish options

€

		€
Satin Chromiun	G x x x x x x CS x x x	0,00
Polished Chromiun	G x x x x x x CP x x x	0,00
PVD Bright brass type	G x x x x x x PP x x x	5,50
PVD Satin brass type	G x x x x x x PM x x x	5,50
BioCoted Satin Chromiun	G x x x x x x BC x x x	40,80
Satin Chromiun Black	G x x x x x x NE x x x	8,65

Model GxB3x51

SALTO GEO Heavy duty deadbolt electronic cylinder.
To be used in combination with SALTO deadbolt LD51 or LD71series

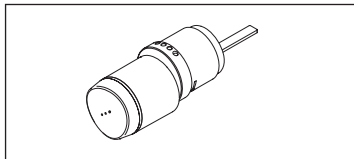

Technology	Model	Knob type	Function	Door thickness	Inside length	Finish	Cams	Wireless	Certification	Water resistance	
G8 ^{1,2} LEGIC advant	B3	1 Removable Knob	51	N Not applicable	00 Not applicable	CSB	N No applicable	-	-	-	
G9 Mifare DESFire						CPB					Standalone
						GH HID iCLASS		CSW			
						CPW		No Certification			

Measures

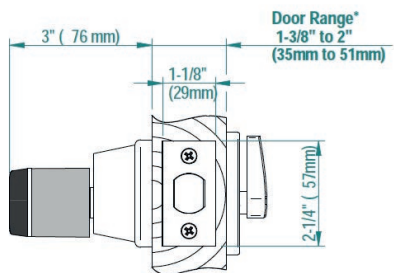

Deadbolt meet A156.36 Grade 1 requirements

* This option has an additional price, please refer to the cylinder options chapter.

¹ Wireless version not available.

² LEGIC Cylinder can be slightly different

SALTO Geo B3 cylinder can not be sold separately to the SALTO LD series deadbolt

Function	Illustration	Operations	ANSI number	Cylinder	Deadbolt
51 Single cylinder		Deadbolt operated by card form outside and by thumbturn from the inside Latch projected automatically	E2151		
71 classroom		Deadbolt operated by card form outside. Thumbturn retracts deadbolt but does not project it	E2171		

Model GxB3x51	SALTO GEO Heavy duty deadbolt electronic cylinder. To be used in combination with SALTO deadbolt LD51 or LD71series
----------------------	--

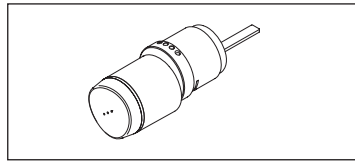

Prices - Gross prices		€
LEGIC advant: Standard - standard length, cam and finish.		424,50
Mifare DESFire: Standard - standard length, standard cams, standard finish.		424,50
Mifare DESFire: Wireless - standard length, standard cams, standard finish.		560,15
HID iCLASS: Standard - standard length, cam and finish.		573,00
HID iCLASS: Wireless - standard length, cam and finish.		708,70

Additional Prices - Gross prices

Water resistance

Ref	Remarks	€
R	Water resistant (IP66)	16,90

Finish options

		€
Satin Chromiun	G x x x x x x CS x x x	0,00
Polished Chromiun	G x x x x x x CP x x x	0,00
Satin Chromiun	G x x x x x x CS x x x	5,50
Polished Chromiun	G x x x x x x CP x x x	5,50

SALTO Deadbolt

Function	Illustration	Operations	Reference			€
			Product	Backset	Finish	
51 Single cylinder		Deadbolt operated by card form outside and by thumbturn from the inside. Latch projected automatically	LD51C	70 70mm (2-3/4")	CS Satin chromium	114,60
				60 60mm (2-3/8")		
71 classroom		Deadbolt operated by card form outside. Thumbturn retracts deadbolt but does not project it	LD71C	70 70mm (2-3/4")	CS Satin chromium	114,60
				60 60mm (2-3/8")		

Model GxB3x41	SALTO GEO Heavy duty deadbolt electronic double cylinder. To be used in combination with SALTO deadbolt LD41 series
----------------------	--

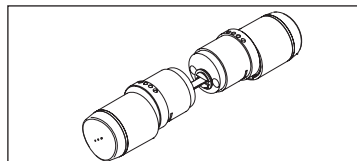

Technology	Model	Knob type	Function	Door thickness	Inside length	Finish	Cams	Wireless	Certification	Water resistance	
G8 ^{1,2} LEGIC advant	B3	1 Removable Knob	41	N No thumbturn	00 Not applicable	CSB	N No applicable	-	-	-	
G9 Mifare DESFire						CPB					Standalone
						CSW		W Wireless online			
GH HID iCLASS	CPW	No Certification									

Measures

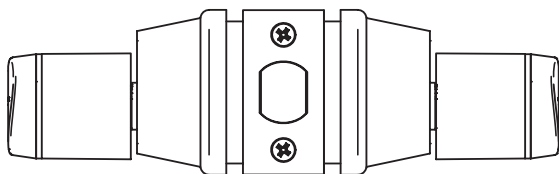

Deadbolt meet A156.36 Grade 1 requirements

* This option has an additional price, please refer to the cylinder options chapter.

¹ Wireless version not available.

² LEGIC Cylinder can be slightly different

SALTO Geo B3 cylinder can not be sold separately to the SALTO LD series deadbolt

Function	Illustration	Operations	ANSI number	Cylinder	Deadbolt
41 Double cylinder		Deadbolt operated by card from either side	E2141	GIB3141N00CSBN 	LD41C70CS

Model GxB3x41	SALTO GEO Heavy duty deadbolt electronic double cylinder. To be used in combination with SALTO deadbolt LD41 series
----------------------	--

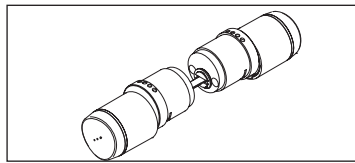

Prices - Gross prices		€
LEGIC advant: Standard - standard length, cam and finish.		849,10
Mifare DESFire: Standard - standard length, standard cams, standard finish.		849,10
Mifare DESFire: Wireless - standard length, standard cams, standard finish.		1120,35
HID iCLASS: Standard - standard length, cam and finish.		997,50
HID iCLASS: Wireless - standard length, cam and finish.		1268,85

Additional Prices - Gross prices

Water resistance

Ref	Remarks	€
R	Water resistant (IP66)	16,90

Finish options

		€
Satin Chromiun	G x x x x x x CS x x x	0,00
Polished Chromiun	G x x x x x x CP x x x	0,00
PVD Bright brass type	G x x x x x x PP x x x	5,50
PVD Satin brass type	G x x x x x x PM x x x	5,50

Certification

Ref	Remarks	€

SALTO Deadbolt

Function	Illustration	Operations	Reference			€
			Product	Backset	Finish	
41 Double cylinder		Deadbolt operated by card from either side	LD41C	70 70mm (2-3/4")	CS Satin chromium	161,85
				60 60mm (2-3/8")		

Model GxM1x	SALTO GEO Mortise profile electronic cylinder Exterior cylinder, one knob, no thumbturn. (Can be programmed as Selfprogrammable, ROM or RW cylinders)
--------------------	---

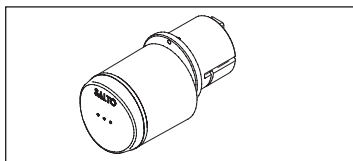

Technology	Model	Knob type	Outside length	Thumbturn	Inside length	Finish	Cams	Wireless	Certification	Water resistance							
G8 ^{1,2} LEGIC advant	M1	1 Removable Knob	32	N No thumbturn	00 Not appli- cable	CSB	N No applicable	-	-	-							
			35			CPB											
			38			PPB*											
41			PMB*														
44			BCB BioCote*														
50			NEB*														
G9 Mifare DESFire			CSW			CPW					PPW*	PMW*	NEW*	W Wireless online	-	No Certifica- tion	R* IP66

Measures

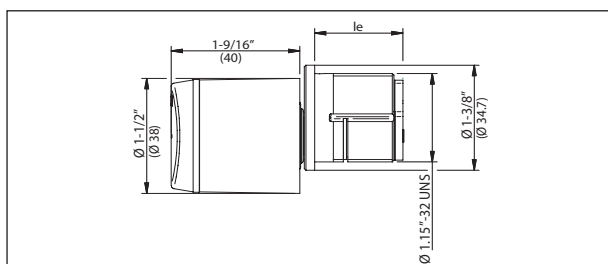

* This option has an additional price, please refer to the cylinder options chapter.
¹ Wireless version not available.
² LEGIC Cylinder can be slightly different

Requires assembly from the inside.
Please consult SALTO for more information.

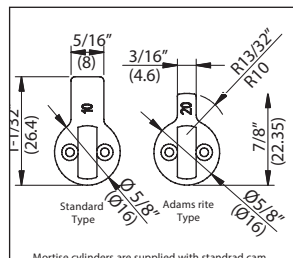

Mortise cylinders are supplied with standard cam. Adams Rite type also included

The following cams are also compatible to mount on SALTO GEO mortise cylinder MEDECO, YALE, MARKS ILCO (not sold by SALTO).

Length options Additional Prices - Gross prices

SERIE	le (mm)	le (inches)	Remarks	€
G9M1032	32	1-1/4"		0,00
G9M1035	35	1-3/8"		
G9M1038	38	1-1/2"		20,90
G9M1041	41	1-5/8"		
G9M1044	44	1-3/4"		34,75
G9M1050	50	2"		

Installation tool for mortise cylinders

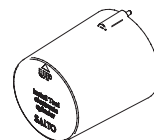

Reference	€
SP220412	1,30



Spring included.

Model GxM1x	SALTO GEO Mortise profile electronic cylinder Exterior cylinder, one knob, no thumbturn. (Can be programmed as Selfprogrammable, ROM or RW cylinders)
--------------------	---

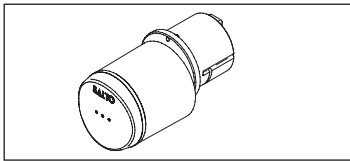

Prices - Gross prices		€
LEGIC advant: Standard - standard length, cam and finish.		413,35
Mifare DESFire: Standard - standard length, standard cams, standard finish.		413,35
Mifare DESFire: Wireless - standard length, standard cams, standard finish.		549,00
HID iCLASS: Standard - standard length, cam and finish.		561,90
HID iCLASS: Wireless - standard length, cam and finish.		697,55

Additional Prices - Gross prices

Water resistance		€	Finish options		€
Ref	Remarks	€	Satin Chromiun	G x x x x x x CS x x x	0,00
R	Water ressistant (IP66)	16,90	Polished Chromiun	G x x x x x x CP x x x	0,00
Certification			PVD Bright brass type	G x x x x x x PP x x x	5,50
Ref	Remarks	€	PVD Satin brass type	G x x x x x x PM x x x	5,50
			BioCoted Satin Chromiun	G x x x x x x BC x x x	40,80
			Satin Chromiun Black	G x x x x x x NE x x x	8,65

Ring	Reference	B	Finish	€
<p>SP220418 ring for mortise cylinders</p>	SP220418.38-IM	3/8" (9.5 mm)	Satin Stainless Steel (US32D)	14,30
	SP220418.38-IM for cylinder finishes CSB and CPB			
	SP220418.38-PM	3/8" (9.5 mm)	PVD Satin Brass Type (US3D)	20,25
	SP220418.38-PM for cylinder finishes PPB and PMB			
	SP220418.12-IM	1/2" (12.7 mm)	Satin Stainless Steel (US32D)	14,30
	SP220418.12-IM for cylinder finishes CSB and CPB			
	SP220418.12-PM	1/2" (12.7 mm)	PVD Satin Brass Type (US3D)	20,25
SP220418.12-IM for cylinder finishes CSB and CPB				
<p>SP220646 ring for mortise cylinders</p>	Reference	B	Finish	€
	SP220646-IM	3/8" (9.5 mm)	Satin Stainless Steel (US32D)	14,30
	SP220646-IM for cylinder finishes CSB and CPB			
	SP220646-PM	3/8" (9.5 mm)	PVD Satin Brass Type (US3D)	20,25
SP220646-PM for cylinder finishes PPB and PMB				

Model GxA1x

SALTO GEO Australian oval profile electronic cylinder
Exterior cylinder, one knob, no thumbturn.
(Can be programmed as Selfprogrammable, ROM or RW cylinders)

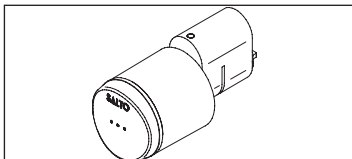

Technology	Model	Knob type	Outside length	Thumbturn	Inside length	Finish	Cams	Wireless	Certification	Water resistance
G8 ^{1,2} LEGIC advant	A1	1 Removable Knob	00	N No thumbturn	00 Not appli- cable	CSB	N No applicable	-	-	-
						CPB				
						PPB*				
						PMB*				
G9 Mifare DESFire	A1	1 Removable Knob	00	N No thumbturn	00 Not appli- cable	BCB BioCote*	N No applicable	-	-	-
						NEB*				
						CSW				
GH HID iCLASS	A1	1 Removable Knob	00	N No thumbturn	00 Not appli- cable	CPW	N No applicable	W Wireless online	G* SKG*** (IP66)	R* IP66
						PPW*				
						PMW*				
						NEW*				

Measures

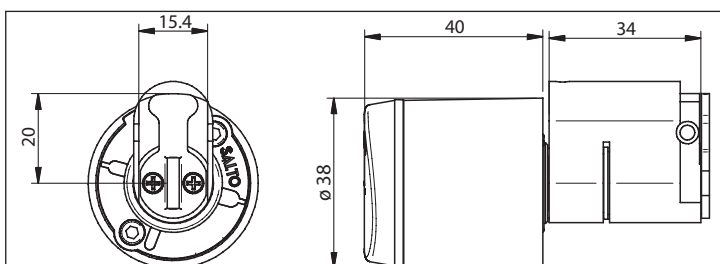

* This option has an additional price, please refer to the cylinder options chapter.
¹ Wireless version not available.
² LEGIC Cylinder can be slightly different

Requires assembly from the inside.
Please consult SALTO for more information.

Profile cylinder

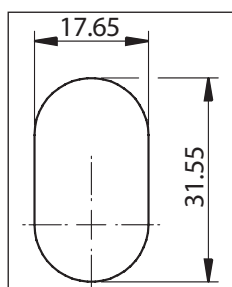

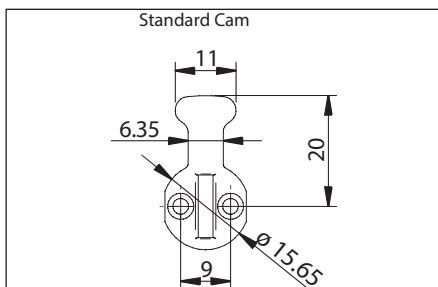

Cams

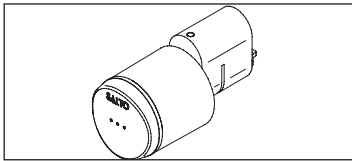

Model GxA1x	SALTO GEO Australian oval profile electronic cylinder Exterior cylinder, one knob, no thumbturn. (Can be programmed as Selfprogrammable, ROM or RW cylinders)
--------------------	---



Prices - Gross prices	€
------------------------------	---

	LEGIC advant: Standard - standard length, cam and finish.	406,80
	Mifare DESFire: Standard - standard length, standard cams, standard finish.	406,80
	Mifare DESFire: Wireless - standard length, standard cams, standard finish.	528,75
	HID iCLASS: Standard - standard length, cam and finish.	555,15
	HID iCLASS: Wireless - standard length, cam and finish.	677,10

Additional Prices - Gross prices

Water resistance

Ref	Remarks	€
R	Water resistant (IP66)	16,90

Certification

Ref	Remarks	€
G	SKG*** compliant (IP66)	33,90
V	VDS - Bz+ (SKG***) compliant (IP66)	33,90

Finish options

		€
Satin Chromiun	G x x x x x x x CS x x x	0,00
Polished Chromiun	G x x x x x x x CP x x x	0,00
PVD Bright brass type	G x x x x x x x PP x x x	5,50
PVD Satin brass type	G x x x x x x x PM x x x	5,50
BioCoted Satin Chromiun	G x x x x x x x BC x x x	40,80
Satin Chromiun Black	G x x x x x x x NE x x x	8,65

Model GxP2x

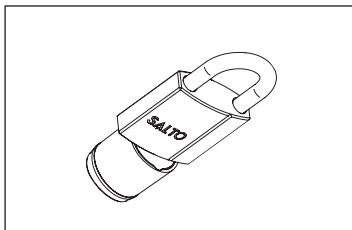

* This option has an additional price, please refer to the cylinder options chapter.
¹ Wireless version not available.
² LEGIC Cylinder can be slightly different

SALTO GEO electronic padlock
 (Can be programmed Selfprogrammable, ROM or RW system)

Prices - Gross prices	€
LEGIC advant: Standard Padlock 48 mm body - standard length.	461,75
LEGIC advant: Standard Padlock 58 mm body - standard length.	493,15
Mifare DESFire: Standard Padlock 48 mm body - standard length.	461,75
Mifare DESFire: Standard Padlock 58 mm body - standard length.	493,15
Mifare DESFire: Standard Padlock 48 mm body Wireless - standard length.	597,40
Mifare DESFire: Standard Padlock 58 mm body Wireless - standard length.	628,80
HID iCLASS: Standard Padlock 48 mm body - standard length.	610,20
HID iCLASS: Standard Padlock 58 mm body - standard length.	641,60
HID iCLASS: Standard Padlock 48 mm body Wireless - standard length.	745,85
HID iCLASS: Standard Padlock 58 mm body Wireless - standard length.	777,25

Technology	Model	Knob type	Body width	Schackle diameter	Schackle length	Finish	Cams	Wireless
G8 ^{1,2} LEGIC advant	P2	1 Removable Knob	48	8	30	CPB	N No applicable	-
			48 mm padlock body	8 mm only with 48mm padlock body	30 mm			
G9 Mifare DESFire			60	60 mm	W Wireless online			
GH HID iCLASS	58	9	90	90 mm		CPW		



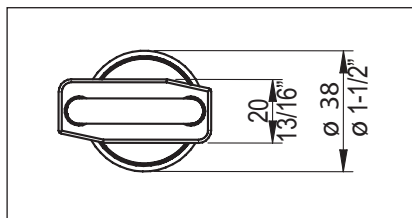
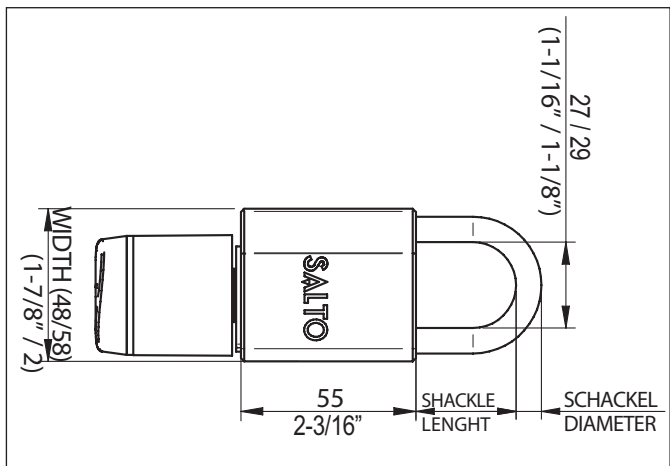

Measures







⚠ The SALTO GEO padlock is designed for indoor use only, in non-harsh environments and should not be used in applications where damage to the reader through dropping may be caused i.e. on chains attached to gates etc.

Product description	Product reference	€
---------------------	-------------------	---



Stainless steel finishes

Satin Chromiun Black reader 	G X X X X X X CSB X X	0,00
Satin Chromiun White reader 	G X X X X X X CSW X X	
Polished Chromiun Black reader 	G X X X X X X CPB X X	0,00
Polished Chromiun White reader 	G X X X X X X CPW X X	

Brass finishes

PVD Bright brass type Black reader 	G X X X X X X PPB X X	5,50
PVD Bright brass type White reader 	G X X X X X X PPW X X	
PVD Satin brass type Black reader 	G X X X X X X PMB X X	5,50
PVD Satin brass type White reader 	G X X X X X X PMW X X	

BioCoted Satin Chromiun Just the Reader and the knob are BioCoted, not the body either the Cam 	G X X X X X X BCB X X	40,80
---	------------------------------	-------

Black Satin Chromiun Black reader 	G X X X X X X NEB X X	8,65
Black Satin Chromiun White reader 	G X X X X X X NEW X X	

Example of price calculation for finishes other than Satin Stainless (IM), which is the standard used in our price list.

Required is G9E2030S30PPBD .	€
G9E2030S30CSBD	404,40
Additional price for PVD Bright brass type finish	5,50
Total Price:	409,90

 Please note that brass finishes may become discoloured over time due to their exposure to environmental conditions such as humidity, pollution and salt air. Rings and keys can also scratch the brass lacquer finish and once this has started to occur, discolouration will likely begin.

Model SP301585 SALTO 2,5mm Allen key for SALTO GEO battery replacement.

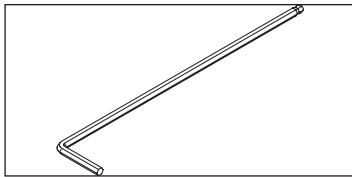

Prices - Gross prices		€
Description	Reference	
2,5mm Allen key for SALTO GEO battery replacement	S P 3 0 1 5 8 5	2,40

Model SP301582 SALTO CR2 battery for SALTO GEO cylinders.

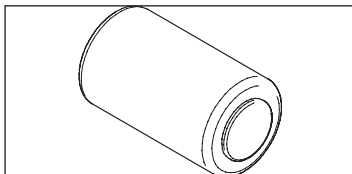

Prices - Gross prices		€
Description	Reference	
SALTO CR2 battery for SALTO GEO cylinders. Pack of 10 batteries	S P 3 0 1 5 8 2 - 1 0	69,50

Model SP220764 SALTO removable knob cylinder tool.

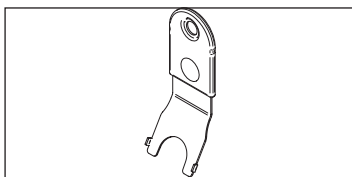

Prices - Gross prices		€
Description	Reference	
SALTO GEO cylinder removable knob tool	S P 2 2 0 7 6 4	7,20

SALTO Geo Grip A SALTO Geo cylinder grip A.
BioCote antimicrobial technology on it - Adapted to suit disabled people.

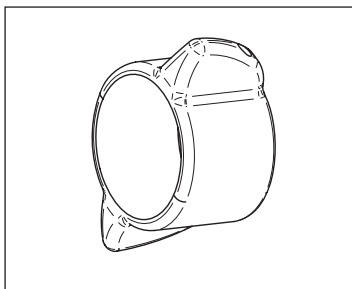

Prices - Gross prices		€
Description	Reference	
SALTO GEO Grip A - Black colour	SALTOGEOGRIPAN	5,65
SALTO GEO Grip A - Red colour	SALTOGEOGRIPAR	5,65
SALTO GEO Grip A - Green colour	SALTOGEOGRIPAG	5,65
SALTO GEO Grip A - Yellow colour	SALTOGEOGRIPAY	5,65
SALTO GEO Grip A - Blue colour	SALTOGEOGRIPAB	5,65
SALTO GEO Grip A - White colour	SALTOGEOGRIPAW	5,65

SALTO Geo Grip H SALTO Geo cylinder grip H.
BioCote antimicrobial technology on it.

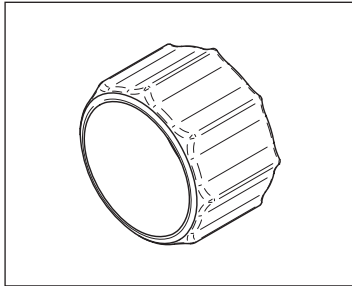

Prices - Gross prices		€
Description	Reference	
SALTO GEO Grip H - Black colour	SALTOGEOGRIPHN	5,65
SALTO GEO Grip H - Red colour	SALTOGEOGRIPHR	5,65
SALTO GEO Grip H - Green colour	SALTOGEOGRIPHG	5,65
SALTO GEO Grip H - Yellow colour	SALTOGEOGRIPHY	5,65
SALTO GEO Grip H - Blue colour	SALTOGEOGRIPHB	5,65
SALTO GEO Grip H - White colour	SALTOGEOGRIPHW	5,65

Model SP201587

SALTO euro cylinder measuring key (PZ).

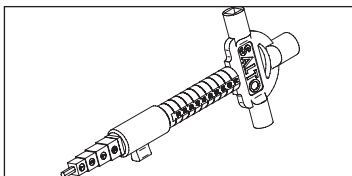

Prices - Gross prices		€
Description	Reference	
Euro cylinder measuring key (PZ)	S P 2 0 1 5 8 7	19,40



ÆElement Fusion is composed of three main components:

- The ÆElement Fusion electronics (Reader, battery holder and special spindles for ÆElement)
- The ÆElement Fusion mortise lock
- The Handles
- Thumbturn (for Euro mortise lock)
- Thumbturn rose (for Euro mortise lock)

To order ÆElement Fusion, you need to order all three components, two are necessary (ÆElement Fusion electronics and ÆElement Fusion mortise lock) but the handles can be provided by a third party supplier if required.

Third party suppliers' handles **MUST** be approved by SALTO.

Please refer to the Customer ANSI lever set for the relevant ÆElement document.

SALTO ÆElement Fusion electronics reference example:

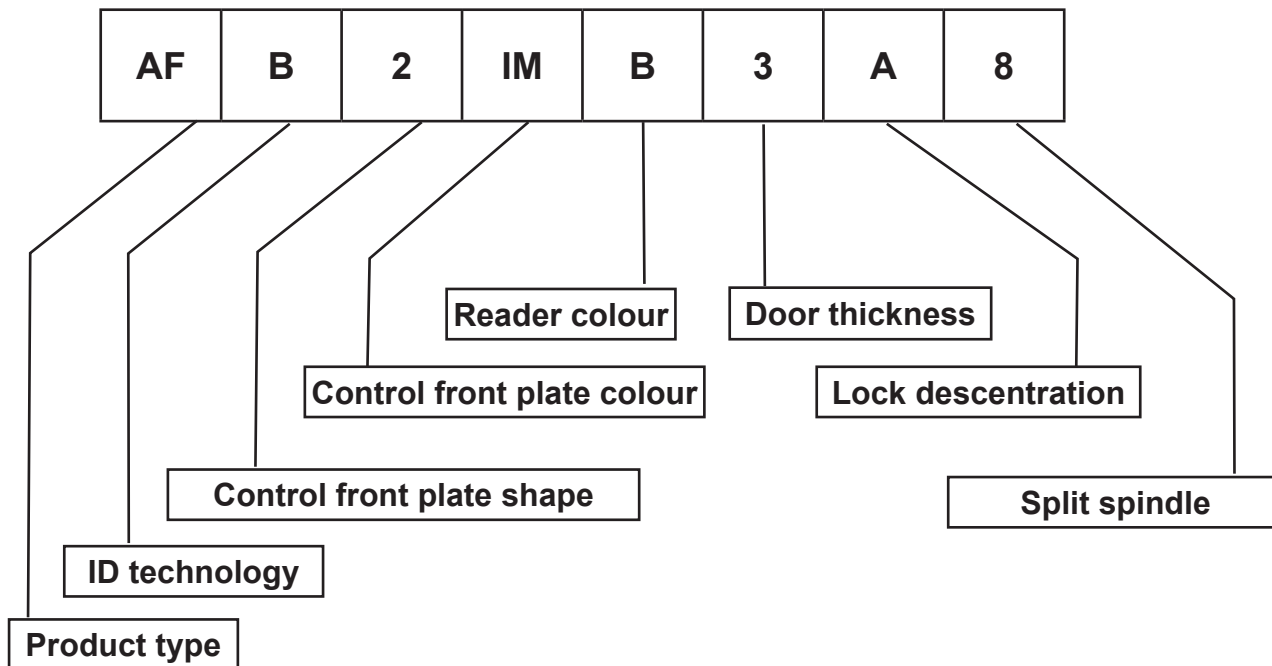

Product type

AF=ÆElement Fusion electronics

ID technology

B = Contactless BLE MIFARE / DESFire
 J = Contactless BLE HID iCLASS

Control front plate shape

- 0 = EURO 20mm round front plate
- 1 = EURO 20mm squared front plate
- 4 = EURO 24mm round front plate
- 5 = EURO 24mm squared front plate
- 7 = ANSI 27mm (1- 1/16")
- 2 = ANSI 32mm (1- 1/4")

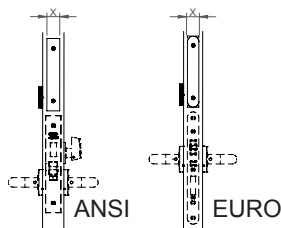

Control front plate colour

IM = Satin stainless steel (BHMA630 - US32D)
 PM =PVD satin brass type (BHMA730 - BHMA731 -US4)

Reader colour

B = Black
 W = White

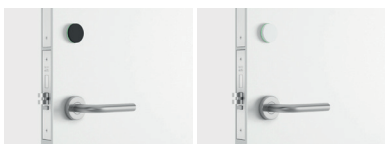

Door thickness

- | | | |
|---------------------------------|---------------------------------|-----------------------------------|
| 3 = $40 \leq t < 45\text{mm}$. | 6 = $65 \leq t < 70\text{mm}$. | 9 = $95 \leq t < 105\text{mm}$. |
| 4 = $45 \leq t < 55\text{mm}$. | 7 = $75 \leq t < 85\text{mm}$. | 0 = $105 \leq t < 115\text{mm}$. |
| 5 = $55 \leq t < 65\text{mm}$. | 8 = $85 \leq t < 95\text{mm}$. | 1 = $115 \leq t < 125\text{mm}$. |

Lock descentration

- | | |
|-------------------------------|-------------------------------|
| A = $17 \leq b < 30\text{mm}$ | D = $50 \leq b < 55\text{mm}$ |
| B = $30 \leq b < 35\text{mm}$ | 0 = without spindles |
| C = $40 \leq b < 50\text{mm}$ | |

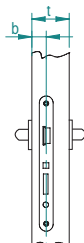

b is the minimum distance to one of the edges

** For rebated doors, min distance from door edge to control center line 17mm (11/16").

Door thickness and lock descentration for European lock

Min. door thickness 40mm

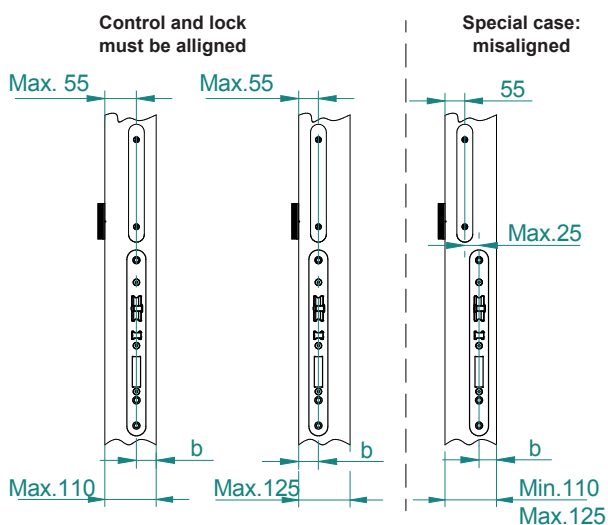

Door thickness and lock descentration for ANSI lock

Min. door thickness 44,5mm (1-3/4")

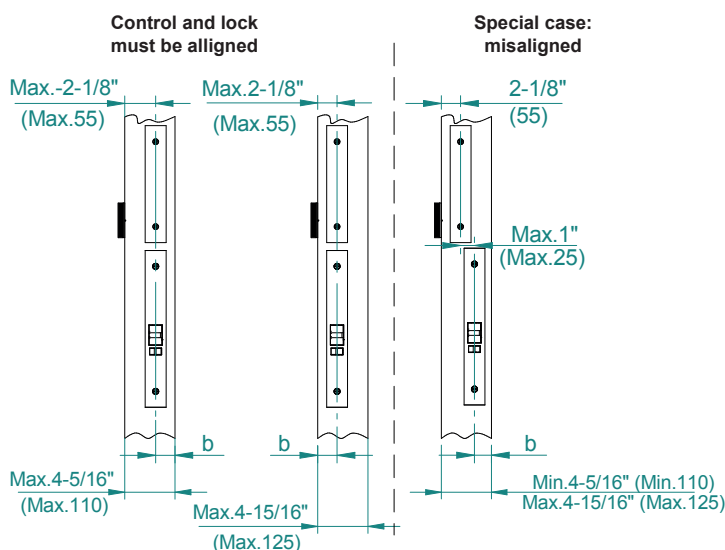

NOT ALL THE DOOR THICKNESS AND LOCK DESCENTRATION ARE POSSIBLE PLEASE CONSULT THIS CHART

	DOOR THICKNESS	0 Without spindles	A** $17 \leq b < 30\text{ mm}$ $3/4'' \leq b < 1\ 3/16''$	B $30 \leq b < 40\text{ mm}$ $1\ 3/16'' \leq b < 1\ 5/8''$	C $40 \leq b < 50\text{ mm}$ $1\ 5/8'' \leq b < 2''$	D $50 \leq b < 60\text{ mm}$ $2'' \leq b < 2\ 1/8''$
$40 \leq t < 45\text{ mm}$ $1\ 9/16'' \leq t < 1\ 3/4''$	3	✓	✓			
$45 \leq t < 55\text{ mm}$ $1\ 3/4'' \leq t < 2\ 1/8''$	4	✓	✓			
$55 \leq t < 65\text{ mm}$ $2\ 1/8'' \leq t < 2\ 9/16''$	5	✓	✓	✓		
$65 \leq t < 75\text{ mm}$ $2\ 9/16'' \leq t < 3''$	6	✓	✓	✓		
$75 \leq t < 85\text{ mm}$ $3'' \leq t < 3\ 3/8''$	7	✓	✓	✓	✓	
$85 \leq t < 95\text{ mm}$ $3\ 3/8'' \leq t < 3\ 3/4''$	8	✓	✓	✓	✓	
$95 \leq t < 105\text{ mm}$ $3\ 3/4'' \leq t < 4\ 1/8''$	9	✓	✓	✓	✓	✓
$105 \leq t < 115\text{ mm}$ $4\ 1/8'' \leq t < 4\ 1/2''$	0	✓	✓	✓	✓	✓
$115 \leq t < 125\text{ mm}$ $4\ 1/2'' \leq t < 4\ 15/16''$	1	✓	✓	✓	✓	✓

Split spindle

- 8 = 8mm
- 9 = 9mm

Model AFx

SALTO ÆElement Fusion electronics.

Includes split spindles that must be used with the ÆElement handle set
(Mortise lock and handles not included and must be ordered separately)

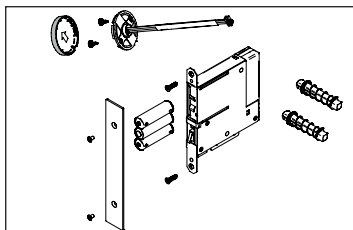

Prices - Gross prices

€



**MIFARE
DESFire**

BLE MIFARE DESFire - Standalone ÆElement Fusion electronics - Satin stainless steel front plate

349,40

BLE MIFARE DESFire - Standalone ÆElement Fusion electronics - Satin brass front plate

371,00



**iCLASS
HID**

BLE HID iCLASS - Standalone ÆElement Fusion electronics - Satin stainless steel front plate

349,40

BLE HID iCLASS - Standalone ÆElement Fusion electronics - Satin brass front plate

371,00

Product type	Technology	Control front plate shape	Control front plate finish	Reader colour	Door thickness	Lock descentration	Split spindle	
AF	B Prox. BLE Mifare DESFire	0 EURO 20mm round front plate	IM Satin stainless steel	B Black	3 40 ≤ t < 45 mm.	A 17 ≤ b < 30mm	8 8 mm	
		1 EURO 20mm squared front plate			4 45 ≤ t < 55 mm.			
		4 EURO 24mm round front plate			5 55 ≤ t < 65 mm.	B 30 ≤ b < 35mm		
		J Prox. BLE HID iCLASS			5 EURO 20mm squared front plate	6 65 ≤ t < 70 mm.		C 40 ≤ b < 50mm
					7 ANSI 27mm (1-1/16")	7 75 ≤ t < 85 mm.		
					2 ANSI 32mm (1-1/4")	8 85 ≤ t < 95 mm.		D 50 ≤ b < 55mm
	9 95 ≤ t < 105 mm.		0 Without spindles					
	0 105 ≤ t < 115 mm.							
	1 115 ≤ t < 125 mm.							



SALTO mortise lock reference example

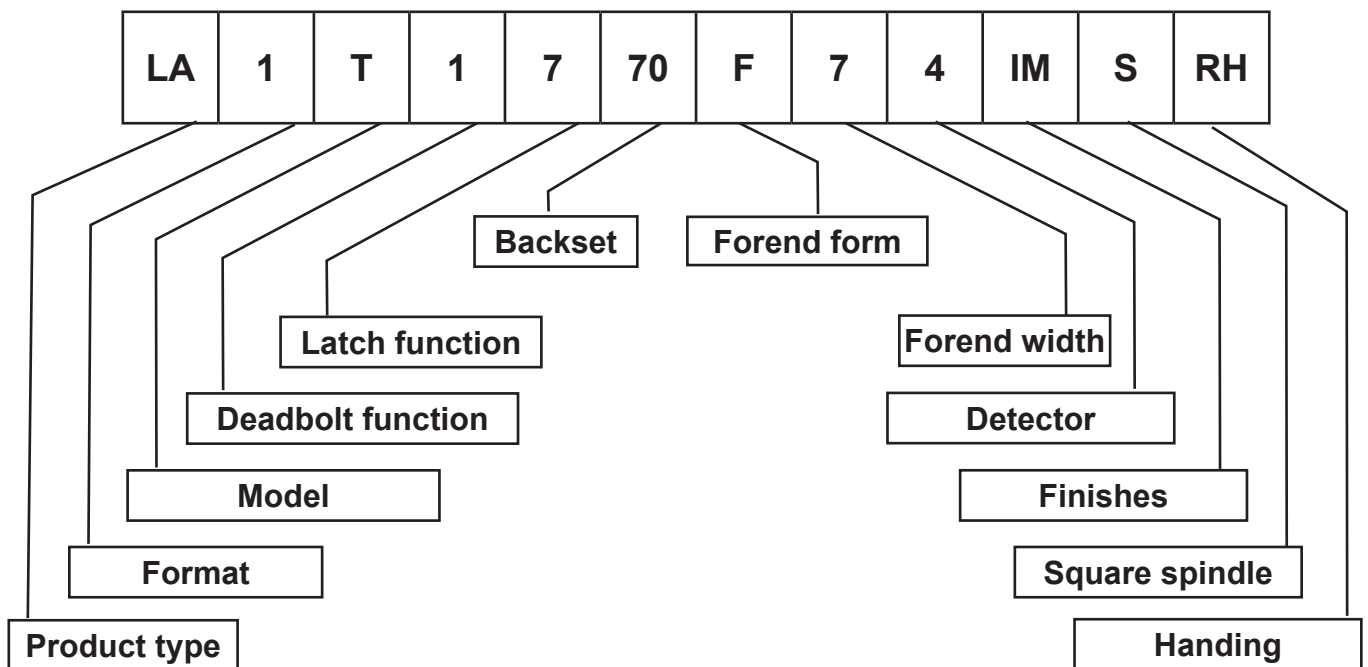

Product type:

LA = ANSI lock
LE = European lock

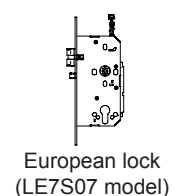
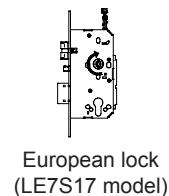

Format

7 = 72mm (European mortise lock).
1 = Gr 1 (ANSI mortise lock)

Models

T
S

Dead bolt function:

0 = Without deadbolt
1 = Dead bolt + panic function

Latch function:

7 = Spindle block mechanism

Backset:

55 = 55mm
65 = 65mm
70 = 70mm

Forend form:

R = Round
C = Squared
F = ANSI for ÆElement Fusion

Foreend width:

- 0 = 20mm (EURO)
- 4 = 24mm (EURO)
- T = 20mm Asymmetric front plate (EURO)
- W = 24mm Asymmetric front plate (EURO)
- 2 = 32mm (ANSI)
- 7 = 27mm (ANSI)

Detector:

- 1 = deadbolt detector (privacy)
- 2 = handle and door detector
- 3 = privacy, door and handle detector
- 4 = handle, privacy, door and override detector

Finishes:

- IM = Stainless steel
- EL = Gold enameled (Euro)
- PM = PVD Satin brass (ANSI)

Square spindle:

- S = 8mm split
- V = 9mm split

Handing:

- = Reversible for European locks with symmetrical front plate
- LH = Left handing
- RH = Right handing
- LR = Left handing
- RR = Right handing

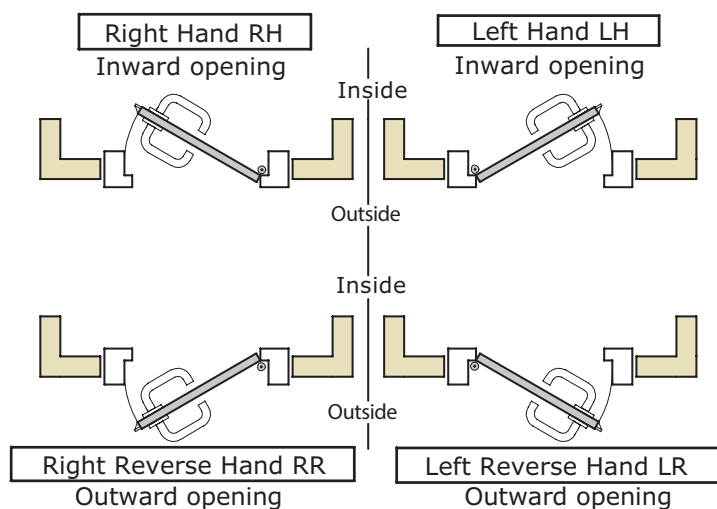

<h3 style="margin: 0;">Model LE7S07</h3>	<p>SALTO ÆElement Euro mortise lock (DIN 18251). To be used with SALTO ÆElement handleset and electronics. Just with latch, Door and handle detector built in. Strike plate and dust box included.</p>
--	---

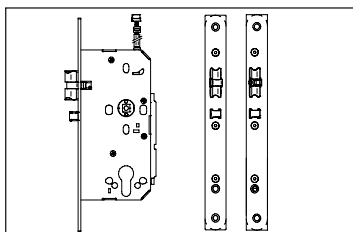

Prices - Gross prices	€
LE7S07 mortise lock for ÆElement - Door and handle detector - any spindle - IM finish	146,10
LE7S07 mortise lock for ÆElement - Door and handle detector - any spindle - EL finish	154,55

Mortise lock	Backset	Front plate shape	Front plate	Detector	Finish	Spindle	Handing
LE7S07	55 55mm	R round	0 ¹ 20mm Symmetric	2 Door and handle detector	IM Satin stainless steel	S 8mm split	-1 Symmetric front plate no handing
	65 65mm		4 ¹ 24mm Symmetric				R Right hand for Asymmetric front plate
	60 ² 60mm	C squared	T ³ 20mm Asymmetric				L Left hand for Asymmetric front plate
	70 ² 70mm		W ^{2,3} 24mm Asymmetric				

- 1 Mortise locks with symmetrical front plates do not need handing. Handing needed just for asymmetrical front plates**
- 2 Options not standard. Delivery subject to availability.**
- 3 Asymmetrical front plates T & W (for rebated doors) are handed and the handing needs to be detailed when ordering. Those locks don't include strike plate and dust box.**

<h3 style="margin: 0;">Model LE7S17</h3>	<p>SALTO ÆElement Euro mortise lock (DIN 18251). To be used with SALTO ÆElement handleset and electronics. With latch and deadbolt. Strike plate and dust box included.</p>
--	--

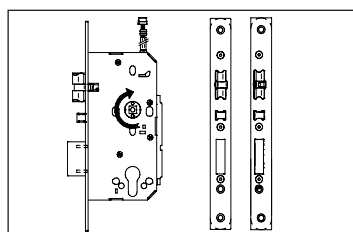

Prices - Gross prices	€
LE7S17 mortise lock for ÆElement - Privacy detector - any spindle - IM finish	140,55
LE7S17 mortise lock for ÆElement - Privacy detector - any spindle - EL finish	148,15
LE7S17 mortise lock for ÆElement - Door, privacy and handle detector - any spindle - IM finish	156,15
LE7S17 mortise lock for ÆElement - Door, privacy and handle detector - any spindle - EL finish	164,60

Mortise lock	Backset	Front plate shape	Front plate	Detector	Finish	Spindle	Handing		
LE7S17	55 55mm	R round	0 ¹ 20mm Symmetric	1 Privacy detector	IM Satin stainless steel	S 8mm split	-1 Symmetric front plate no handing		
	65 65mm		4 ¹ 24mm Symmetric				R Right hand for Asymmetric front plate		
	60 ² 60mm	C squared	T ³ 20mm Asymmetric	3 Privacy, door and handle detector			EL Satin brass	V 9mm split	L Left hand for Asymmetric front plate
	70 ² 70mm		W ^{2,3} 24mm Asymmetric						

- 1 Mortise locks with symmetrical front plates do not need handing. Handing needed just for asymmetrical front plates**
- 2 Options not standard. Delivery subject to availability.**
- 3 Asymmetrical front plates T & W (for rebated doors) are handed and the handing needs to be detailed when ordering. Those locks don't include strike plate and dust box.**

Model LA1T17

SALTO ÆElement ANSI mortise lock with deadbolt for ÆElement Fusion.

To be used with SALTO ÆElement handleset.

To be combined with mechanical privacy ÆElement Fusion electronics. Strike plate and dust box included.

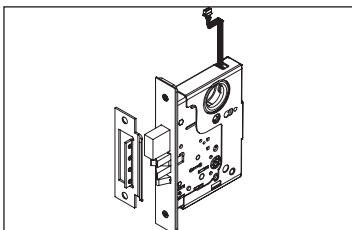

Prices - Gross prices	€
LA1T17 mortise lock for ÆElement Fusion - IM finish	189,90
LA1T17 mortise lock for ÆElement Fusion - PM finish	198,30

Mortise lock	Backset	Front plate shape	Front plate	Detector	Finish	Spindle	Handing	
LA1T17	70 70mm (2 - 3/4")	F ANSI squared for ÆElement Fusion	2 32mm	4 Privacy, handle, door and override detector	IM Satin stainless steel	S 8mm (5/16") Split	RH right hand	
			7 27mm				PM Satin brass	LH left hand
							RR right hand reverse	
			LR left hand reverse					



The mortise locks are reversible. You can order the correct handing to save time on site
On stock LA1T1770AF24IMSRH / LH. For other combinations the delivery date can be different to 4 weeks.

Model LA1T07

SALTO ÆElement ANSI mortise lock without deadbolt for ÆElement Fusion.

To be used with SALTO ÆElement handleset. To be combined with mechanical privacy or mechanical ÆElement fusion electronics. Strike plate and dust box included.

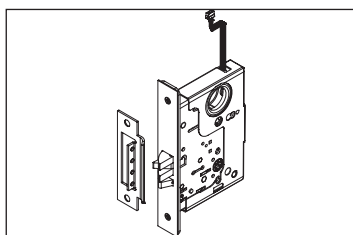

Prices - Gross prices	€
LA1T07 mortise lock for ÆElement Fusion - IM finish	168,95
LA1T07 mortise lock for ÆElement Fusion - PM finish	177,30

Mortise lock	Backset	Front plate shape	Front plate	Detector	Finish	Spindle	Handing	
LA1T07 for electronic without electronic privacy	70 70mm (2 - 3/4")	F ANSI squared for ÆElement Fusion	2 32mm	4 Privacy, handle, door and override detector	IM Satin stainless steel	S 8mm (5/16") Split	RH right hand	
			7 27mm				PM Satin brass	LH left hand
							RR right hand reverse	
			LR left hand reverse					



The mortise locks are reversible. You can order the correct handing to save time on site
On stock LA1T0770F24IMSRH / LH. For other combinations the delivery date can be different to 4 weeks.

Model TE010

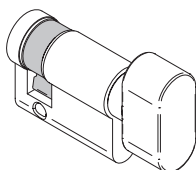

SALTO Privacy thumbturn for ÆElement Fusion European.
PZ profile. To be used in combination with the SALTO European mortise lock LE7Sx7.

Prices - Gross prices	€
TE010H - Satin Nickel finish	
TE010H30NM - Thumbturn 30,5mm internal length.	20,75
TE010H35NM - Thumbturn 35,5mm internal length.	22,25
TE010H40NM - Thumbturn 40,5mm internal length.	22,60
TE010H45NM - Thumbturn 45,5mm internal length.	23,90
TE010H50NM - Thumbturn 50,5mm internal length.	24,90
TE010H - Polished Nickel finish	
TE010H30IP - Thumbturn 30,5mm internal length.	20,15
TE010H35IP - Thumbturn 35,5mm internal length.	21,15
TE010H40IP - Thumbturn 40,5mm internal length.	21,95
TE010H45IP - Thumbturn 45,5mm internal length.	23,25
TE010H50IP - Thumbturn 50,5mm internal length.	24,15
TE010H - Satin Brass colour finish	
TE010H30PM - Thumbturn 30,5mm internal length.	28,85
TE010H35PM - Thumbturn 35,5mm internal length.	29,90
TE010H40PM - Thumbturn 40,5mm internal length.	30,40
TE010H45PM - Thumbturn 45,5mm internal length.	32,10
TE010H50PM - Thumbturn 50,5mm internal length.	33,05
TE010H - Polished Brass colour finish	
TE010H30PP - Thumbturn 30,5mm internal length.	28,85
TE010H35PP - Thumbturn 35,5mm internal length.	29,90
TE010H40PP - Thumbturn 40,5mm internal length.	30,40
TE010H45PP - Thumbturn 45,5mm internal length.	32,10
TE010H50PP - Thumbturn 50,5mm internal length.	33,05
TE010H - Black chromium colour finish	
TE010H30NE - Thumbturn 30,5mm internal length.	30,50
TE010H35NE - Thumbturn 35,5mm internal length.	31,75
TE010H40NE - Thumbturn 40,5mm internal length.	33,15
TE010H45NE - Thumbturn 45,5mm internal length.	34,45
TE010H50NE - Thumbturn 50,5mm internal length.	35,80
TE010H - BioCote finish	
TE010H30BC - Thumbturn 30,5mm internal length.	30,50
TE010H35BC - Thumbturn 35,5mm internal length.	31,75
TE010H40BC - Thumbturn 40,5mm internal length.	33,15
TE010H45BC - Thumbturn 45,5mm internal length.	34,45
TE010H50BC - Thumbturn 50,5mm internal length.	35,80

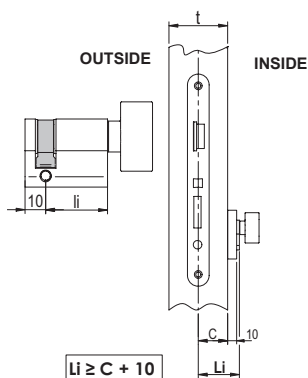

Product	Model	Outside length	Thumbturn	Internal length	Finish
T	E0	10	H	30 (30,5mm)	NM Satin nickel
				35 (35,5mm)	IP Polished nickel plated
				40 (40,5mm)	PM Satin brass colour
				45 (45,5mm)	PP Polished brass colour
				50 (50,5mm)	NE Black chromium
					BC BioCote

Model HT

SALTO Rose Accessory model HT
Round rose, with PZ cut out on the inside to be used with TE010 privacy thumbturn.

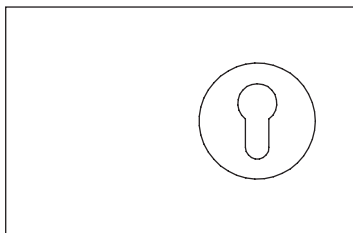

Available for European mortise locks.

Prices - Gross prices		€
Description	Reference	
SALTO Rose model HT - satin stainless steel type finish	R S H T R I M	11,50
SALTO Rose model HT-Bright stainless steel type finish	R S H T R I P	12,55
SALTO Rose model HT - PVD bright brass type finish	R S H T R P P	20,75
SALTO Rose model HT - PVD satin brass type finish	R S H T R P M	19,90
SALTO Rose model HT - Antique brass type finish	R S H T R I A	18,45
SALTO Rose model HT - Black chromium type finish	R S H T R N E	18,45
SALTO Rose model HT - BioCote type finish	R S H T R B C	20,75



IM
Satin stainless steel
type

Rose	Manufacturer	Model	Format	Finish
R	S SALTO	HT	R Round	IM
				IP
				PP
				PM
				IA
				NE
				BC

Model PH

SALTO Rose Accessory model PH
Round rose, with PZ cut out on the outside.

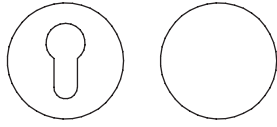

Available for European mortise locks.

Prices - Gross prices		€
Description	Reference	
SALTO Rose model PH - satin stainless steel type finish	R S P H R I M 3	11,50
SALTO Rose model PH-Bright stainless steel type finish	R S P H R I P 3	12,55
SALTO Rose model PH - PVD bright brass type finish	R S P H R P P 3	20,75
SALTO Rose model PH- PVD satin brass type finish	R S P H R P M 3	19,90
SALTO Rose model PH - Antique brass type finish	R S P H R I A 3	18,45
SALTO Rose model PH - Black chromium type finish	R S P H R N E 3	18,45
SALTO Rose model PH - BioCote type finish	R S P H R B C 3	20,75



IM
Satin stainless steel
type

Rose	Manufacturer	Model	Format	Finish	Door thickness
R	S SALTO	PH	R	IM	3 37 < t < 50mm
				IP	
				PP	
				PM	5 50 < t < 70mm
				IA	
				NE	
				BC	

Model PZ

SALTO Rose Accessory model PZ
Round rose, with PZ cut out on the outside and on the inside.

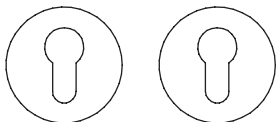

Available for European mortise locks.

Prices - Gross prices		€
Description	Reference	
SALTO Rose model PZ - satin stainless steel type finish	R S P Z R I M 3	11,50
SALTO Rose model PZ-Bright stainless steel type finish	R S P Z R I P 3	12,55
SALTO Rose model PZ - PVD bright brass type finish	R S P Z R P P 3	20,75
SALTO Rose model PZ- PVD satin brass type finish	R S P Z R P M 3	19,90
SALTO Rose model PZ - Antique brass type finish	R S P Z R I A 3	18,45
SALTO Rose model PZ - Black chromium type finish	R S P Z R N E 3	18,45
SALTO Rose model PZ - BioCote type finish	R S P Z R B C 3	20,75



IM
Satin stainless steel
type

Rose	Manufacturer	Model	Format	Finish	Door thickness
R	S SALTO	PZ	R	IM	3 37 < t < 50mm
				IP	
				PP	
				PM	5 50 < t < 70mm
				IA	
				NE	
				BC	

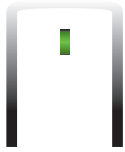

by SALTO



ÆElement is composed of three main components:

- The ÆElement electronics (Reader, battery holder and special spindles for ÆElement)
- The ÆElement mortise lock
- The Handles

To order ÆElement, you need to order all three components, two are necessary (ÆElement electronics and ÆElement mortise lock) but the handles can be provided by a third party supplier if required.

The model of handle however **MUST** be approved by SALTO.

Please refer to the Customer EURO or ANSI lever set for the relevant ÆElement document.

SALTO ÆElement electronics reference example:

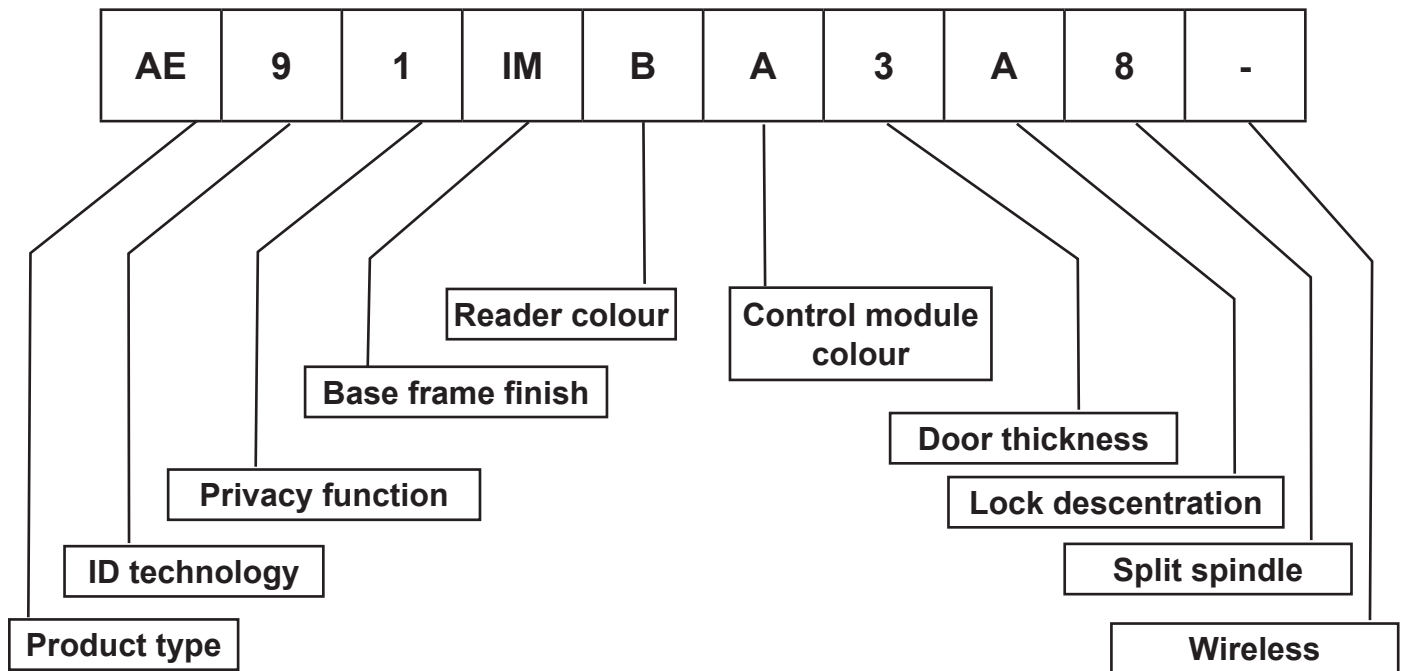

Product type

AE=ÆElement electronic lock

ID technology

9 = Contactless MIFARE / DESFire
B = Contactless BLE MIFARE / DESFire
J = Contactless BLE HID iCLASS

Privacy function

0 = Without electronic privacy function
1 = With electronic privacy function

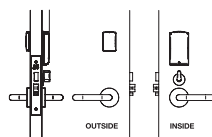

AE90
Without electronic privacy
In combination with
LE7E37 (for access control)
LA1M17(for hospitality)
LA1M07(for access control)

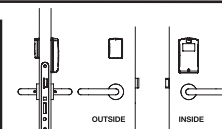

AE91
With electronic privacy
In combination with
LE7E37 (for hospitality)
LA1T07(for hospitality)

Base frame finish

IM = Satin stainless steel (BHMA630 - US32D)
IP = Bright stainless steel (BHMA629 - US32)

PM =PVD satin brass type (US4)
PP = PVD bright brass type (US3)
IA = Old brass (BHMA638 - USS)
NE = Black chromium

Reader colour

B = Black
W = White



Battery pack colour

W = White
A = Anthracite (RAL 7016)
C = Gold (like the ESD)
I = Iron blue (like the ESD)

Door thickness

3 = 35 ≤ t < 45mm. 8 = 85 ≤ t < 95mm.
4 = 45 ≤ t < 55mm. 9 = 95 ≤ t < 105mm.
5 = 55 ≤ t < 65mm. 0 = 105 ≤ t < 115mm.
6 = 65 ≤ t < 75mm. 1 = 115 ≤ t < 125mm.
7 = 75 ≤ t < 85mm.

Lock descentration

N = 15 ≤ b < 20mm
A** = 20 ≤ b < 30mm
B = 30 ≤ b < 40mm
C = 40 ≤ b < 50mm
D = 50 ≤ b < 60mm
E = 60 ≤ b < 70mm
0 = without spindles

edge to lock center

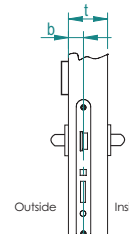

!
** for door thickness
3, descentration
A goes from 15 to
30mm

Split spindle

8 = 8mm
9 = 9mm (just for European mortise locks)

Wireless

- = (dash) wireless RFnet ready or
wireless BLUENet ready (just for BLE model)
W = Wireless RFnet online (just for mifare version)

Door thickness

- 3 = 35 ≤ t < 45mm.
- 4 = 45 ≤ t < 55mm.
- 5 = 55 ≤ t < 65mm.
- 6 = 65 ≤ t < 75mm.
- 7 = 75 ≤ t < 85mm.

- 8 = 85 ≤ t < 95mm.
- 9 = 95 ≤ t < 105mm.
- 0 = 105 ≤ t < 115mm.
- 1 = 115 ≤ t < 125mm.

Lock descentration

- N = 15 ≤ b < 20mm
- A** = 20 ≤ b < 30mm
- B = 30 ≤ b < 40mm
- C = 40 ≤ b < 50mm
- D = 50 ≤ b < 60mm
- E = 60 ≤ b < 70mm
- 0 = without spindles

* Min distance from door edge to lock center

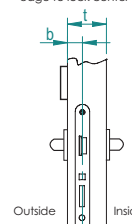

** for door thickness 3, descentration A goes from 15 to 30mm



NOT ALL THE DOOR THICKNESS AND LOCK DESCENTRATION ARE POSSIBLE PLEASE CONSULT THIS CHART

	DOOR THICKNESS	A** 20 ≤ b < 30 mm 3/8" ≤ b < 1 3/16"	0 Without spindles	N 15 ≤ b < 20 mm 5/8" ≤ b < 3/4"	B 30 ≤ b < 40 mm 1 3/16" ≤ b < 1 5/8"	C 40 ≤ b < 50 mm 1 5/8" ≤ b < 2"	D 50 ≤ b < 60 mm 2" ≤ b < 2 1/8"	E 60 ≤ b < 70 mm 2 1/8" ≤ b < 2 3/4"
35 ≤ t < 45 mm 1 3/8" ≤ t < 1 3/4"	3	V	V					
45 ≤ t < 55 mm 1 3/4" ≤ t < 2 1/8"	4	V	V	V				
55 ≤ t < 65 mm 2 1/8" ≤ t < 2 9/16"	5	V	V	V	V			
65 ≤ t < 75 mm 2 9/16" ≤ t < 3"	6	V	V	V	V			
75 ≤ t < 85 mm 3" ≤ t < 3 3/8"	7	V	V	V	V	V		
85 ≤ t < 95mm 3 3/8" ≤ t < 3 3/4"	8	V	V	V	V	V		
95 ≤ t < 105 mm 3 3/4" ≤ t < 4 1/8"	9	V	V	V	V	V	V	V
105 ≤ t < 115 mm 4 1/8" ≤ t < 4 1/2"	0	V	V	V	V	V	V	V
115 ≤ t < 125 mm 4 1/2" ≤ t < 4 15/16"	1	V	V	V	V	V	V	V

Split spindle

- 8 = 8mm
- 9 = 9mm (just for European mortise locks)

Wireless

- = (dash) wireless ready
- W = Wireless online

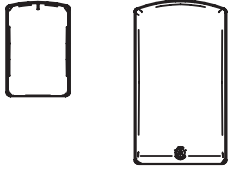
Model AE90	<p>SALTO ÆElement electronics without electronic privacy. Includes split spindles that must be used with the ÆElement handle set (Mortise lock and handles not included and must be ordered separately)</p>		
 OUTSIDE INSIDE	Prices - Gross prices		€
	MIFARE DESFire Wireless ready - Standalone ÆElement electronics.		274,85
	MIFARE DESFire Wireless online - Wireless online ÆElement electronics.		380,75
	BLE MIFARE DESFire - Standalone ÆElement electronics. Wireless BLUEnet ready - Wireless RFnet not possible with this technology		302,55
	BLE HID iCLASS- Standalone ÆElement electronics.		302,55

AE	Technology	Function	Finish base	Reader colour	Battery holder colour	Door thickness	Lock descentration	Split spindle	Wireless
AE	9 MIFARE DESFire	0 Without electronic privacy	IM Satin stainless steel	B Black	W White	3 35 ≤ t < 45mm.	N 15sb<20mm	8 8 mm	-
			IP Bright stainless steel			4 45 ≤ t < 55mm.			
			IA ¹ Antique brass			5 55 ≤ t < 65mm.	B 30sb<40mm		
	PM ¹ Satin brass			6 65 ≤ t < 75mm.	C 40sb<50mm				
				W White	7 75 ≤ t < 85mm.	D 50sb<60mm			
	PP ¹ Bright brass		8 85 ≤ t < 95mm.		E 60sb<70mm				
		J BLE HID iCLASS	1 With electronic privacy		NE ¹ Black chromium	W White	C Gold (Like the ESD)	9 95 ≤ t < 105mm.	0 Without spindles
	I Iron blue (Like the ESD)			0 105 ≤ t < 115mm.					
									1 115 ≤ t < 125mm.

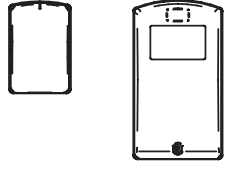
Model AE91	<p>SALTO ÆElement electronics with electronic privacy. Includes split spindles that must be used with the ÆElement handle set (Mortise lock and handles not included and must be ordered separately)</p>		
 OUTSIDE INSIDE	Prices - Gross prices		€
	MIFARE DESFire Wireless ready - Standalone ÆElement electronics.		284,95
	MIFARE DESFire Wireless online - Wireless online ÆElement electronics.		390,60
	BLE MIFARE DESFire - Standalone ÆElement electronics. Wireless BLUEnet ready - Wireless RFnet not possible with this technology		312,65
	BLE HID iCLASS- Standalone ÆElement electronics.		312,65







AE	Technology	Function	Finish base	Reader colour	Battery holder colour	Door thickness	Lock descentration	Split spindle	Wireless
AE	9 MIFARE DESFire	1 With electronic privacy	IM Satin stainless steel	B Black	W White	3 35 ≤ t < 45mm.	N 15sb<20mm	8 8 mm	-
			IP Bright stainless steel			4 45 ≤ t < 55mm.			
			IA ¹ Antique brass			5 55 ≤ t < 65mm.	B 30sb<40mm		
	PM ¹ Satin brass			6 65 ≤ t < 75mm.	C 40sb<50mm				
				W White	7 75 ≤ t < 85mm.	D 50sb<60mm			
	PP ¹ Bright brass		8 85 ≤ t < 95mm.		E 60sb<70mm				
		J BLE HID iCLASS	1 With electronic privacy		NE ¹ Black chromium	W White	C Gold (Like the ESD)	9 95 ≤ t < 105mm.	0 Without spindles
	I Iron blue (Like the ESD)			0 105 ≤ t < 115mm.					
									1 115 ≤ t < 125mm.



¹ The option for finishes has an additional price please refer to the chapter below.

The Electronics do not include the complete handleset. The mortise lock and the handles need to be ordered separately.

The split spindles are delivered with the electronics, and need to be used even if the handles are supplied from a third party manufacturer. SALTO will not be responsible in any way for handles that are fitted with split spindles other than those supplied with the ÆElement electronics.

Product description	Product reference	€
Stainless steel finishes		
Base frame in Satin stainless steel type finish 	AE9xIM x x x x x	0,00
Base frame in Polished stainless steel type finish. 	AE9xIP x x x x x	0,00
Brass finishes		
Base frame in PVD bright brass finish. 	AE9xPP x x x x x	21,55
Base frame in PVD satin brass finish. 	AE9xPM x x x x x	21,55
Base frame in Antique brass finish. 	AE9xIA x x x x x	7,15
Base frame in Black chromium finish. 	AE9xNE x x x x x	22,60

Example of price calculation for finishes other than Satin Stainless (IM), which is the standard used in our price list.

Required is AE91PMBG3.	€
AE91IMBG	284,95
Additional price for PM finish	21,55
Total Price:	306,50

Model Wireless antenna	SALTO Wireless antenna Kit. Kit to convert ÆElement wireless ready locks to wireless.
-------------------------------	--

Prices - Gross prices	€
Description	Reference
SALTO ÆElement wireless antenna	R F M O D U L E W 0 2
	107,85



SALTO escutcheon reference example

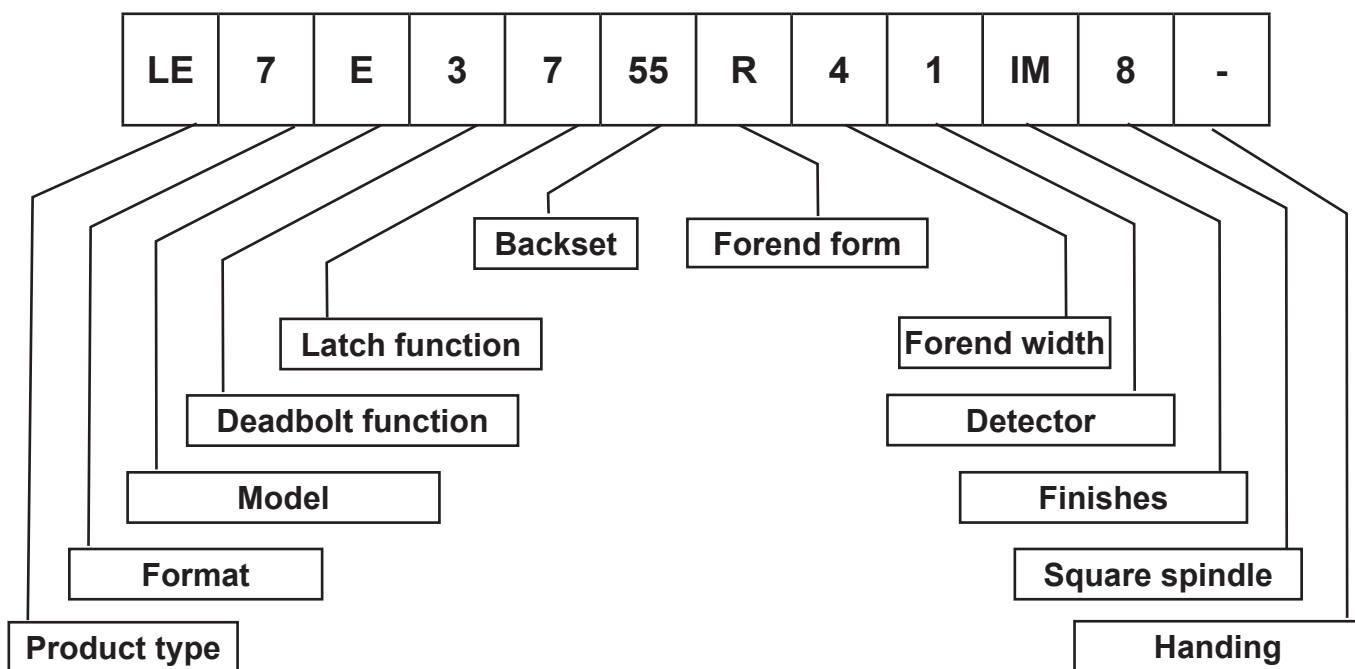

Product type:

LE = European lock
LA = ANSI lock

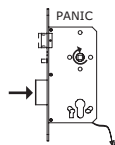

European locks
(LE7E37 model)

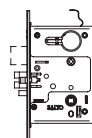

ANSI lock
(LA1T17) model)

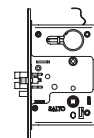

ANSI lock
(LA1T07) model)

Format

7 = 72mm (European mortise lock).
1 = Gr 1 (ANSI mortise lock)

Models

E
T
S

Dead bolt function:

0 = Without deadbolt
1 = Dead bolt + panic function
3 = Automatic deadbolt through

Latch function:

7 = Spindle block mechanism

Backset:

55 = 55mm
65 = 65mm
70 = 70mm

Foreend form:

R = Round
C = Squared
A = ANSI

Foreend width:

0 = 20mm (EURO)
4 = 24mm (EURO)
T = 20mm Asymmetric front plate (EURO)
W = 24mm Asymmetric front plate (EURO)
2 = 32mm (ANSI)
7 = 27mm (ANSI)

Detector:

1 = deadbolt detector (privacy)
2 = handle and door detector
3 = privacy, door and handle detector
4 = handle, privacy, door and override detector

Finishes:

IM = Stainless steel
EL = Gold enameled
PM = PVD Satin brass (ANSI)

Square spindle:

S = 8mm split
V = 9mm split

Handing:

LH = Left handing
RH = Right handing
LR = Left handing
RR = Right handing

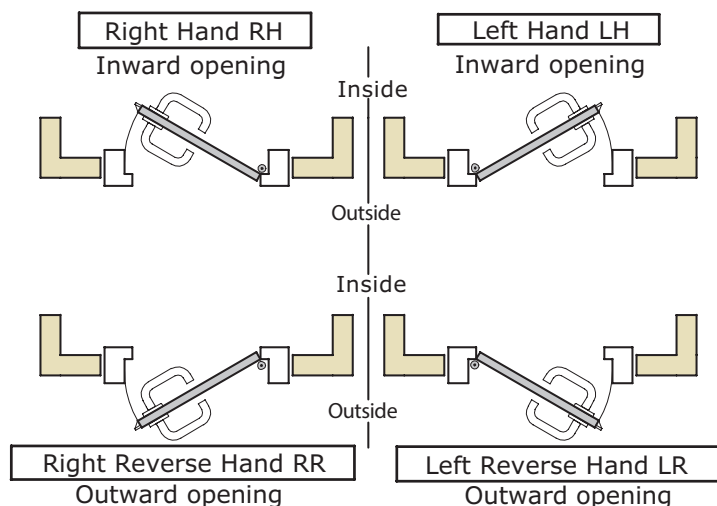

Model LE7S07	<p>SALTO ÆElement Euro mortise lock (DIN 18251). To be used with SALTO ÆElement handleset and electronics. Just with latch, Door and handle detector built in. Strike plate and dust box included.</p>
---------------------	--

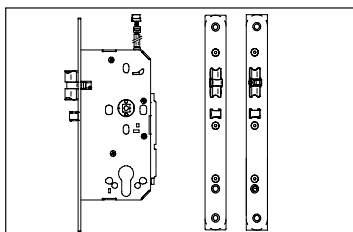

Prices - Gross prices	€
LE7S07 mortise lock for ÆElement - Door and handle detector - any spindle - IM finish	146,10
LE7S07 mortise lock for ÆElement - Door and handle detector - any spindle - EL finish	154,55

Mortise lock	Backset	Front plate shape	Front plate	Detector	Finish	Spindle	Handing
LE7S07	55 55mm	R round	0¹ 20mm Symmetric	2 Door and handle detector	IM Satin stainless steel	S 8mm split	.1 Symmetric front plate no handing
	65 65mm		4¹ 24mm Symmetric				R Right hand for Asymmetric front plate
	60² 60mm	C squared	T³ 20mm Asymmetric		EL Satin brass	V 9mm split	L Left hand for Asymmetric front plate
	70² 70mm		W^{2,3} 24mm Asymmetric				

- ¹ Mortise locks with symmetrical front plates do not need handing. Handing needed just for asymmetrical front plates**
- ² Options not standard. Delivery subject to availability.**
- ³ Asymmetrical front plates T & W (for rebated doors) are handed and the handing needs to be detailed when ordering. Those locks don't include strike plate and dust box.**

Model LE7S17	<p>SALTO ÆElement Euro mortise lock (DIN 18251). To be used with SALTO ÆElement handleset and electronics. With latch and deadbolt. Strike plate and dust box included.</p>
---------------------	---

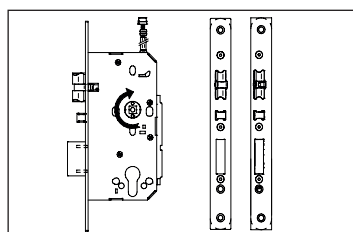

Prices - Gross prices	€
LE7S17 mortise lock for ÆElement - Privacy detector - any spindle - IM finish	140,55
LE7S17 mortise lock for ÆElement - Privacy detector - any spindle - EL finish	148,15
LE7S17 mortise lock for ÆElement - Door, privacy and handle detector - any spindle - IM finish	156,15
LE7S17 mortise lock for ÆElement - Door, privacy and handle detector - any spindle - EL finish	164,60

Mortise lock	Backset	Front plate shape	Front plate	Detector	Finish	Spindle	Handing
LE7S17	55 55mm	R round	0¹ 20mm Symmetric	1 Privacy detector	IM Satin stainless steel	S 8mm split	.1 Symmetric front plate no handing
	65 65mm		4¹ 24mm Symmetric				R Right hand for Asymmetric front plate
	60² 60mm	C squared	T³ 20mm Asymmetric	3 Privacy, door and handle detector	EL Satin brass	V 9mm split	L Left hand for Asymmetric front plate
	70² 70mm		W^{2,3} 24mm Asymmetric				

- ¹ Mortise locks with symmetrical front plates do not need handing. Handing needed just for asymmetrical front plates**
- ² Options not standard. Delivery subject to availability.**
- ³ Asymmetrical front plates T & W (for rebated doors) are handed and the handing needs to be detailed when ordering. Those locks don't include strike plate and dust box.**

Model LE7E37

SALTO ÆElement Euro mortise lock (DIN 18250).

To be used with SALTO ÆElement handleset.
With deadbolt detector. Strike plate and dust box included.

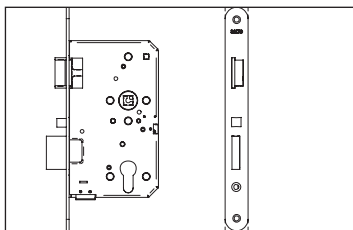

Prices - Gross prices	€
LE7E37 mortise lock for ÆElement - 8mm split spindle - IM finish	189,90
LE7E37 mortise lock for ÆElement - 8mm split spindle - EL finish	198,30
LE7E37 mortise lock for ÆElement - 9mm split spindle - IM finish	189,90
LE7E37 mortise lock for ÆElement - 9mm split spindle - EL finish	198,30

Mortise lock	Backset	Front plate shape	Front plate	Detector	Finish	Spindle	Handing
LE7E37	55 55mm	C squared	0 20mm	1 deadbolt detector	IM Satin stainless steel	S 8mm split	RH right hand
							LH left hand
	65 65mm	R round	4 24mm		EL Satin brass	V 9mm split	RR right hand reverse
							LR left hand reverse



The mortise locks are not reversible. Be sure to order the correct handing.
On stock LE7E3755R41MSRH / LH. For other combinations the delivery date can be different to 4 weeks.

Model LA1T17

SALTO ÆElement ANSI mortise lock with deadbolt.

To be used with SALTO ÆElement handleset.
To be combined with mechanical privacy ÆElement electronics. Strike plate and dust box included.

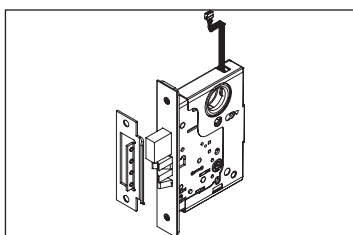

Prices - Gross prices	€
LA1T17 mortise lock for ÆElement - IM finish	189,90
LA1T17 mortise lock for ÆElement - PM finish	198,30

Mortise lock	Backset	Front plate shape	Front plate	Detector	Finish	Spindle	Handing
LA1T17 for electronic without electronic privacy	70 70mm (2 - 3/4")	A ANSI squared	2 32mm	4 Privacy, handle, door and override detector	IM Satin stainless steel	S 8mm (5/16") Split	RH right hand
			7 27mm				PM Satin brass
			RR right hand reverse				
			LR left hand reverse				



The mortise locks are reversible. You can order the correct handing to save time on site.
On stock LA1T1770A241MSRH / LH. For other combinations the delivery date can be different to 4 weeks.

Model LA1T07

SALTO ÆElement ANSI mortise lock without deadbolt.

To be used with SALTO ÆElement handleset. To be combined with mechanical privacy or mechanical ÆElement electronics. Strike plate and dust box included.

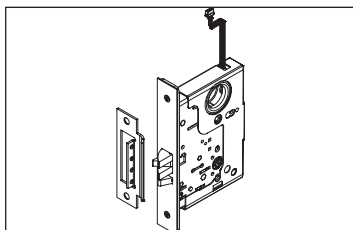

Prices - Gross prices	€
LA1T07 mortise lock for ÆElement - IM finish	168,95
LA1T07 mortise lock for ÆElement - PM finish	177,30

Mortise lock	Backset	Front plate shape	Front plate	Detector	Finish	Spindle	Handing
LA1T07 for electronic with electronic or mechanical privacy	70 70mm (2 - 3/4")	A ANSI squared	2 32mm	4 Privacy, handle, door and override detector	IM Satin stainless steel	S 8mm (5/16") Split	RH right hand
			7 27mm				LH left hand
							RR right hand reverse
							LR left hand reverse



The mortise locks are reversible. You can order the correct handing to save time on site
On stock LA1T0770A24IMSRH / LH. For other combinations the delivery date can be different to 4 weeks.

Model TE010

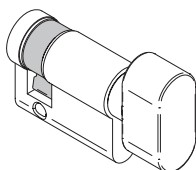

SALTO Privacy thumbturn for ÆElement European.
PZ profile. To be used in combination with the SALTO European mortise lockLE7Sx7.

Prices - Gross prices	€
TE010H - Satin Nickel finish	
TE010H30NM - Thumbturn 30,5mm internal length.	20,75
TE010H35NM - Thumbturn 35,5mm internal length.	22,25
TE010H40NM - Thumbturn 40,5mm internal length.	22,60
TE010H45NM - Thumbturn 45,5mm internal length.	23,90
TE010H50NM - Thumbturn 50,5mm internal length.	24,90
TE010H - Polished Nickel finish	
TE010H30IP - Thumbturn 30,5mm internal length.	20,15
TE010H35IP - Thumbturn 35,5mm internal length.	21,15
TE010H40IP - Thumbturn 40,5mm internal length.	21,95
TE010H45IP - Thumbturn 45,5mm internal length.	23,25
TE010H50IP - Thumbturn 50,5mm internal length.	24,15
TE010H - Satin Brass colour finish	
TE010H30PM - Thumbturn 30,5mm internal length.	28,85
TE010H35PM - Thumbturn 35,5mm internal length.	29,90
TE010H40PM - Thumbturn 40,5mm internal length.	30,40
TE010H45PM - Thumbturn 45,5mm internal length.	32,10
TE010H50PM - Thumbturn 50,5mm internal length.	33,05
TE010H - Polished Brass colour finish	
TE010H30PP - Thumbturn 30,5mm internal length.	28,85
TE010H35PP - Thumbturn 35,5mm internal length.	29,90
TE010H40PP - Thumbturn 40,5mm internal length.	30,40
TE010H45PP - Thumbturn 45,5mm internal length.	32,10
TE010H50PP - Thumbturn 50,5mm internal length.	33,05
TE010H - Black chromium colour finish	
TE010H30NE - Thumbturn 30,5mm internal length.	30,50
TE010H35NE - Thumbturn 35,5mm internal length.	31,75
TE010H40NE - Thumbturn 40,5mm internal length.	33,15
TE010H45NE - Thumbturn 45,5mm internal length.	34,45
TE010H50NE - Thumbturn 50,5mm internal length.	35,80
TE010H - BioCote finish	
TE010H30BC - Thumbturn 30,5mm internal length.	30,50
TE010H35BC - Thumbturn 35,5mm internal length.	31,75
TE010H40BC - Thumbturn 40,5mm internal length.	33,15
TE010H45BC - Thumbturn 45,5mm internal length.	34,45
TE010H50BC - Thumbturn 50,5mm internal length.	35,80

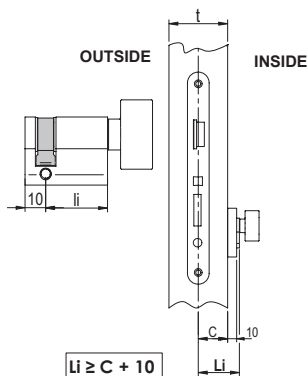

Product	Model	Outside length	Thumbturn	Internal length	Finish
T	E0	10	H	30 (30,5mm)	NM Satin nickel
				35 (35,5mm)	IP Polished nickel plated
				40 (40,5mm)	PM Satin brass colour
				45 (45,5mm)	PP Polished brass colour
				50 (50,5mm)	NE Black chromium
					BC BioCote

Model HT

SALTO Rose Accessory model HT
Round rose, with PZ cut out on the inside to be used with TE010 privacy thumbturn.

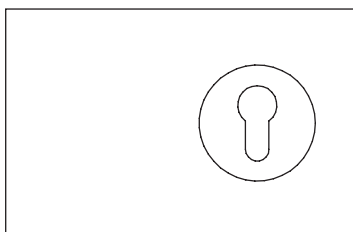

Available for European mortise locks.

Prices - Gross prices		€
Description	Reference	
SALTO Rose model HT - satin stainless steel type finish	R S H T R I M	11,50
SALTO Rose model HT-Bright stainless steel type finish	R S H T R I P	12,55
SALTO Rose model HT - PVD bright brass type finish	R S H T R P P	20,75
SALTO Rose model HT - PVD satin brass type finish	R S H T R P M	19,90
SALTO Rose model HT - Antique brass type finish	R S H T R I A	18,45
SALTO Rose model HT - Black chromium type finish	R S H T R N E	18,45
SALTO Rose model HT - BioCote type finish	R S H T R B C	20,75



Rose	Manufacturer	Model	Format	Finish
R	S SALTO	HT	R Round	IM
				IP
				PP
				PM
				IA
				NE
				BC

Model PH

SALTO Rose Accessory model PH
Round rose, with PZ cut out on the outside.

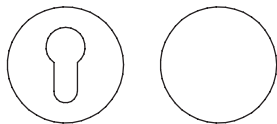

Available for European mortise locks.

Prices - Gross prices		€
Description	Reference	
SALTO Rose model PH - satin stainless steel type finish	R S P H R I M 3	11,50
SALTO Rose model PH-Bright stainless steel type finish	R S P H R I P 3	12,55
SALTO Rose model PH - PVD bright brass type finish	R S P H R P P 3	20,75
SALTO Rose model PH- PVD satin brass type finish	R S P H R P M 3	19,90
SALTO Rose model PH - Antique brass type finish	R S P H R I A 3	18,45
SALTO Rose model PH - Black chromium type finish	R S P H R N E 3	18,45
SALTO Rose model PH - BioCote type finish	R S P H R B C 3	20,75



IM
Satin stainless steel
type

Rose	Manufacturer	Model	Format	Finish	Door thickness
R	S SALTO	PH	R	IM	3 37 < t < 50mm
				IP	
				PP	
				PM	
				IA	5 50 < t < 70mm
				NE	
				BC	

Model PZ

SALTO Rose Accessory model PZ
Round rose, with PZ cut out on the outside and on the inside.

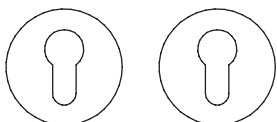

Available for European mortise locks.

Prices - Gross prices		€
Description	Reference	
SALTO Rose model PZ - satin stainless steel type finish	R S P Z R I M 3	11,50
SALTO Rose model PZ-Bright stainless steel type finish	R S P Z R I P 3	12,55
SALTO Rose model PZ - PVD bright brass type finish	R S P Z R P P 3	20,75
SALTO Rose model PZ- PVD satin brass type finish	R S P Z R P M 3	19,90
SALTO Rose model PZ - Antique brass type finish	R S P Z R I A 3	18,45
SALTO Rose model PZ - Black chromium type finish	R S P Z R N E 3	18,45
SALTO Rose model PZ - BioCote type finish	R S P Z R B C 3	20,75



IM
Satin stainless steel
type

Rose	Manufacturer	Model	Format	Finish	Door thickness
R	S SALTO	PZ	R	IM	3 37 < t < 50mm
				IP	
				PP	
				PM	
				IA	5 50 < t < 70mm
				NE	
				BC	

Element Handles



SALTO handles reference example

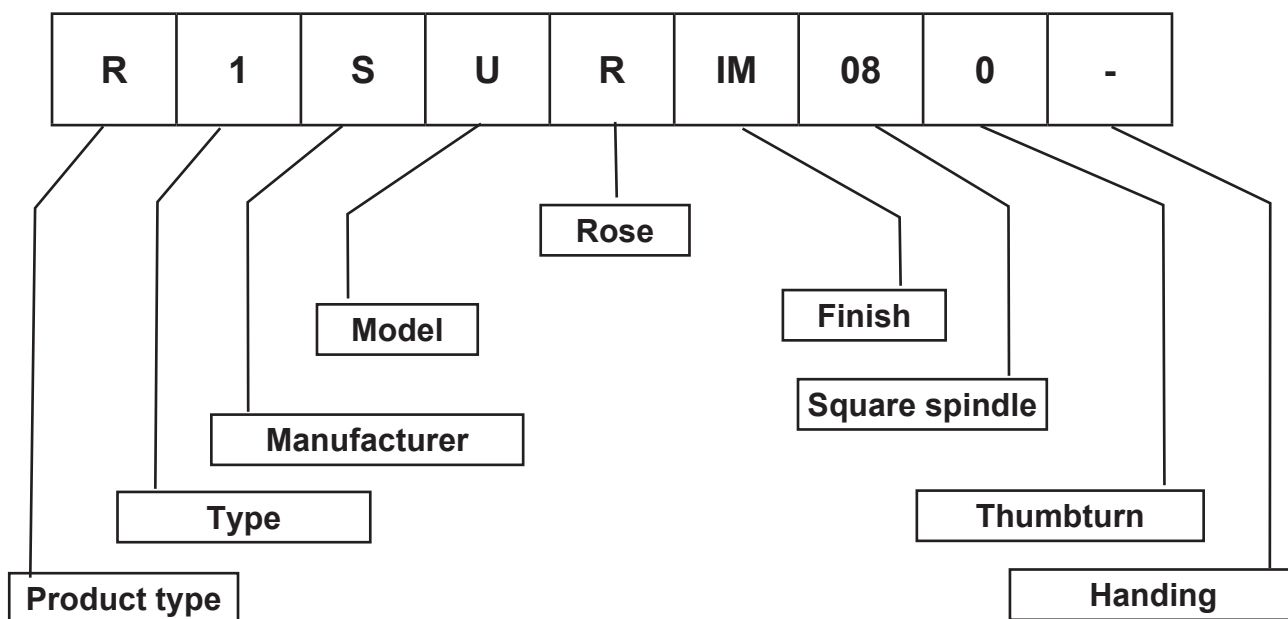

Product type R = Rose	Type 1 = Euro 3 = ANSI 0 = COLOMBO	Manufacturer S = SALTO C = COLOMBO
---------------------------------	--	---

Models - SALTO J= J handle U = U handle L = L handle W = W handle O = O handle K = Kingston handle N = N handle S = S handle T = T handle	Models - COLOMBO 2 = Robodue handle 3 = Robotre handle 4 = Roboquattro handle 5 = Elle handle 7 = Mach handle	Rose R = Round S = Square (only for COLOMBO handles)
---	---	---

Finish IM = Satin stainless steel type PP = PVD bright brass type (US3) IP = Polished stainless steel type NE = Black Chromium (BHMA687) IA = Antique brass type (US5) BC = Biocote PM = PVD satin brass type (US4)	Please note that brass finishes may become discoloured over time due to their exposure to environmental conditions such as humidity, pollution and salt air. Rings and keys can also scratch the brass lacquer finish and once this has started to occur, discolouration will likely begin.
---	--

Square spindle 07 =7mm (just for Euro complementary models) 08 =8mm 09 =9mm (just for Euro models)	Thumbturn 0 = Without thumbturn 1 = SALTO type thumbturn	Handing - = no handing L = Left hand R = Right hand
--	---	---

ÆElement Handles

Model U

SALTO U handle for ÆElement handle set.

Round rose. To be fitted with the split spindle provided with the ÆElement electronics.
2 handles set.

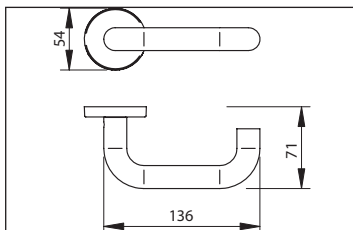

Available for European and ANSI mortise locks.

For complementary doors, without electronics, a special spindles and screws pack needs to be ordered separately. See last page.



IM
Satin stainless steel
type

Prices - Gross prices

Description	Reference	€
SALTO U handle satin stainless steel type finish - 8mm	R x S U R I M 0 x x	54,80
SALTO U handle bright stainless steel type finish - 8mm	R x S U R I P 0 x x	55,45
SALTO U handle PVD bright brass type finish - 8mm	R x S U R P P 0 x x	78,50
SALTO U handle PVD satin brass type finish - 8mm	R x S U R P M 0 x x	68,90
SALTO U handle antique brass type finish - 8mm	R x S U R I A 0 x x -	75,70
SALTO U handle chromium black type finish - 8mm	R x S U R N E 0 x x -	66,95
SALTO U handle Biocote type finish - 8mm	R x S U R B C 0 x x	78,50

Model	Rose	Finish	Square spindle	Thumbturn	Handing
R1SU For European mortise locks	R	IM	08 8mm	0	- no handing reversible
		IP			
		PP			
		PM	09 9mm		
		IA			
		NE			
BC					
R3SU For ANSI mortise locks	R	IM	08 8mm	0 no thumbturn	- no handing reversible
		IP			
		PP			
		PM			
		IA		1 with thumbturn	
		NE			
		BC			

ÆElement Handles

Model E

SALTO E handle for ÆElement handle set.

Round rose. To be fitted with the split spindle provided with the ÆElement electronics.
2 handles set.

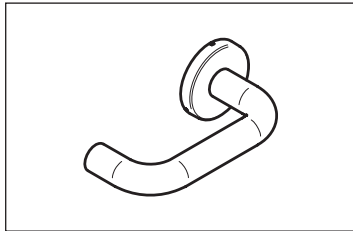

Available for European and ANSI mortise locks.

For complementary doors, without electronics, a special spindles and screws pack needs to be ordered separately. See last page.



IM
Satin stainless steel
type

Prices - Gross prices

Description	Reference	€
SALTO E handle satin stainless steel type finish - 8mm	R x S E R I M 0 8 x	53,60
SALTO E handle bright stainless steel type finish - 8mm	R x S E R I P 0 8 x	56,25
SALTO E handle PVD bright brass type finish - 8mm	R x S E R P P 0 8 x	80,70
SALTO E handle PVD satin brass type finish - 8mm	R x S E R P M 0 8 x	80,00
SALTO E handle antique brass type finish - 8mm	R x S E R I A 0 8 x	76,50
SALTO E handle chromium black type finish - 8mm	R x S E R N E 0 8 x	67,70
SALTO E handle Biocote type finish - 8mm	R x S E R B C 0 8 x	80,70

Model	Rose	Finish	Square spindle	Thumbturn	Handing
R1SE For European mortise locks	R	IM	08 8mm	0	- no handing reversible
		IP			
		PP			
		PM	09 9mm		
		IA			
		NE			
		BC			
R3SE For ANSI mortise locks	R	IM	08 8mm	0 no thumbturn	- no handing reversible
		IP			
		PP			
		PM		1 with thumbturn	
		IA			
		NE			
		BC			

Model G

SALTO G handle for ÆElement handle set.

Round rose. To be fitted with the split spindle provided with the ÆElement electronics.
2 handles set.

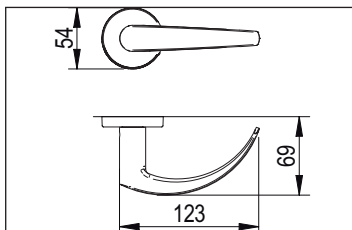

Available for European and ANSI mortise locks.

For complementary doors, without electronics, a special spindles and screws pack needs to be ordered separately. See last page.



IM
Satin stainless steel
type

Prices - Gross prices

Description	Reference	€
SALTO G handle satin stainless steel type finish - 8mm	R x S G R I M 0 8 x	82,70
SALTO G handle PVD satin brass type finish - 8mm	R x S G R P M 0 8 x	89,40
SALTO G handle chromium black type finish - 8mm	R x S G R N E 0 8 x	96,85
SALTO G handle Biocote type finish - 8mm	R x S G R B C 0 8 x	112,45

Model	Rose	Finish	Square spindle	Thumbturn	Handing
R1SG For European mortise locks	R	IM	08 8mm	0 no thumbturn	- no handing reversible
		PM			
		NE			
		BC			
R3SG For ANSI mortise locks	R	IM	08 8mm	0 no thumbturn	- no handing reversible
		PM			
		NE		1 with thumbturn	
		BC			

Model J

SALTO J handle for ÆElement handle set.

Round rose. To be fitted with the split spindle provided with the ÆElement electronics.
2 handles set.

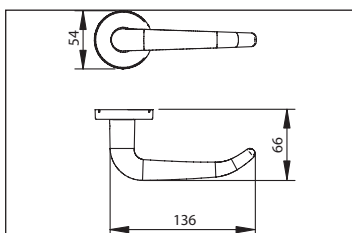

Available for European and ANSI mortise locks.

For complementary doors, without electronics, a special spindles and screws pack needs to be ordered separately. See last page.



IM
Satin stainless steel
type

Prices - Gross prices

Description	Reference	€
SALTO J handle satin stainless steel type finish - 8mm	R x S J R I M 0 8 x	65,90
SALTO J handle PVD satin brass type finish - 8mm	R x S J R P M 0 8 x	90,85
SALTO J handle antique brass type finish - 8mm	R x S J R I A 0 8 x	88,75
SALTO J handle chromium black type finish - 8mm	R x S J R N E 0 8 x	80,00
SALTO J handle Biocote type finish - 8mm	R x S J R B C 0 8 x	90,85

Model	Rose	Finish	Square Spindle	Thumbturn	Handing
R1SJ For European mortise locks	R	IM	08 8mm	0 no thumbturn	- no handing reversible
		PM			
		IA			
		NE			
		BC			
R3SJ For ANSI mortise locks	R	IM	08 8mm	0 no thumbturn	- no handing reversible
		PM			
		IA		1 with thumbturn	
		NE			
		BC			

ÆElement Handles

Model L

SALTO L handle for ÆElement handle set.

Round rose. To be fitted with the split spindle provided with the ÆElement electronics.
2 handles set.

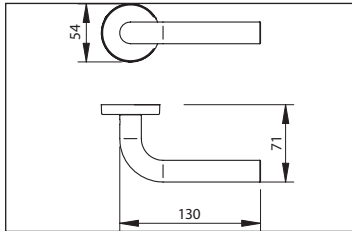

Available for European and ANSI mortise locks.

For complementary doors, without electronics, a special spindles and screws pack needs to be ordered separately. See last page.



IM
Satin stainless steel
type

Prices - Gross prices		€
Description	Reference	
SALTO L handle satin stainless steel type finish - 8mm	R x S L R I M 0 x x	54,80
SALTO L handle bright stainless steel type finish - 8mm	R x S L R I P 0 x x	55,45
SALTO L handle PVD bright brass type finish - 8mm	R x S L R P P 0 x x	78,50
SALTO L handle PVD satin brass type finish - 8mm	R x S L R P M 0 x x	68,90
SALTO L handle antique brass type finish - 8mm	R x S L R I A 0 x x	75,70
SALTO L handle chromium black type finish - 8mm	R x S L R N E 0 x x	66,95
SALTO L handle Biocote type finish - 8mm	R x S L R B C 0 x x	78,50

Model	Rose	Finish	Square spindle	Thumbturn	Handing
R1SL For European mortise locks	R	IM	08 8mm	0	- no handing reversible
		IP			
		PP			
		PM	09 9mm		
		IA			
		NE			
		BC			
R3SL For ANSI mortise locks	R	IM	08 8mm	0 no thumbturn	- no handing reversible
		IP			
		PP			
		PM			
		IA		1 with thumbturn	
		NE			
		BC			

ÆElement Handles

Model O

SALTO O handle for ÆElement handle set.

Round rose. To be fitted with the split spindle provided with the ÆElement electronics.
2 handles set.

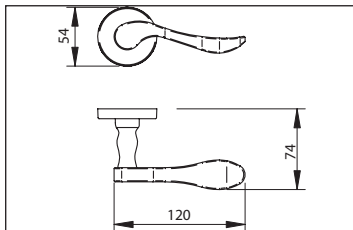

Available for European and ANSI mortise locks.

For complementary doors, without electronics, a special spindles and screws pack needs to be ordered separately. See last page.



IM
Satin stainless steel
type

Prices - Gross prices		€
Description	Reference	
SALTO O handle satin stainless steel type finish - 8mm	R x S O R I M 0 8 x x	81,35
SALTO O handle bright stainless steel type finish - 8mm	R x S O R I P 0 8 x x	66,70
SALTO O handle PVD bright brass type finish - 8mm	R x S O R P P 0 8 x x	89,80
SALTO O handle PVD satin brass type finish - 8mm	R x S O R P M 0 8 x x	91,65
SALTO O handle antique brass type finish - 8mm	R x S O R I A 0 8 x x	89,60
SALTO O handle chromium black type finish - 8mm	R x S O R N E 0 8 x x	86,60

Model	Rose	Finish	Square spindle	Thumbturn	Handing
R1SO For European mortise locks	R	IM	08 8mm	0 no thumbturn	L left hand
		IP			
		PP			
		PM			R right hand
		IA			
NE					
R3SO For ANSI mortise locks	R	IM	08 8mm	0 no thumbturn	L left hand
		IP			
		PP		1 with thumbturn	R right hand
		PM			
		IA			
NE					

ÆElement Handles

Model S

SALTO S handle for ÆElement handle set.

Round rose. To be fitted with the split spindle provided with the ÆElement electronics.
2 handles set.

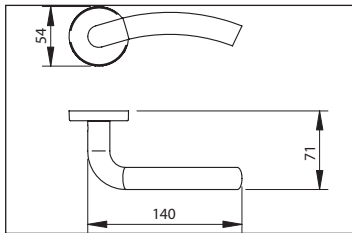

Available for European and ANSI mortise locks.

For complementary doors, without electronics, a special spindles and screws pack needs to be ordered separately. See last page.



IM
Satin stainless steel
type

Prices - Gross prices

Description	Reference	€
SALTO S handle satin stainless steel type finish - 8mm	R x S S R I M 0 8 x x	55,60
SALTO S handle chromium black type finish - 8mm	R x S S R N E 0 8 x x	69,70
SALTO S handle Biocote type finish - 8mm	R x S S R B C 0 8 x x	86,75

Model	Rose	Finish	Square spindle	Thumbturn	Handing
R1SS For European mortise locks	R	IM	08 8mm	0 no thumbturn	L left hand
		NE			R right hand
		BC			
R3SS For ANSI mortise locks	R	IM	08 8mm	0 no thumbturn	L left hand
		NE		1 with thumbturn	R right hand
		BC			

Model T

SALTO T handle for ÆElement handle set.

Round rose. To be fitted with the split spindle provided with the ÆElement electronics.
2 handles set.

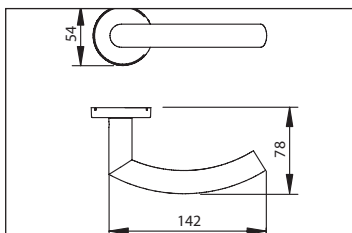

Available for European and ANSI mortise locks.

For complementary doors, without electronics, a special spindles and screws pack needs to be ordered separately. See last page.



IM
Satin stainless steel
type

Prices - Gross prices

Description	Reference	€
SALTO T handle satin stainless steel type finish - 8mm	R x S T R I M 0 8 x	56,10
SALTO T handle PVD satin brass type finish - 8mm	R x S T R P M 0 8 x	123,35
SALTO T handle chromium black type finish - 8mm	R x S T R N E 0 8 x	70,20
SALTO T handle Biocote type finish - 8mm	R x S T R B C 0 8 x	123,35

Model	Rose	Finish	Square spindle	Thumbturn	Handing
R1ST For European mortise locks	R	IM	08 8mm	0 no thumbturn	- no handing reversible
		PM			
		NE			
		BC			
R3ST For ANSI mortise locks	R	IM	08 8mm	0 no thumbturn	- no handing reversible
		PM		1 with thumbturn	
		NE			
		BC			

ÆElement Handles

Model K

SALTO K handle for ÆElement handle set.

Round rose. To be fitted with the split spindle provided with the ÆElement electronics.
2 handles set.

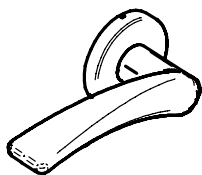

Just compatible with ÆElement European and ANSI mortise locks.

For complementary doors, without electronics, a special spindles and screws pack needs to be ordered separately. See last page.



IM
Satin stainless steel type

Prices - Gross prices

Description	Reference	€
SALTO K handle satin stainless steel type finish - 8mm	R x S K R I M 0 x 0 -	81,35
SALTO K handle bright stainless steel type finish - 8mm	R x S K R I P 0 x 0 -	66,70
SALTO K handle PVD bright brass type finish - 8mm	R x S K R P P 0 x 0 -	89,80

Model	Rose	Finish	Square spindle	Thumbturn	Handing
R1SK For European mortise locks	R	IM	08 8mm	0 no thumbturn	L left hand
		IP			R right hand
		PP (PVD)			
R3SK For ANSI mortise locks	R	IM	08 8mm	0 no thumbturn	L left hand
		IP		1 with thumbturn	R right hand
		PP (PVD)			

Model W

SALTO W handle for ÆElement handle set.

Round rose. To be fitted with the split spindle provided with the ÆElement electronics.
2 handles set.

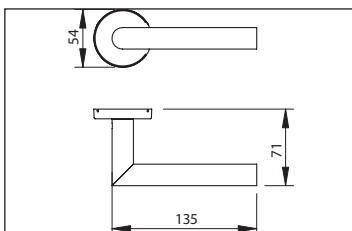

Available for European and ANSI mortise locks.

For complementary doors, without electronics, a special spindles and screws pack needs to be ordered separately. See last page.



IM
Satin stainless steel type

Prices - Gross prices

Description	Reference	€
SALTO W handle satin stainless steel type finish - 8mm	R x S W R I M 0 x x	54,80
SALTO W handle bright stainless steel type finish - 8mm	R x S W R I P 0 x x	55,45
SALTO W handle PVD bright brass type finish - 8mm	R x S W R P P 0 x x	78,50
SALTO W handle PVD satin brass type finish - 8mm	R x S W R P M 0 x x	68,90
SALTO W handle antique brass type finish - 8mm	R x S W R I A 0 x x	75,70
SALTO W handle chromium black type finish - 8mm	R x S W R N E 0 x x	66,95
SALTO W handle Biocote type finish - 8mm	R x S W R B C 0 x x	78,50

Model	Rose	Finish	Square spindle	Thumbturn	Handing
R1SW For European mortise locks	R	IM	08 8mm	0	- no handing reversible
		IP			
		PP			
		PM	09 9mm		
		IA			
		NE			
R3SW For ANSI mortise locks	R	IM	08 8mm	0 no thumbturn	- no handing reversible
		IP		1 with thumbturn	
		PP			
		PM			
		IA			
		NE			
BC					

ÆElement Handles

Model N

SALTO N handle for ÆElement handle set.
Round rose. To be fitted with the split spindle provided with the ÆElement electronics.
2 handles set.

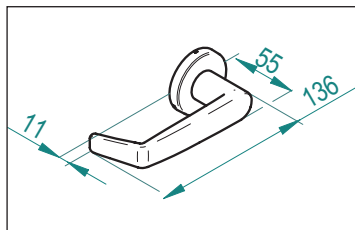

Available for European and ANSI mortise locks.

For complementary doors, without electronics, a special spindles and screws pack needs to be ordered separately. See last page.



IM
Satin stainless steel
type

Prices - Gross prices

€

Description	Reference
SALTO N handle satin stainless steel type finish - 8mm	R x S N R I M 0 8 0
SALTO N handle PVD satin brass type finish - 8mm	R x S N R P M 0 8 0
SALTO N handle chromium black type finish - 8mm	R x S N R N E 0 8 0
SALTO N handle Biocote type finish - 8mm	R x S N R B C 0 8 0

78,75

91,65

92,90

92,90

Model	Rose	Finish	Square spindle	Thumbturn	Handing
R1SN For European mortise locks	R	IM	08 8mm	0 no thumbturn	- no handing reversible
		PM			
		NE			
		BC			
R3SN For ANSI mortise locks	R	IM	08 8mm	0 no thumbturn	- no handing reversible
		PM		1 with thumbturn	
		NE			
		BC			

Model Z

SALTO Z handle for ÆElement handle set.
Round rose. To be fitted with the split spindle provided with the ÆElement electronics.
2 handles set.

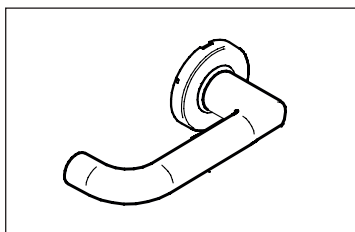

Available for European and ANSI mortise locks.

For complementary doors, without electronics, a special spindles and screws pack needs to be ordered separately. See last page.

Prices - Gross prices

€

Description	Reference
SALTO Z handle satin stainless steel type finish - 8mm	R x S Z R I M 0 8 x
SALTO Z handle PVD satin brass type finish - 8mm	R x S Z R P M 0 8 x
SALTO Z handle chromium black type finish - 8mm	R x S Z R N E 0 8 x
SALTO Z handle Biocote type finish - 8mm	R x S Z R B C 0 8 x

55,85

82,25

69,90

82,25

Model	Rose	Finish	Square spindle	Thumbturn	Handing
R1SZ For European mortise locks	R	IM	08 8mm	0 no thumbturn	- no handing reversible
		PM			
		NE			
		BC			
R3SZ For ANSI mortise locks	R	IM	08 8mm	0 no thumbturn	- no handing reversible
		PM		1 with thumbturn	
		NE			
		BC			

Model 2 (Robodue)

Robodue handle for ÆElement handle set.
 Round or square rose. 8mm spindle handle.
 To be fitted with the split spindle provided with the ÆElement electronics.

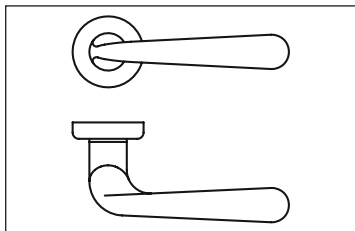

Prices - Gross prices		€
Description	Reference	
Colombo Robodue handle satin stainless steel type finish	R 0 C 2 x I M 0 8 0 -	117,15
Colombo Robodue handle bright stainless steel type finish	R 0 C 2 x I P 0 8 0 -	117,15
Colombo Robodue handle PVD bright brass type finish	R 0 C 2 x P P 0 8 0 -	117,15

For complementary doors, without electronics, a special spindles and screws pack need to be ordered separately. See last page.

Delivery date 6 weeks



IM
Satin stainless steel type

Model	Rose	Finish	Square spindle	Thumbturn	Handing
R0C2	R Round	IM	08 8mm	0 no thumbturn	- no handing reversible
		IP		1 SALTO ANSI thumbturn	
	S Square	PP (PVD)			

Model 3 (Robotre)

Robotre handle for ÆElement handle set.
 Round or square rose. 8mm spindle handle.
 To be fitted with the split spindle provided with the ÆElement electronics.

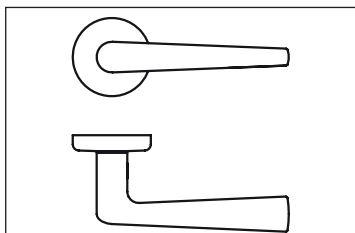

Prices - Gross prices		€
Description	Reference	
Colombo Robotre handle satin stainless steel type finish	R 0 C 3 x I M 0 8 0 -	117,15
Colombo Robotre handle bright stainless steel type finish	R 0 C 3 x I P 0 8 0 -	117,15
Colombo Robotre handle PVD bright brass type finish	R 0 C 3 x P P 0 8 0 -	117,15

For complementary doors, without electronics, a special spindles and screws pack need to be ordered separately. See last page.

Delivery date 6 weeks



IP
Polished stainless steel type

Model	Rose	Finish	Square spindle	Thumbturn	Handing
R0C3	R Round	IM	08 8mm	0 no thumbturn	- no handing reversible
		IP		1 SALTO ANSI thumbturn	
	S Square	PP (PVD)			

Model 4 (Roboquattro)

Roboquattro handle for ÆElement handle set.
Round or square rose. 8mm spindle handle.
To be fitted with the split spindle provided with the ÆElement electronics.

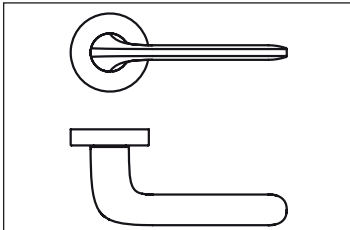

Prices - Gross prices		€
Description	Reference	
Colombo Roboquattro handle satin stainless steel type finish	R 0 C 4 x I M 0 8 0 -	117,15
Colombo Roboquattro handle bright stainless steel type finish	R 0 C 4 x I P 0 8 0 -	117,15
Colombo Roboquattro handle PVD bright brass type finish	R 0 C 4 x P P 0 8 0 -	117,15

For complementary doors, without electronics, a special spindles and screws pack need to be ordered separately. See last page.

Delivery date 6 weeks



IM
Satin stainless steel type

Model	Rose	Finish	Square spindle	Thumbturn	Handing
R0C4	R Round	IM	08 8mm	0 no thumbturn	- no handing reversible
		IP		1 SALTO ANSI thumbturn	
	S Square	PP (PVD)			

Model 5 (Elle)

Elle handle for ÆElement handle set.
Round or square rose. 8mm spindle handle.
To be fitted with the split spindle provided with the ÆElement electronics.

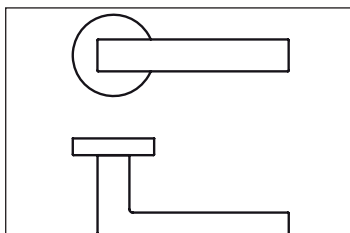

Prices - Gross prices		€
Description	Reference	
Colombo Elle handle satin stainless steel type finish	R 0 C 5 x I M 0 8 0 -	117,15
Colombo Elle handle bright stainless steel type finish	R 0 C 5 x I P 0 8 0 -	117,15
Colombo Elle handle PVD bright brass type finish	R 0 C 5 x P P 0 8 0 -	117,15

For complementary doors, without electronic, a special spindles and screws pack need to be ordered separately. See last page.

Delivery date 6 weeks



IM
Satin stainless steel type

Model	Rose	Finish	Square spindle	Thumbturn	Handing
R0C5	R Round	IM	08 8mm	0 no thumbturn	- no handing reversible
		IP		1 SALTO ANSI thumbturn	
	S Square	PP (PVD)			

Model Mach

Mach handle for ÆElement handle set.
Round or square rose. 8mm spindle handle.
To be fitted with the split spindle provided with the ÆElement electronics.

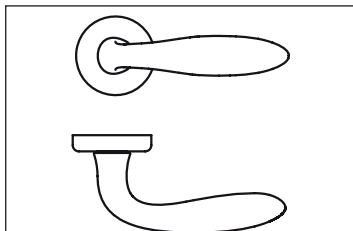

Prices - Gross prices		€
Description	Reference	
Colombo Mach handle satin stainless steel type finish	R 0 C 7 x I M 0 8 0 -	117,15
Colombo Mach handle bright stainless steel type finish	R 0 C 7 x I P 0 8 0 -	117,15
Colombo Mach handle PVD bright brass type finish	R 0 C 7 x P P 0 8 0 -	117,15

For complementary doors, without electronics, a special spindles and screws pack need to be ordered separately. See last page.

Delivery date 6 weeks

Model	Rose	Finish	Square spindle	Thumbturn	Handing
R0C7	R	IM	08 8mm	0	- no handing reversible
	Round	IP		no thumbturn	
	S	PP (PVD)		1	
	Square			SALTO ANSI thumbturn	

Element SALTO handles accessories

**Screws bag
(complementary doors)**

Screw bag with with screws, spindles, sockets and extenders, for complementary doors.
Componets to fit a handle in a door without electronics. (pack of 10 units)

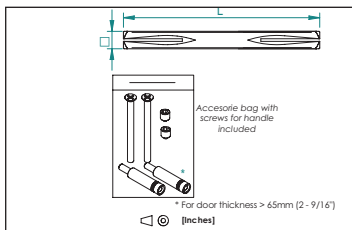

This product is not subject to the hotel discount.

(pack of 10 units).

Prices - Gross prices		€
Description	Reference	
Screws for 8mm spindles, length 100mm, door thickness35-45mm.	SP310459-C8-310	100,70
Screws for 8mm spindles, length 110mm, door thickness45-55mm.	SP310459-C8-410	100,70
Screws for 8mm spindles, length 110mm, door thickness55-65mm.	SP310459-C8-510	100,70
Screws for 8mm spindles, length 120mm, door thickness65-75mm.	SP310459-C8-610	100,70
Screws for 8mm spindles, length 140mm, door thickness75-85mm.	SP310459-C8-710	172,60
Screws for 8mm spindles, length 140mm, door thickness85-95mm.	SP310459-C8-810	172,60
Screws for 8mm spindles, length 160mm, door thickness95-105mm.	SP310459-C8-910	172,60
Screws for 8mm spindles, length 160mm, door thickness105-115mm.	SP310459-C8-010	172,60
Screws for 8mm spindles, length 170mm, door thickness115-125mm.	SP310459-C8-110	172,60
Screws for 9mm spindles, length 100mm, door thickness35-45mm.	SP310460-C9-310	115,10
Screws for 9mm spindles, length 110mm, door thickness45-55mm.	SP310460-C9-410	115,10
Screws for 9mm spindles, length 110mm, door thickness55-65mm.	SP310460-C9-510	115,10
Screws for 9mm spindles, length 120mm, door thickness65-75mm.	SP310460-C9-610	172,60
Screws for 9mm spindles, length 140mm, door thickness75-85mm.	SP310460-C9-710	172,60
Screws for 9mm spindles, length 140mm, door thickness85-95mm.	SP310460-C9-810	172,60
Screws for 9mm spindles, length 160mm, door thickness95-105mm.	SP310460-C9-910	172,60
Screws for 9mm spindles, length 160mm, door thickness105-115mm.	SP310460-C9-010	172,60
Screws for 9mm spindles, length 170mm, door thickness115-125mm.	SP310460-C9-110	172,60

SPINDLES FOR COMPLEMENTARY LEVERS

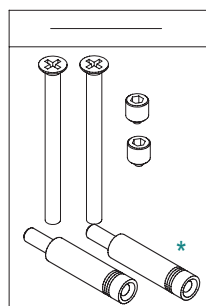
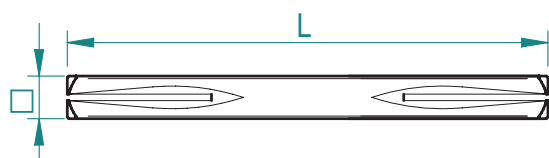

Accessorie bag with screws for handle included

* For door thickness > 65mm (2 - 9/16")

[Inches]

SALTO ÆElement roses accessories reference example:

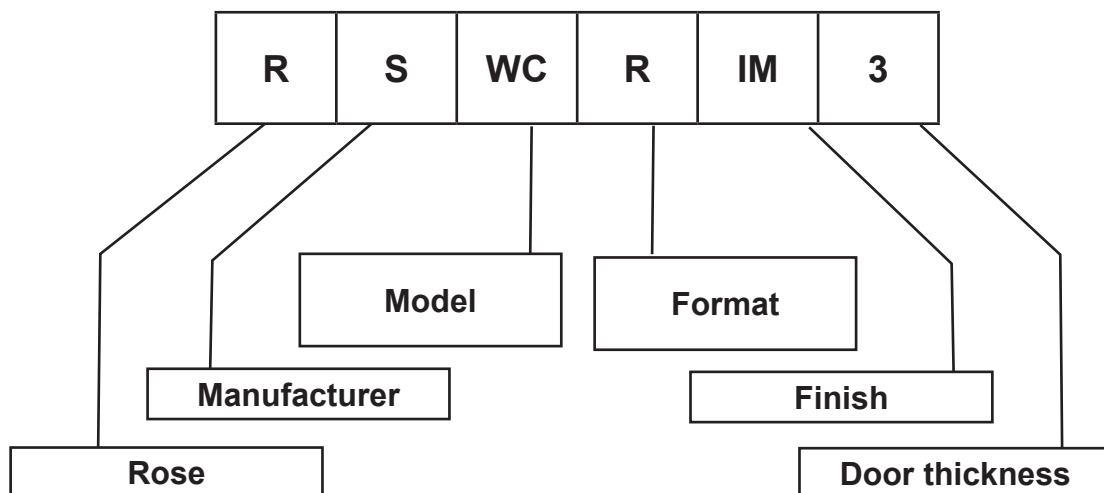

Rose

R = ÆElement rose

Manufacturer

S= SALTO

Model

WC
PH
PZ

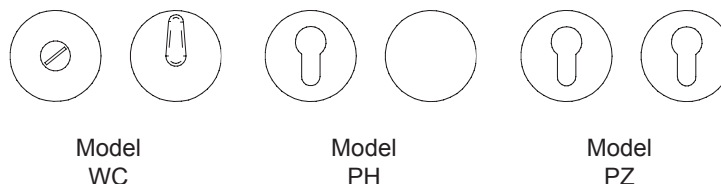

Model
WC

Model
PH

Model
PZ

Format

R = Round
S = Squared

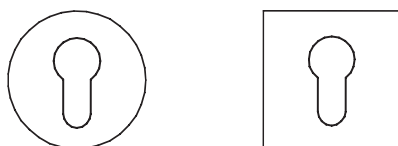

Format
Round

Format
Squared

Finishes

IM = Satin stainless steels (BHMA630 - US32D)
IP = Bright stainless steel (BHMA629 - US32)
IA = Old brass type (BHMA609 - US5)
PP = Bright brass Type (US3)
PM =Satin brass Type (US4)
NE = Black chomium
BC = BioCote

Door thickness

3 = 37 < t < 50mm
5 = 50 < t < 70mm

Model PH

SALTO Rose Accessory model PH
Round rose, with PZ cut out on the outside.

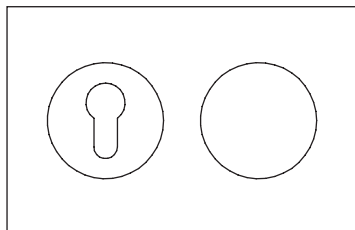

Available for European mortise locks.

Prices - Gross prices		€
Description	Reference	
SALTO Rose model PH - satin stainless steel type finish	R S P H R I M 3	11,50
SALTO Rose model PH-Bright stainless steel type finish	R S P H R I P 3	12,55
SALTO Rose model PH - PVD bright brass type finish	R S P H R P P 3	20,75
SALTO Rose model PH- PVD satin brass type finish	R S P H R P M 3	19,90
SALTO Rose model PH - Antique brass type finish	R S P H R I A 3	18,45
SALTO Rose model PH - Black chromium type finish	R S P H R N E 3	18,45
SALTO Rose model PH - BioCote type finish	R S P H R B C 3	20,75



IM
Satin stainless steel
type

Rose	Manufacturer	Model	Format	Finish	Door thickness
R	S SALTO	PH	R	IM	3 37 < t < 50mm
				IP	
				PP	
				PM	
				IA	5 50 < t < 70mm
				NE	
				BC	
				BC	

Model PZ

SALTO Rose Accessory model PZ
Round rose, with PZ cut out on the outside and on the inside.

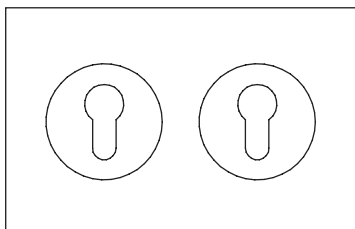

Available for European mortise locks.

Prices - Gross prices		€
Description	Reference	
SALTO Rose model PZ - satin stainless steel type finish	R S P Z R I M 3	11,50
SALTO Rose model PZ-Bright stainless steel type finish	R S P Z R I P 3	12,55
SALTO Rose model PZ - PVD bright brass type finish	R S P Z R P P 3	20,75
SALTO Rose model PZ- PVD satin brass type finish	R S P Z R P M 3	19,90
SALTO Rose model PZ - Antique brass type finish	R S P Z R I A 3	18,45
SALTO Rose model PZ - Black chromium type finish	R S P Z R N E 3	18,45
SALTO Rose model PZ - BioCote type finish	R S P Z R B C 3	20,75



IM
Satin stainless steel
type

Rose	Manufacturer	Model	Format	Finish	Door thickness
R	S SALTO	PZ	R	IM	3 37 < t < 50mm
				IP	
				PP	
				PM	
				IA	5 50 < t < 70mm
				NE	
				BC	
				BC	

Model WC

SALTO Rose Accessory model WC
Round rose, with coin emergency override.

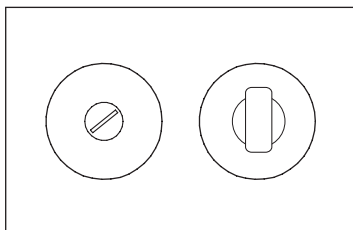

Available for European mortise locks.

For complementary doors, without electronics.

Includes 6mm spindle and an 8mm adaptor and screws pack.



IM
Satin stainless steel type

Prices - Gross prices		€
Description	Reference	
SALTO Rose model WC - satin stainless steel type finish	R S W C R I M x	31,05
SALTO Rose model WC - Bright stainless steel type finish	R S W C R I P x	31,90
SALTO Rose model WC - PVD bright brass type finish	R S W C R P P x	40,30
SALTO Rose model WC - PVD satin brass type finish	R S W C R P M x	39,55
SALTO Rose model WC - Antique brass type finish	R S W C R I A x	37,75
SALTO Rose model WC - Black chromium type finish	R S W C R N E x	37,75
SALTO Rose model WC - BioCote type finish	R S W C R B C x	40,30

Rose	Manufacturer	Model	Format	Finish	Door thickness
R	S SALTO	WC	R Round	IM	3 37 < t < 50mm
				IP	
				PP	
				PM	
				IA	5 50 < t < 70mm
				NE	
				BC	

Model PX

SALTO Rose Accessory model PX
Round rose, with PX cut out on the outside.

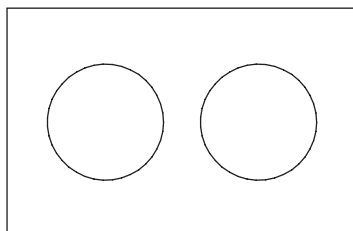

Available for European mortise locks.



IM
Satin stainless steel type

Prices - Gross prices		€
Description	Reference	
SALTO Rose model PX - satin stainless steel type finish	R S P X R I M 3	11,50
SALTO Rose model PX - Bright stainless steel type finish	R S P X R I P 3	12,55
SALTO Rose model PX - PVD bright brass type finish	R S P X R P P 3	20,75
SALTO Rose model PX - PVD satin brass type finish	R S P X R P M 3	19,90
SALTO Rose model PX - Antique brass type finish	R S P X R I A 3	18,45
SALTO Rose model PX - Black chromium type finish	R S P X R N E 3	18,45
SALTO Rose model PX - BioCote type finish	R S P X R B C 3	20,75

Rose	Manufacturer	Model	Format	Finish	Door thickness
R	S SALTO	PX	R Round	IM	3 37 < t < 50mm
				IP	
				PP	
				PM	
				IA	5 50 < t < 70mm
				NE	
				BC	

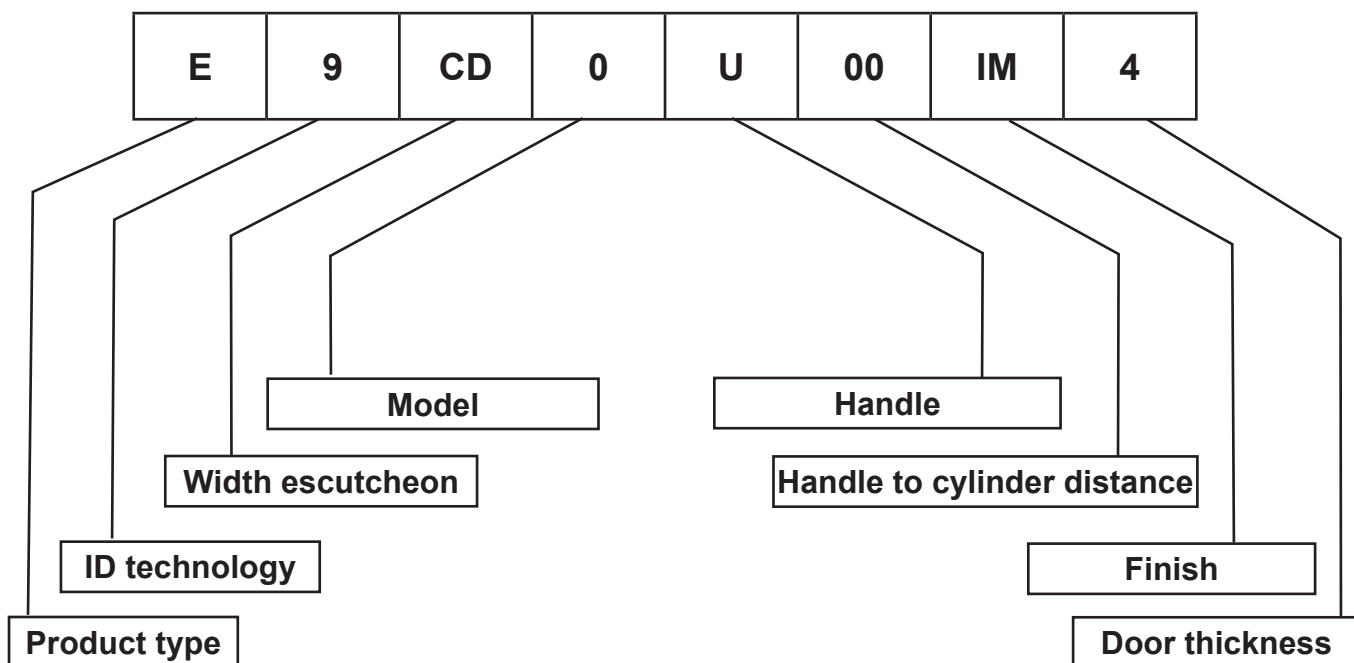

Product type:

- E = European mortise locks.
- F = European mortise locks 9 mm square spindle.

ID technology

RFID

- 7 = Contactless Inside Picopass
- 8 = Contactless Legic
- 9 = Contactless Mifare/DESFire
- H = Contactless iCLASS HID

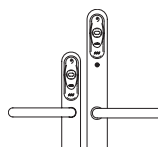

Width escutcheon

CD = Compact Cover Double reader - 37mm. (outside) - 42.5mm. (inside).

Handles

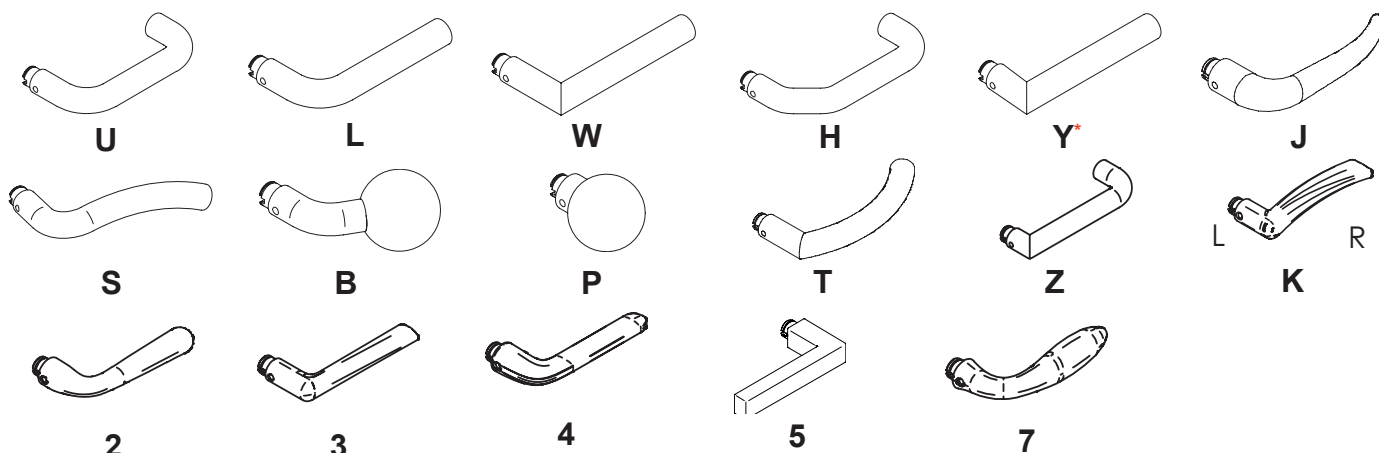

* The Y handle, means Y on the outside and W on the inside.

Distance to cylinder

- | | |
|----------------------------------|----------------------------------|
| 00 = without distance | 85 = 85mm euro profile cylinder |
| 70 = 70mm euro profile cylinder | 88 = 88mm euro profile cylinder |
| 72 = 72mm euro profile cylinder | 90 = 90mm euro profile cylinder |
| 3R = 73.5mm Swiss profile | 92 = 92 mm euro profile cylinder |
| 4R = 74mm Swiss profile | 9R = 94mm swiss profile cylinder |
| 78 = 78mm euro profile cylinder | |
| 7R = 78mm swiss profile cylinder | |

Finishes

- IM = Satin stainless steel NE = Black
IP = Bright stainless steel



Satin stainless steel



Bright stainless steel



Black

Door thickness

TABLE TO DEFINE DOOR THICKNESS FOR EUROPEAN MORTICE LOCKS

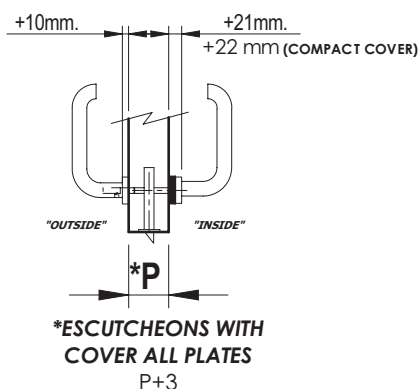

P Door / Puerta m.m.	t REF.
30 < 40	3
40 < 50	4
45 < 55	A
50 < 60	5
60 < 70	6
70 < 80	7
80 < 90	8
90 < 100	9
100 < 110	0
110 < 120	1
SPECIAL	2

Model ExCD0

Electronic Escutcheon, Double reader, 2 handles any type, outside and Inside reader.

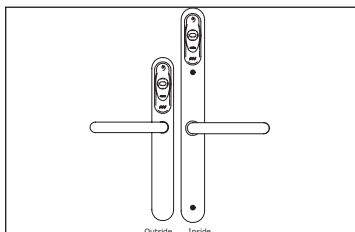

	Prices - Gross prices		€
--	------------------------------	--	---

	Picopass: Double reader model, compact cover, 8mm square spindle, standard handle.	911,70
	Picopass: Double reader model, compact cover, 9mm square spindle, standard handle.	940,45

	Legic: Double reader model, compact cover, 8mm square spindle, standard handle.	868,25
	Legic: Double reader model, compact cover, 9mm square spindle, standard handle.	897,05

MIFARE DESFire	Mifare DESFire: Double reader model, compact cover, 8mm square spindle, standard handle.	868,25
	Mifare DESFire: Double reader model, compact cover, 9mm square spindle, standard handle.	897,05

	HID iCLASS: Double reader model, compact cover, 8mm square spindle, standard handle.	1094,85
	HID iCLASS: Double reader model, compact cover, 9mm square spindle, standard handle.	1123,85

¹ For Handed lever handles, only for S or K handles.

² This option has an additional price please refer to the handles or finishes chapter.

Escutcheon	Technology	Width escutcheon	Model	Handles	Handle to cylinder distances	Finish	Door thickness	
E European mortise lock 8mm square spindle	7 Picopass	CD	0	U	00	IM	3	
				L			4	
				W			A	
				H ²			5	
	Y ²			6				
	8 Legic			B ²		7		
				P ²		8		
				9 Mifare DESFire		J	IP ¹	9
						T		0
						Z		1
K ¹		2						
2 ²	0							
H HID iCLASS	3 ²	NE ¹	1					
	4 ²		2					
	5 ²							
	7 ²							

Model ExCD2

Electronic Escutcheon, Double reader, 2 handles any type, outside and Inside reader, inside/outside cylinder cut out.

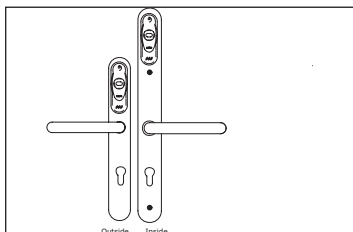

Prices - Gross prices €



Picopass: Double reader model, compact cover, 8mm square spindle, standard handle.	924,90
Picopass: Double reader model, compact cover, 9mm square spindle, standard handle.	953,75



Legic: Double reader model, compact cover, 8mm square spindle, standard handle.	866,05
Legic: Double reader model, compact cover, 9mm square spindle, standard handle.	894,85



Mifare DESFire: Double reader model, compact cover, 8mm square spindle, standard handle.	866,05
Mifare DESFire: Double reader model, compact cover, 9mm square spindle, standard handle.	894,85



HID iCLASS: Double reader model, compact cover, 8mm square spindle, standard handle.	1115,85
HID iCLASS: Double reader model, compact cover, 9mm square spindle, standard handle.	1144,75

¹ For Handed lever handles, only for S or K handles.

² This option has an additional price please refer to the handles or finishes chapter.

Escutcheon	Technology	Width escutcheon	Model	Handles	Handle to cylinder distances	Finish	Door thickness		
E European mortise lock 8mm square spindle	7 Picopass	CD	2	U	70	IM	3		
				L	72		4		
				W			78	A	
				H ²				85	5
				Y ²					IP ¹
	S ^{1,2}			88	7				
	B ²				90	8			
	P ²			92		9			
	J				NE ¹	0			
	T			3R		1			
Z	4R	2							
K ¹		7R							
2 ²	9R								
3 ²									
4 ²									
5 ²									
7 ²									
F European mortise lock 9mm square spindle	9 Mifare DESFire								
	H HID iCLASS								

Model ExCD4

Electronic Escutcheon, Double reader, 2 handles any type, outside and inside reader, outside cylinder cut out.

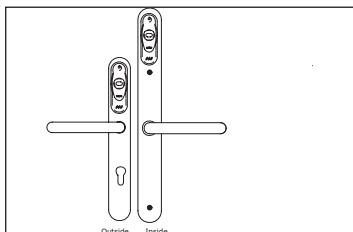

	Prices - Gross prices	€
--	------------------------------	---

	Picopass: Double reader model, compact cover, 8mm square spindle, standard handle.	909,25
	Picopass: Double reader model, compact cover, 9mm square spindle, standard handle.	938,15

	Legic: Double reader model, compact cover, 8mm square spindle, standard handle.	880,90
	Legic: Double reader model, compact cover, 9mm square spindle, standard handle.	909,75

	Mifare DESFire: Double reader model, compact cover, 8mm square spindle, standard handle.	880,90
	Mifare DESFire: Double reader model, compact cover, 9mm square spindle, standard handle.	909,75

	HID iCLASS: Double reader model, compact cover, 8mm square spindle, standard handle.	1121,95
	HID iCLASS: Double reader model, compact cover, 9mm square spindle, standard handle.	1150,75

¹ For Handed lever handles, only for S or K handles.

² This option has an additional price please refer to the handles or finishes chapter.

Escutcheon	Technology	Width escutcheon	Model	Handles	Handle to cylinder distances	Finish	Door thickness
E European mortise lock 8mm square spindle	7 Picopass	CD	4	U	70	IM	3
				L	72		4
				W			A
	H ²			78	IP ¹	5	
	Y ²			85			6
S ^{1,2}	88						
B ²	90			7			
P ²							92
F European mortise lock 9mm square spindle	9 Mifare DESFire			NE ¹	K ¹	3R	9
	H HID iCLASS				2 ²	4R	0
		3 ²	7R		1		
		4 ²			9R	2	
		5 ²					
	7 ²						

Model SxCD0

Electronic Escutcheon, Double reader, SxCD0, 2 handles any type, outside and Inside reader.

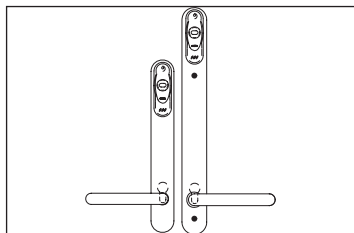

Prices - Gross prices €



Picopass: Double reader model, compact cover, 8mm square spindle, standard handle. 958,05



Legic: Double reader model, compact cover, 8mm square spindle, standard handle. 909,00



Mifare DESFire: Double reader model, compact cover, 8mm square spindle, standard handle. 909,00



HID iCLASS: Double reader model, compact cover, 8mm square spindle, standard handle. 1132,55

¹ For Handed lever handles, only for S or K handles.

² This option has an additional price please refer to the handles or finishes chapter.

Escutcheon	Technology	Width escutcheon	Model	Handles	Handle to cylinder distances	Finish	Door thickness
S	7 Picopass	CD	0	U	00	IM	3
				L			4
				W			5
				H ²			6
	8 Legic			Y ²		IP ¹	7
				S ^{1,2}			8
				B ²			9
				P ²			0
	9 Mifare DESFire			NE ¹		J	1
						T	2
						Z	3
						K ¹	4
	H HID iCLASS					2 ²	5
						3 ²	6
						4 ²	7
						5 ²	8
			6 ²	9			
			7 ²	0			

Model SxCD4

Electronic Escutcheon, Double reader, SxCD4, 2 handles any type, outside and inside reader, outside cylinder cut out.

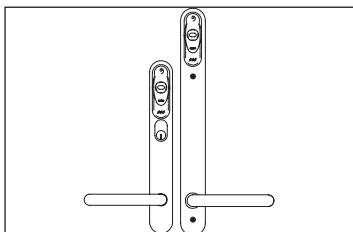

Prices - Gross prices

€



Picopass: Double reader model, compact cover, 8mm square spindle, standard handle.

954,40



Legic: Double reader model, compact cover, 8mm square spindle, standard handle.

912,40



Mifare DESFire: Double reader model, compact cover, 8mm square spindle, standard handle.

912,40





HID iCLASS: Double reader model, compact cover, 8mm square spindle, standard handle.

1153,60

¹ For Handed lever handles, only for S or K handles.

² This option has an additional price please refer to the handles or finishes chapter.

Escutcheon	Technology	Width escutcheon	Model	Handles	Handle to cylinder distances	Finish	Door thickness	
S	7 Picopass	CD	4	U	05	IM	3	
				L			4	
				W			5	
				H ²			6	
	8 Legic			Y ²	65	cylinder protection 6mm	IP ¹	7
				S ^{1,2}				8
				B ²				9
				P ²				0
	9 Mifare DESFire			J	85	cylinder protection 8mm	NE ¹	1
				T				2
				Z				3
				K ¹				4
	H HID iCLASS			2 ²				5
				3 ²				6
				4 ²				7
				5 ²				8
							9	
							0	
							1	
							2	

Product description	Product reference	€
Stainless steel finishes		
Satin stainless steel 	E X X X X X X I M X X	0,00
Polished stainless steel 	E X X X X X X I P X X	15,70
RAL colours		
Black 	E X X X X X X N E X X	24,90

Only those handles regarded as off-set handles have an add-on to the price of the standard escutcheon.
2 remarks:

- Prices are gross and per handle, so an E9CD0 model, for instance, needs 2 handles in the case of an off-set model.
- Prices refer to the IM finish, so please refer to the finishes pricelist in order to establish final price of the product.

FINISH		MODEL	SATIN STAINLESS STEEL	POLISHED STAINLESS STEEL	BLACK	Spindle available			Gross price
			IM	IP	NE	DUAL 8-7diamond 	8 	9 	€
	U	↘	↘	↘			↘	↘	0,00
	L	↘	↘	↘			↘	↘	0,00
	W	↘	↘	↘			↘	↘	0,00
	H	↘		↘			↘	↘	30,15
	S	↘		↘			↘		30,15
	B	↘		↘			↘		71,05
	P	↘		↘			↘		44,35
	J	↘		↘			↘		0,00
	T	↘		↘			↘		0,00
	Y	↘	↘	↘			↘		30,15
	Z	↘		↘			↘		0,00
	K	↘	↘				↘		0,00
	2	↘	↘				↘		37,30
	3	↘	↘				↘		37,30
	4	↘	↘				↘		37,30
	7	↘	↘				↘		37,30
	5	↘	↘				↘		37,30

S and K models are handed models.

* The Y handle, means Y on the outside and W on the inside.



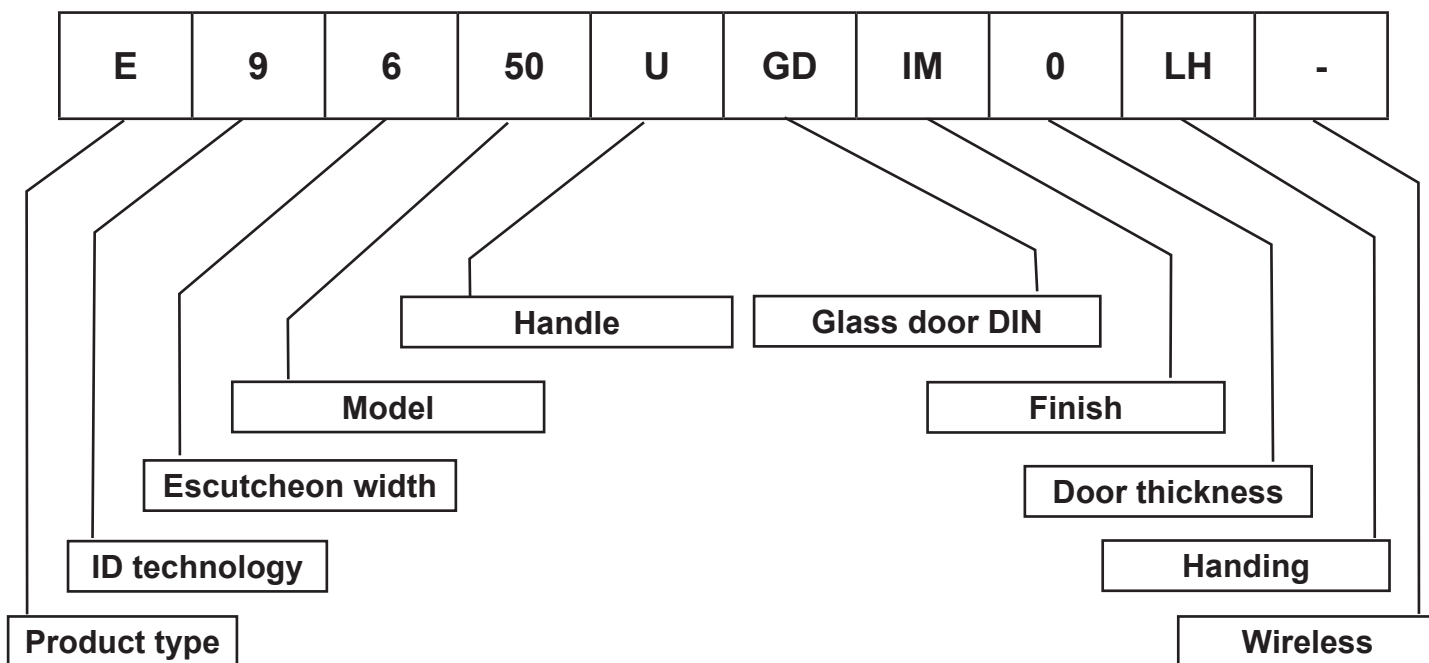
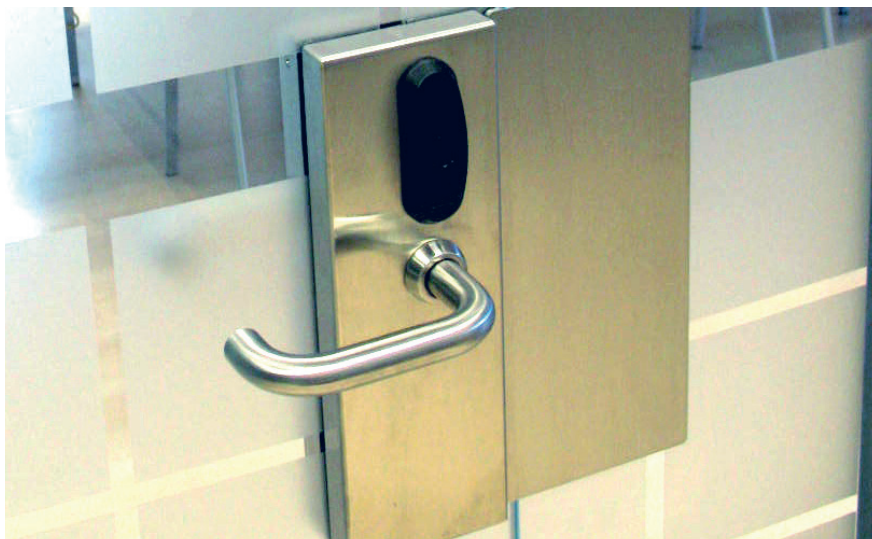

Product type:

E = Escutcheon

ID technology

RFID

- 7 = Contactless Inside Picopass
- 8 = Contactless LEGIC advant
- 9 = Contactless Mifare/DESFire
- H = Contactless iCLASS HID
- B = Contactless BLE Mifare DESFire
- J = Contactless HID iCLASS

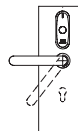

Function

- 50 = Standard escutcheons
- 54 = mechanical cylinder cut out
- P0 = standard escutcheon with mechanical cylinder override

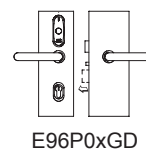
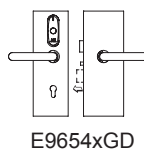
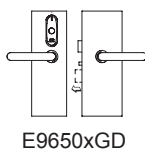

Door Thickness	b Measure
8mm	45
10mm	50
12mm	50

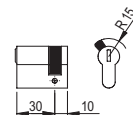

Handles

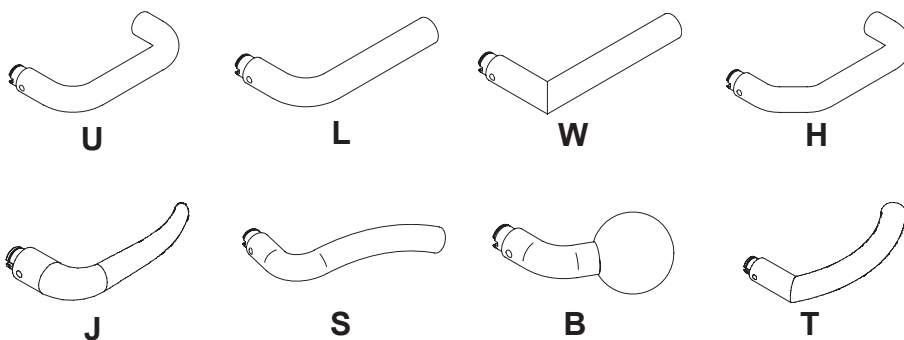

Finishes

IM = Satin stainless steel



Satin Stainless steel finish

Door thickness

0 = 8 - 14mm

Handing

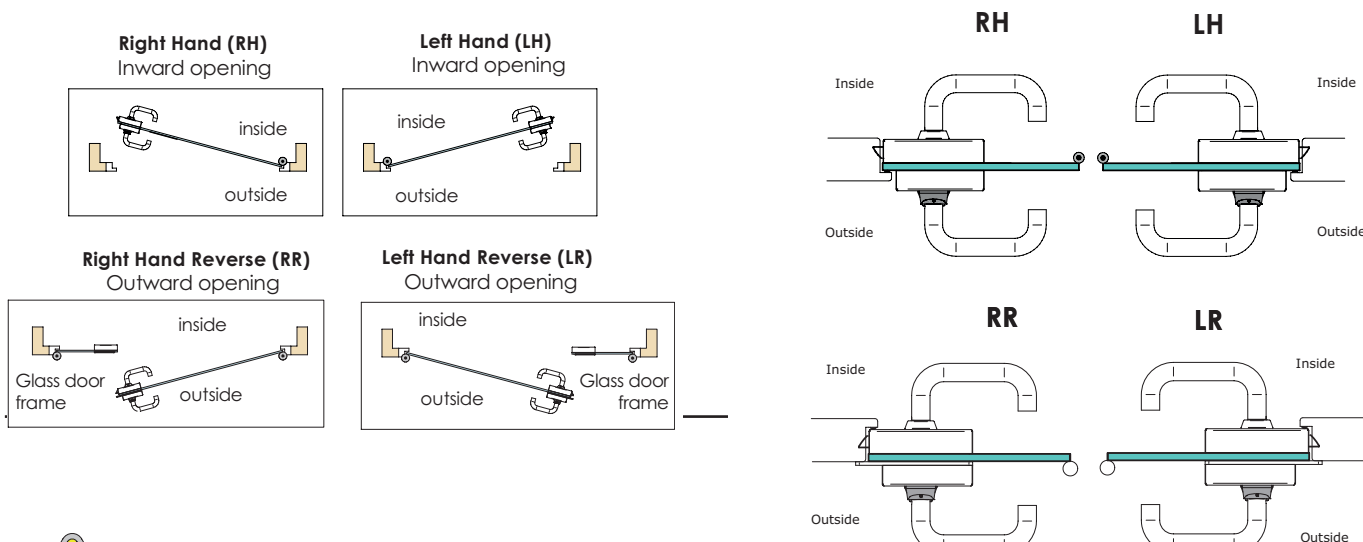

Reverse Models (RR) (LR), only compatible for glass frames

**Notch dimensions
DIN18101**

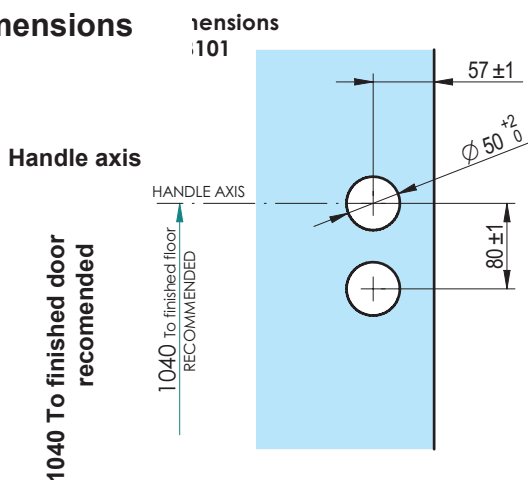

Model Ex650xGD

Electronic Escutcheon, Glass door DIN 18101, 2 handles any type. Includes automatic deadbolt projection mortise lock and strike plate for framed doors.

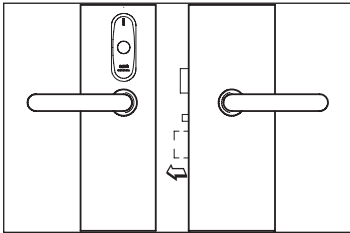

Prices - Gross prices

€



Picopass: Standard - standard square spindles, finishes and handles.

844,50

Picopass: Wireless convertible - standard square spindles, finishes and handles.

888,80

Picopass: Wireless - standard square spindles, finishes and handles.

968,85



Legic advant: Standard - standard square spindles, finishes and handles.

804,20

Legic advant: Wireless convertible - standard square spindles, finishes and handles.

846,45

Legic advant: Wireless - standard square spindles, finishes and handles.

922,65



Mifare - DESFire: Standard - standard square spindles, finishes and handles.

804,20

Mifare - DESFire: Wireless convertible - standard square spindles, finishes and handles.

846,45

Mifare - DESFire: Wireless - standard square spindles, finishes and handles.

922,65



BLE Mifare DESFire: additional price to add to the Mifare DESFire price. **Gross price**

27,70



HID iCLASS: Standard - standard square spindles, finishes and handles.

911,75

HID iCLASS: Wireless convertible - standard square spindles, finishes and handles.

959,65

HID iCLASS: Wireless - standard square spindles, finishes and handles.

1045,95



BLE HID iCLASS: additional price to add to the HID iCLASS price. **Gross price**

27,70

¹ For Handed lever handles, only for S or K handles.

² This option has an additional price please refer to the handles or finishes chapter.

Gain durability feature included by default.

Escutcheon	Technology	Escutcheon width	Model	Handles	Lock position	Finish	Door thickness	Handing	Wireless			
E	7 Picopass	6	50	U	GD DIN 18101	IM	0 8-14mm	LH	C Convertible			
	8 Legic			L				-				
	9 Mifare DESFire			W				RH				
	B BLE Mifare			H ²				GD DIN 18101	IM	0 8-14mm	LR	C Convertible
	H HID iCLASS			S ^{1,2}							RR	
	J BLE HID iCLASS			B ²							W Wireless	
				J								
	T											

Model Ex654xGD

Electronic Escutcheon, Glass door DIN 18101, 2 handles any type. Includes automatic deadbolt projection mortise lock and strike plate for framed doors. With mechanical cylinder cut out (cylinder not included).

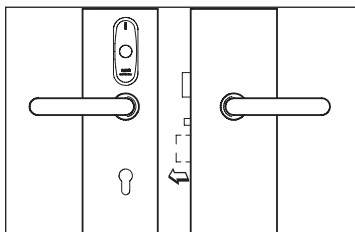

Prices - Gross prices		€
------------------------------	--	---



Picopass: Standard - standard square spindles, finishes and handles.	862,15
Picopass: Wireless convertible - standard square spindles, finishes and handles.	906,60
Picopass: Wireless - standard square spindles, finishes and handles.	986,60



Legic advant: Standard - standard square spindles, finishes and handles.	821,20
Legic advant: Wireless convertible - standard square spindles, finishes and handles.	863,60
Legic advant: Wireless - standard square spindles, finishes and handles.	939,70

MIFARE DESFire

Mifare - DESFire: Standard - standard square spindles, finishes and handles.	821,20
Mifare - DESFire: Wireless convertible - standard square spindles, finishes and handles.	863,60
Mifare - DESFire: Wireless - standard square spindles, finishes and handles.	939,70



BLE Mifare DESFire: additional price to add to the Mifare DESFire price. Gross price	27,70
---	-------



HID iCLASS: Standard - standard square spindles, finishes and handles.	931,00
HID iCLASS: Wireless convertible - standard square spindles, finishes and handles.	978,85
HID iCLASS: Wireless - standard square spindles, finishes and handles.	1065,30



BLE HID iCLASS: additional price to add to the HID iCLASS price. Gross price	27,70
---	-------

¹ For Handed lever handles, only for S or K handles.

² This option has an additional price please refer to the handles or finishes chapter.

Gain durability feature included by default.



Door Thickness	b Measure
8mm	45
10mm	50
12mm	50

Escutcheon	Technology	Escutcheon width	Model	Handles	Lock position	Finish	Door thickness	Handing	Wireless
E	7 Picopass	6	54	U	GD DIN 18101	IM	0 8-14mm	LH	C Convertible
				L					
	8 Legic			W					
				H ²					
	9 Mifare DESFire			S ^{1,2}					
				B ²					
	B BLE Mifare			J				RR Just for glass to glass doors	W Wireless
				H HID iCLASS					
	J BLE HID iCLASS			T					

Model Ex6P0xGD

EleElectronic Escutcheon, Glass door DIN 18101, 2 handles any type. Includes automatic deadbolt projection mortise lock and strike plate for framed doors. With mechanical key override with audit (cylinder not included).

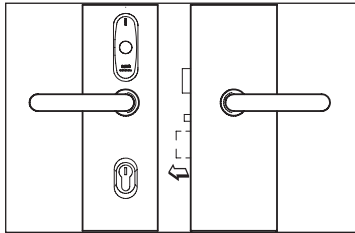

Prices - Gross prices €



Picopass: Standard - standard square spindles, finishes and handles.	
Picopass: Wireless convertible - standard square spindles, finishes and handles.	
Picopass: Wireless - standard square spindles, finishes and handles.	



Legic advant: Standard - standard square spindles, finishes and handles.	
Legic advant: Wireless convertible - standard square spindles, finishes and handles.	
Legic advant: Wireless - standard square spindles, finishes and handles.	



Mifare - DESFire: Standard - standard square spindles, finishes and handles.	
Mifare - DESFire: Wireless convertible - standard square spindles, finishes and handles.	
Mifare - DESFire: Wireless - standard square spindles, finishes and handles.	



BLE Mifare DESFire: additional price to add to the Mifare DESFire price. Gross price	27,70
--	--------------



HID iCLASS: Standard - standard square spindles, finishes and handles.	
HID iCLASS: Wireless convertible - standard square spindles, finishes and handles.	
HID iCLASS: Wireless - standard square spindles, finishes and handles.	



BLE HID iCLASS: additional price to add to the HID iCLASS price. Gross price	27,70
--	--------------

¹ For Handed lever handles, only for S or K handles.

² This option has an additional price please refer to the handles or finishes chapter.

Gain durability feature included by default.

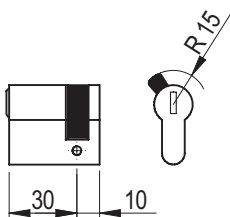

Escutcheon	Technology	Escutcheon width	Model	Handles	Lock position	Finish	Door thickness	Handing	Wireless	
E	7 Picopass	6	P0	U	GD DIN 18101	IM	0 8-14mm	LH	-	
	8 Legic			L						
	9 Mifare DESFire			W						
	B BLE Mifare			H ²					RH	C
	H HID iCLASS			S ^{1,2}					LR	Convertible
	J BLE HID iCLASS			B ²						
				J					RR	W
	T		Just for glass to glass doors	Wireless						

Model E0600xGD

Complementary Escutcheon, Glass door DIN 18101, 2 handles any type. (Mortise lock included).

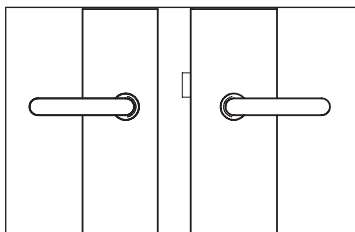

Prices - Gross prices	€
Standard - standard square spindles, finishes and handles.	585,10

¹ For Handed lever handles, only for S or K handles.

² This option has an additional price please refer to the handles or finishes chapter.

Escutcheon	Technology	Escutcheon width	Model	Handles	Lock position	Finish	Door thickness	Handing
E	0	6	00	U	GD DIN 18101	IM	0 8-14mm	LH
				L				
				W				RH
				H ²				
				S ^{1,2}				
				B ²				LR
				J				
T	RR Just for glass to glass doors							

Model E0602xGD

Complementary Escutcheon, Glass door DIN 18101, 2 handles any type. With mechanical cylinder cut out (cylinder not included). (Mortise lock included).

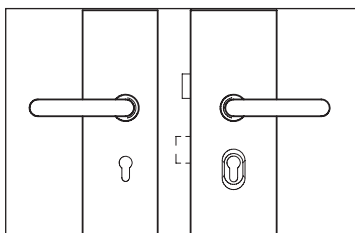

Prices - Gross prices	€
Standard - standard square spindles, finishes and handles.	585,10

¹ For Handed lever handles, only for S or K handles.

² This option has an additional price please refer to the handles or finishes chapter.

Door Thickness	b (Out)	
	Normal LH/RH	Reverse LR/RR
8mm	45	50
10mm	50	50
12mm	50	55
14mm	50	55

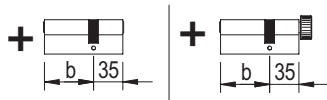

Escutcheon	Technology	Escutcheon width	Model	Handles	Lock position	Finish	Door thickness	Handing
E	0	6	02	U	GD DIN 18101	IM	0 8-14mm	LH
				L				
				W				RH
				H ²				
				S ^{1,2}				
				B ²				LR
				J				
T	RR Just for glass to glass doors							

Model E0603xGD

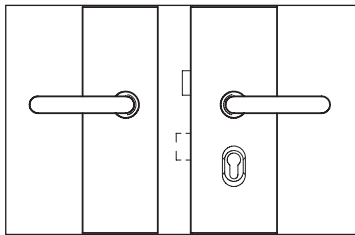

Complementary Escutcheon, Glass door DIN 18101, 2 handles any type. With Inside mechanical cylinder cut out (cylinder not included). (Mortise lock included).

Prices - Gross prices	€
Standard - standard square spindles, finishes and handles.	585,10

¹ For Handed lever handles, only for S or K handles.

² This option has an additional price please refer to the handles or finishes chapter.



Escutcheon	Technology	Escutcheon width	Model	Handles	Lock position	Finish	Door thickness	Handing
E	0	6	03	U	GD DIN 18101	IM	0 8-14mm	LH
				L				
				W				RH
				H ²				
				S ^{1,2}				
				B ²				LR
				J				
T	RR Just for glass to glass doors							

Model E0604xGD

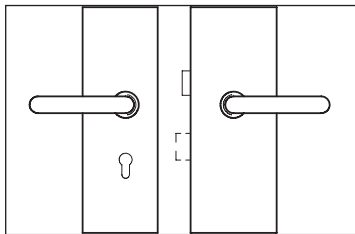

Complementary Escutcheon, Glass door DIN 18101, 2 handles any type. With outside mechanical cylinder cut out (cylinder not included). (Mortise lock included).

Prices - Gross prices	€
Standard - standard square spindles, finishes and handles.	585,10

¹ For Handed lever handles, only for S or K handles.

² This option has an additional price please refer to the handles or finishes chapter.

Door Thickness	b (Out)	
	Normal	Reverse
	LH/RH	LR/RR
8mm	45	50
10mm	50	50
12mm	50	55
14mm	50	55

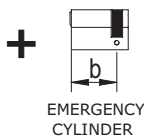

Escutcheon	Technology	Escutcheon width	Model	Handles	Lock position	Finish	Door thickness	Handing
E	0	6	04	U	GD DIN 18101	IM	0 8-14mm	LH
				L				
				W				RH
				H ²				
				S ^{1,2}				
				B ²				LR
				J				
T	RR Just for glass to glass doors							

Model E0609xGD

Complementary Escutcheon, Glass door DIN 18101, one handles any type and one knob. With mechanical cylinder cut out (cylinder not included). (Automatic deadbolt through mortise lock included).

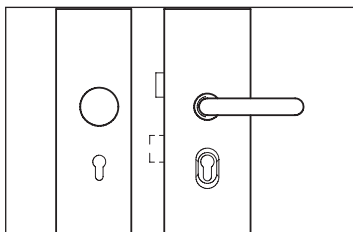

Prices - Gross prices	€
Standard - standard square spindles, finishes and handles.	669,75

¹ For Handed lever handles, only for S or K handles.

² This option has an additional price please refer to the handles or finishes chapter.

Door Thickness	b (Out)	
	Normal	Reverse
	LH/RH	LR/RR
8mm	45	50
10mm	50	50
12mm	50	55
14mm	50	55

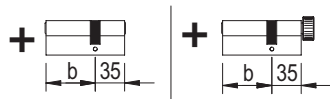

Escutcheon	Technology	Escutcheon width	Model	Handles	Lock position	Finish	Door thickness	Handing
E	0	6	09	U	GD DIN 18101	IM	0 8-14mm	LH
				L				
				W				RH
				H ²				
				S ^{1,2}				
				B ²				LR
				J				
T								
								RR Just for glass to glass doors

Glass door lock model DIN counter strike





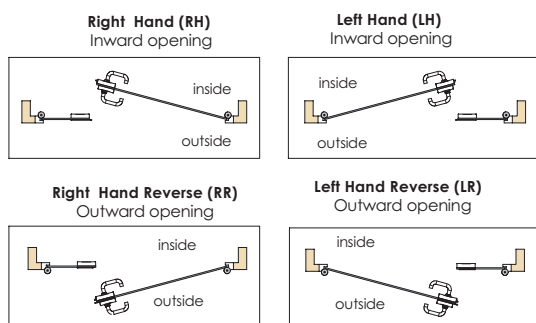



Product description	Product reference				€
Strike plate for glass frames and double doors	Strike	Lock	Handing	Finish	
	CE	GD DIN 18101	LH	IM	268,00
			RH		
			LR		
			RR		

Glass door DIN 18101 strike plate handing

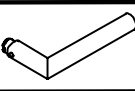

Only those handles regarded as off-set handles have an add-on to the price of the standard escutcheon. 2 remarks:

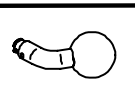
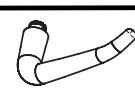
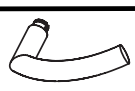
- Prices are gross and per handle, so an E9650 model, for instance, needs 2 handles in the case of an off-set model.
- Prices refer to the IM finish, so please refer to the finishes pricelist in order to establish final price of the product.

FINISH MODEL		SATIN STAINLESS STEEL	Spindle available			Gross price €
			DUAL 8-7Diamond 	8 	9 	
	U	↘		↘		0,00
	L	↘		↘		0,00
	W	↘		↘		0,00
	H	↘		↘		30,15
 L	S	↘		↘		30,15
 R						
	B	↘		↘		71,05
	J	↘		↘		0,00
	T	↘		↘		0,00

Finish Additional Prices - Gross prices

Stainless steel finishes

Satin stainless steel		E X X X X X X I M X X	0,00
-----------------------	---	-----------------------	------



SALTO escutcheon reference example

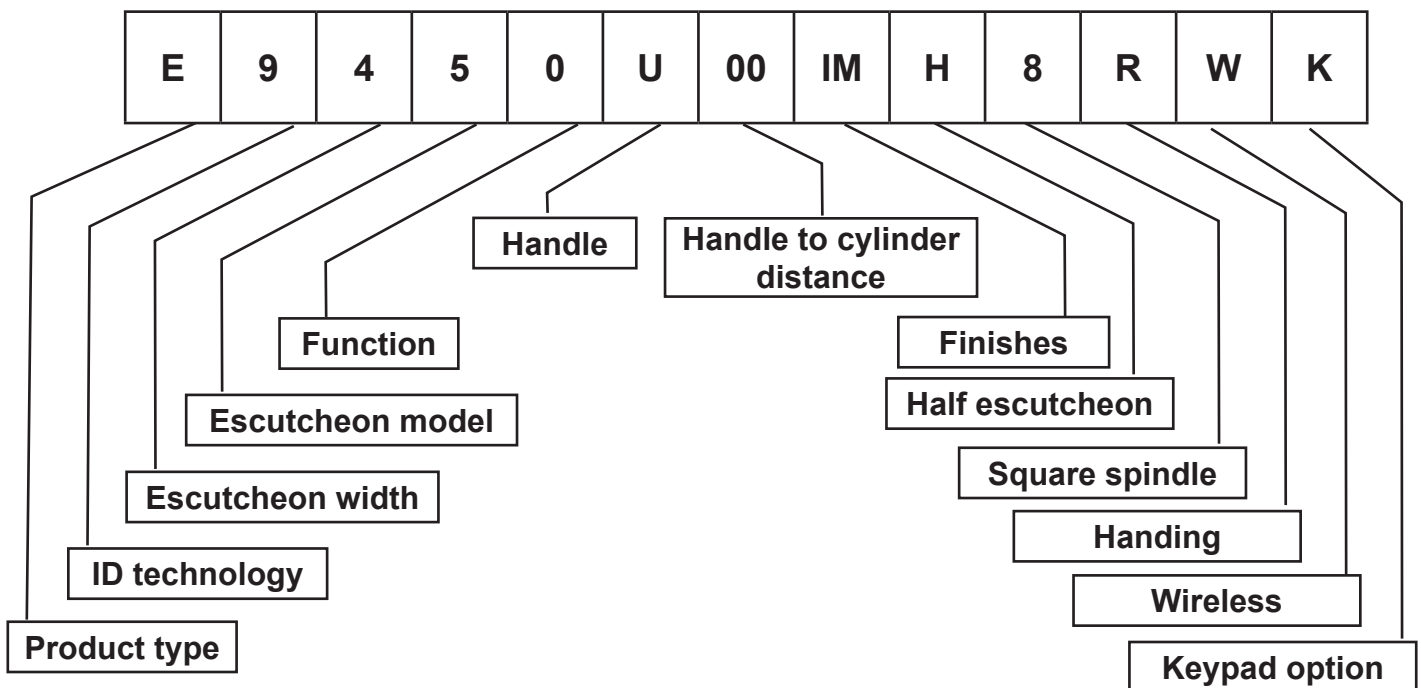

Product type:

E = European escutcheons compatible with European mortise locks.
 A = ANSI escutcheons compatible with ANSI mortise locks.
 S = Scandinavian escutcheons compatible with Scandinavian mortise locks.



ID technology

RFID
 7 = Contactless Inside Picopass
 8 = Contactless LEGIC advant
 9 = Contactless Mifare/DESFire
 H = Contactless iCLASS HID
 B = Contactless BLE Mifare DESFire

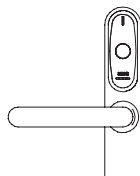

Escutcheon model:

5 = Clutch
 6 = Clutch + override
 P = Clutch + Euro profile cilinder override

(6) Clutch + mechanical override 6 means: mortise cylinder 1-1/8" for ANSI and wide body european escutcheons.

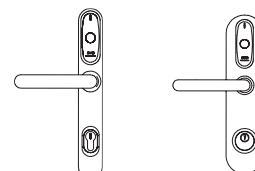

Escutcheon model:

5 = Clutch
6 = Clutch + override
P = Clutch + Euro profile cylinder override

Clutch + mechanical override P means: Euro profile cylinder mechanical override for Euro-pean narrow or wide body escutcheons.

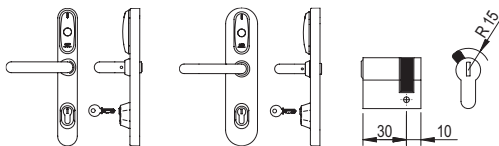

Handles

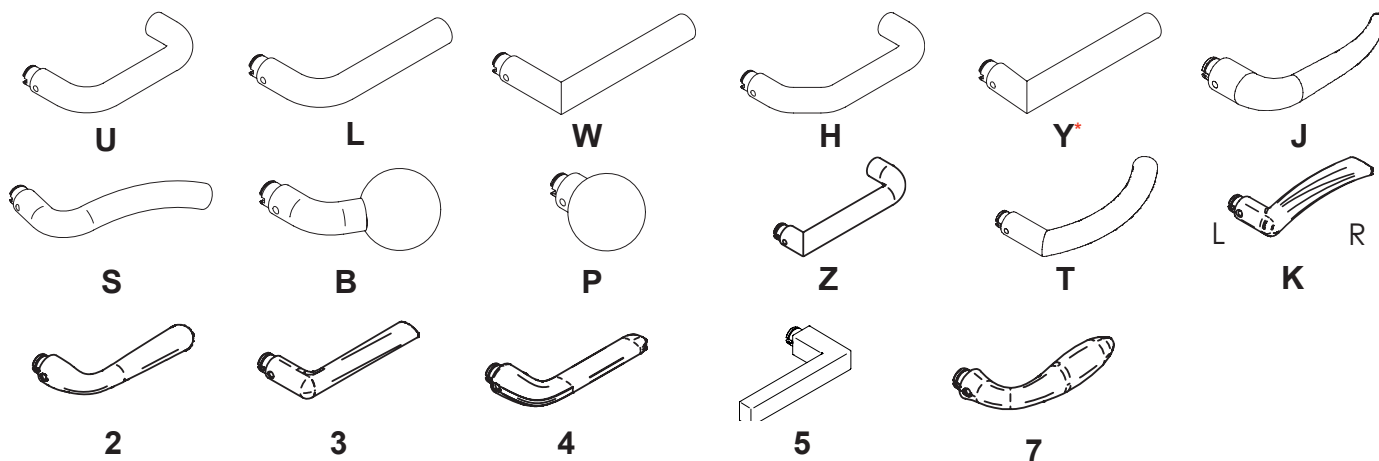

Distance to cylinder

00 = without distance
05 = 105mm scandinavian profile cylinder.
72 = 72mm euro profile cylinder.

7F = 72mm for fire doors
92 = 92mm euro profile cylinder



Fire doors mortise locks

Finishes

IM = Satin stainless steel
IP = Bright stainless steel



Satin stainless steel



Bright stainless steel

Door thickness

H = Half escutcheon for panic device kits
D = Half escutcheon for panic device kits with 3 fixing points for XS4 One escutcheons.

Handle handing

R = Right hand.
L = Left hand.
just for O and S handles

R	RIGHT HAND
L	LEFT HAND

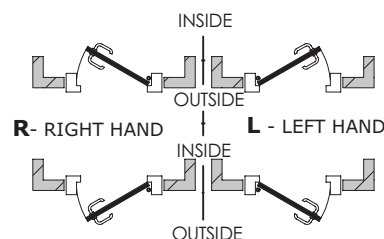

The XS4 Panic bar solution consists of 2, 3 or 4 parts depending on whether or not a mortise lock built in.

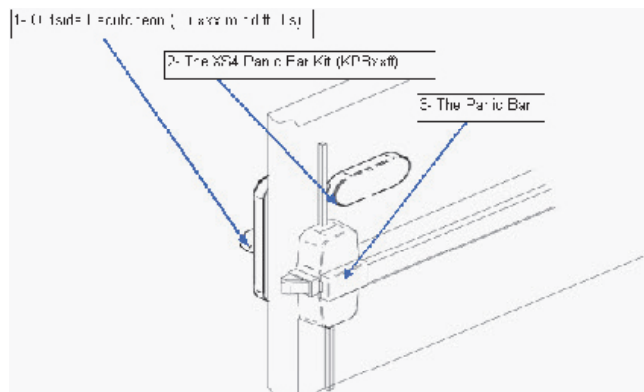
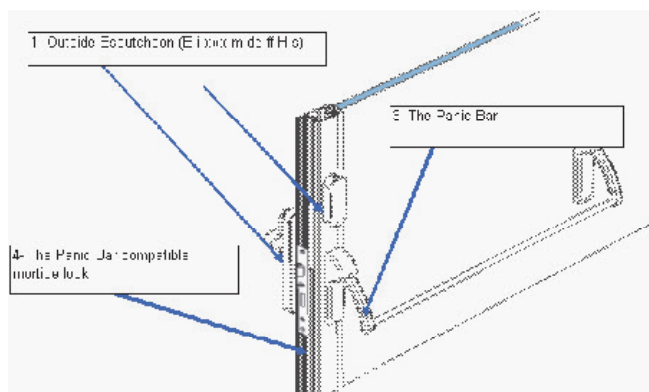

Kit Panic Bars

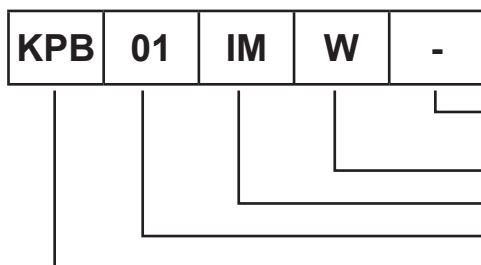

AMOK Technology: 7 (Picopass), 8 (LEGIC Advant), 9 (Mifare DESFire), H (HID iCLASS), B (BLE Mifare DESFire).
Wireless: - (offline stand alone) **W** (wireless online) **A** (AMOK).
Finish: **IM** (Satin stainless steel) **IP** (Bright stainless steel).
Panic bar kit number.
KIT Panic Bar.

Panic bar compatibility

SALTO Systems is compatible with the panic bars detailed below

ANTIPANIC 601 (Single point)
 ASSA 810701
 BKS B7100 61
 BKS B7150
 BKS B7172 51
 BKS B7100 51
 CAL ROYAL 9800 (Single point)
 CISA 59000 (Single point)
 CISA 59010-15 (Multi point)
 CISA 59616
 CISA 59710
 CISA 59800 (Single point)
 CISA 59810-15 (Multi point)
 CORBIN RUSSWIN ED5200 (Single point)
 DORMA 9300 (Single point)
 DORMA AD4300 (Single point)
 DORMA AD4400 (Two locking points)
 DORMA PHA2100 (Single point)
 ECO EPN 900
 ECO EPN 2000

FAPIM PANAMA 8010 (Single point)
 FALCON MONARCH 18 (Single point)
 ISEO IDEA BAR 941 1 (Single point)
 ISEO PUSH BAR 944 1 (Single point)
 NINZ SLASH
 SARGENT 8800 (Single point)
 SÖDERHAMN INNOVATION NÖDÖPPNARE type T
 TESA 1910 (Single point)
 TESA 1920-30-50-5L (Multi point)
 TESA 1970
 TESA TEMPRO TM1
 TINKO 5000 (Single point)
 TINKO 5500 (Mortice Lock)
 VACHETTE 6710 (Single point)
 VACHETTE 6720-30-40-50 (Multi point)
 VON DUPRIN 98 / 99 (Single point)
 VON DUPRIN 98 / 9957 / 9827 (Multi point)
 VON DUPRIN 98 / 9947 (Multi point)
 YALE 7100 (Single point)



For more information about the panic bar - escutcheon - KPB compatibilities please check the KPB chapter.
 Not all the combinations are possible. Only the combination of Electronic escutcheon, KPB, Mortise lock and panic bar detailed by SALTO will warrantee correct use.

Model Ex450xH

SALTO XS4 Electronic Half Escutcheon Ex450 for panic bar, 1 handle, any type.

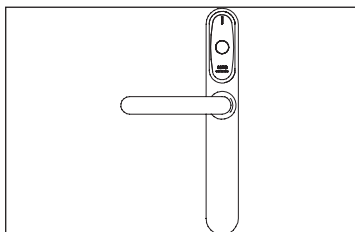

Prices - Gross prices	€
Picopass: Standard - standard square spindles, finishes and handles.	341,55
Picopass: Wireless - standard square spindles, finishes and handles.	377,55
Picopass: AMOK - standard square spindles, finishes and handles.	377,55
Legic Advant: Standard - standard square spindles, finishes and handles.	325,30
Legic Advant: Wireless - standard square spindles, finishes and handles.	361,30
Legic Advant: AMOK - standard square spindles, finishes and handles.	361,30
Mifare - DESFire: Standard - standard square spindles, finishes and handles.	325,30
Mifare - DESFire: Wireless - standard square spindles, finishes and handles.	361,30
Mifare - DESFire: AMOK - standard square spindles, finishes and handles.	361,30
BLE Mifare DESFire: additional price to add to the Mifare DESFire price. Gross price	27,70
HID iCLASS: Standard - standard square spindles, finishes and handles.	410,30
HID iCLASS: Wireless - standard square spindles, finishes and handles.	446,25
HID iCLASS: AMOK - standard square spindles, finishes and handles.	607,10
BLE HID iCLASS: additional price to add to the HID iCLASS price. Gross price	27,70

¹ For Handed lever handles, only for S or K handles.

² This option has an additional price please refer to the handles or finishes chapter.

Gain durability feature included by default.

Technology	Escutcheon width	Function	Handle	Handle to thumbturn	Finish	Door thickness	Square spindle	Handing	Wireless										
E7 PICOPASS	4	50	U	00 without distance	IM	H	7 7mm	-	- offline standa- lone										
			L					-											
			W					-											
H ²			-																
Y ²			-																
S ^{1,2}			R/L ¹	W wireless online															
B ²			-																
P ²			-																
J			-																
T			-																
EB MIFARE BLE	4	50	Z	7F 72mm for fire doors	IP ²	H	8 8mm	-	-										
			K ¹					R/L ¹		A Amok									
EH HID iCLASS			4					50			2 ²	7F 72mm for fire doors	IP ²	H	9 9mm	-	-		
											3 ²					-			
											4 ²					-			
EJ BLE HID iCLASS				4	50		5 ²		7F 72mm for fire doors		IP ²					H		9 9mm	-
							7 ²			-									

Model Ex454xH

SALTO XS4 Electronic Half Escutcheon E9454 for panic bar, 1 handle, any type, outside cylinder cut out.

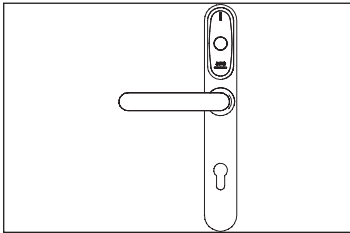

Prices - Gross prices		€
	Picopass: Standard - standard square spindles, finishes and handles.	339,80
	Picopass: Wireless - standard square spindles, finishes and handles.	376,40
	Picopass: AMOK - standard square spindles, finishes and handles.	376,40
	Legic Advant: Standard - standard square spindles, finishes and handles.	328,55
	Legic Advant: Wireless - standard square spindles, finishes and handles.	364,60
	Legic Advant: AMOK - standard square spindles, finishes and handles.	364,60
	Mifare - DESFire: Standard - standard square spindles, finishes and handles.	328,55
	Mifare - DESFire: Wireless - standard square spindles, finishes and handles.	364,60
	Mifare - DESFire: AMOK - standard square spindles, finishes and handles.	364,60
	BLE Mifare DESFire: additional price to add to the Mifare DESFire price. Gross price	27,70
	HID iCLASS: Standard - standard square spindles, finishes and handles.	415,20
	HID iCLASS: Wireless - standard square spindles, finishes and handles.	451,10
	HID iCLASS: AMOK - standard square spindles, finishes and handles.	614,45
	BLE HID iCLASS: additional price to add to the HID iCLASS price. Gross price	27,70

¹ For Handed lever handles, only for S or K handles.

² This option has an additional price please refer to the handles or finishes chapter.

Gain durability feature included by default.

Technology	Escutcheon width	Function	Handle	Handle to thumbturn	Finish	Door thickness	Square spindle	Handing	Wireless
E7 PICOPASS	4	54	U	72	IM	H	7 7mm	-	- offline standa- lone
			L					-	
			W					-	
E8 LEGIC			H ²					-	
			Y ²					-	
			S ^{1,2}					R/L ¹	
E9 MIFARE			7F	B ²	-		W wireless online		
				P ²	-				
				J	-				
EB MIFARE BLE			72mm for fire doors	T	-				
				Z	-				
				K ¹	-				
EH HID iCLASS	92	IP ²	2 ²	-	R/L ¹	A Amok			
			3 ²	-					
			4 ²	-					
EJ BLE HID iCLASS			5 ²	-					
			7 ²	-					
				-					

Model Ex4P0xH

SALTO XS4 Electronic Half Escutcheon Ex4P0 for panic bar, 1 handle, any type, built in mechanical cylinder with audit.
(mechanical cylinder not included, for technical specifications consult SALTO).

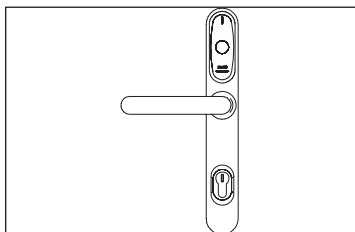

Prices - Gross prices	€
Picopass: Standard - standard square spindles, finishes and handles.	346,75
Picopass: Wireless - standard square spindles, finishes and handles.	382,65
Picopass: AMOK - standard square spindles, finishes and handles.	382,65
Legic Advant: Standard - standard square spindles, finishes and handles.	330,40
Legic Advant: Wireless - standard square spindles, finishes and handles.	366,45
Legic Advant: AMOK - standard square spindles, finishes and handles.	366,45
Mifare - DESFire: Standard - standard square spindles, finishes and handles.	330,40
Mifare - DESFire: Wireless - standard square spindles, finishes and handles.	366,45
Mifare - DESFire: AMOK - standard square spindles, finishes and handles.	419,40
BLE Mifare DESFire: additional price to add to the Mifare DESFire price. Gross price	27,70
HID iCLASS: Standard - standard square spindles, finishes and handles.	418,30
HID iCLASS: Wireless - standard square spindles, finishes and handles.	454,35
HID iCLASS: AMOK - standard square spindles, finishes and handles.	619,05
BLE HID iCLASS: additional price to add to the HID iCLASS price. Gross price	27,70

¹ For Handed lever handles, only for S or K handles.

² This option has an additional price please refer to the handles or finishes chapter.





Gain durability feature included by default.

Technology	Escutcheon width	Function	Handle	Handle to thumbturn	Finish	Door thickness	Square spindle	Handing	Wireless				
E7 PICOPASS	4	P0 Euro profile cylinder 30-10	U	00 without distance	IM	H	7 7mm	-	- offline stand-alone				
			L					-					
			W					-					
E8 LEGIC			H ²				Y ²	IP ²	H	8 8mm	R/L ¹	W wireless online	
							B ²				-		
							P ²				-		
E9 MIFARE			J				K ¹	IP ²	H	9 9mm	R/L ¹	A Amok	
											T		-
											Z		-
EB MIFARE BLE			2 ²				3 ²	IP ²	H	9 9mm	-	-	
	4 ²	-											
	5 ²	-											
EH HID iCLASS	7 ²	-	IP ²	H	9 9mm	-	-						
						7 ²		-					

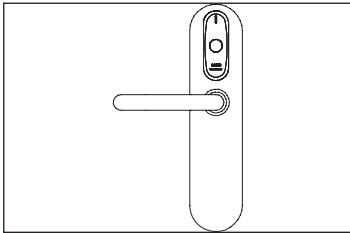
Model Ex650xH

SALTO XS4 Electronic Half Escutcheon Ex650 for panic bar, 1 handle, any type.



Prices - Gross prices		€
	Picopass: Standard - standard square spindles, finishes and handles.	363,05
	Picopass: Wireless - standard square spindles, finishes and handles.	399,00
	Picopass: AMOK - standard square spindles, finishes and handles.	399,00
	Legic Advant: Standard - standard square spindles, finishes and handles.	345,80
	Legic Advant: Wireless - standard square spindles, finishes and handles.	381,60
	Legic Advant: AMOK - standard square spindles, finishes and handles.	381,60
MIFARE DESFire	Mifare - DESFire: Standard - standard square spindles, finishes and handles.	345,80
	Mifare - DESFire: Wireless - standard square spindles, finishes and handles.	381,60
	Mifare - DESFire: AMOK - standard square spindles, finishes and handles.	438,95
	BLE Mifare DESFire: additional price to add to the Mifare DESFire price. Gross price	27,70
	HID iCLASS: Standard - standard square spindles, finishes and handles.	430,70
	HID iCLASS: Wireless - standard square spindles, finishes and handles.	466,65
	HID iCLASS: AMOK - standard square spindles, finishes and handles.	637,40
	BLE HID iCLASS: additional price to add to the HID iCLASS price. Gross price	27,70

¹ For Handed lever handles, only for S or K handles.

² This option has an additional price please refer to the handles or finishes chapter.

Gain durability feature included by default.

Technology	Escutcheon width	Function	Handle	Handle to thumbturn	Finish	Door thickness	Square spindle	Handing	Wireless			
E7 PICOPASS	6	50	U	00 without distance	IM	H	7 7mm	-	- offline standa- lone			
			L					-				
			W					-				
H ²			-									
Y ²			-									
S ^{1,2}			R/L ¹									
E8 LEGIC			B ²	-	-		-	-	8 8mm	-	W wireless online	
										Y ²		-
										S ^{1,2}		-
E9 MIFARE			J	-	-		-	-	9 9mm	-	A Amok	
										P ²		-
										Z		-
EB MIFARE BLE	K ¹	-	-	7F 72mm for fire doors	IP ²	9 9mm	R/L ¹	-				
							T		-			
							Z		-			
EH HID iCLASS	2 ²	-	-	-	-	9 9mm	-	-				
							3 ²		-			
							4 ²		-			
EJ BLE HID iCLASS	5 ²	-	-	-	-	9 9mm	-	-				
							7 ²		-			
							-		-			

Model Ex654xH

SALTO XS4 Electronic Half Escutcheon Ex650 for panic bar, 1 handle, any type, outside cylinder cut out.

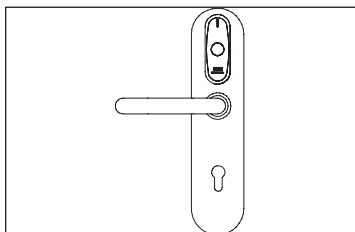

Prices - Gross prices	€
Picopass: Standard - standard square spindles, finishes and handles.	361,80
Picopass: Wireless - standard square spindles, finishes and handles.	397,85
Picopass: AMOK - standard square spindles, finishes and handles.	397,85
Legic Advant: Standard - standard square spindles, finishes and handles.	346,30
Legic Advant: Wireless - standard square spindles, finishes and handles.	384,90
Legic Advant: AMOK - standard square spindles, finishes and handles.	384,90
Mifare - DESFire: Standard - standard square spindles, finishes and handles.	346,30
Mifare - DESFire: Wireless - standard square spindles, finishes and handles.	384,90
Mifare - DESFire: AMOK - standard square spindles, finishes and handles.	439,65
BLE Mifare DESFire: additional price to add to the Mifare DESFire price. Gross price	27,70
HID iCLASS: Standard - standard square spindles, finishes and handles.	432,10
HID iCLASS: Wireless - standard square spindles, finishes and handles.	468,15
HID iCLASS: AMOK - standard square spindles, finishes and handles.	639,40
BLE HID iCLASS: additional price to add to the HID iCLASS price. Gross price	27,70



¹ For Handed lever handles, only for S or K handles.

² This option has an additional price please refer to the handles or finishes chapter.

Gain durability feature included by default.

Technology	Escutcheon width	Function	Handle	Handle to thumbturn	Finish	Door thickness	Square spindle	Handing	Wireless							
E7 PICOPASS	6	54	U	72	IM	H	7 7mm	-	- offline standa- lone							
			L					-								
			W					-								
E8 LEGIC			H ²	Y ²	S ^{1,2}		7F	IP ²	8 8mm	R/L ¹	W wireless online					
										B ²		-				
										P ²		-				
E9 MIFARE			J	T	Z		72mm for fire doors	IP ²	9 9mm	-	A Amok					
EB MIFARE BLE										K ¹		2 ²	3 ²	4 ²	5 ²	7 ²
EH HID iCLASS																
EJ BLE HID iCLASS	-															

Model Ex660xH

SALTO XS4 Electronic Half Escutcheon Ex660 for panic bar, 1 handle, any type, built in mechanical cylinder with audit.
(mechanical cylinder not included, for technical specifications consult SALTO).

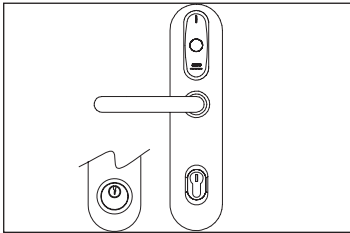

Prices - Gross prices		€
	Picopass: Standard - standard square spindles, finishes and handles.	368,00
	Picopass: Wireless - standard square spindles, finishes and handles.	404,15
	Picopass: AMOK - standard square spindles, finishes and handles.	404,15
	Legic Advant: Standard - standard square spindles, finishes and handles.	350,95
	Legic Advant: Wireless - standard square spindles, finishes and handles.	386,90
	Legic Advant: AMOK - standard square spindles, finishes and handles.	386,90
	Mifare - DESFire: Standard - standard square spindles, finishes and handles.	350,95
	Mifare - DESFire: Wireless - standard square spindles, finishes and handles.	386,90
	Mifare - DESFire: AMOK - standard square spindles, finishes and handles.	445,50
	BLE Mifare DESFire: additional price to add to the Mifare DESFire price. Gross price	27,70
	HID iCLASS: Standard - standard square spindles, finishes and handles.	435,90
	HID iCLASS: Wireless - standard square spindles, finishes and handles.	471,80
	HID iCLASS: AMOK - standard square spindles, finishes and handles.	645,05
	BLE HID iCLASS: additional price to add to the HID iCLASS price. Gross price	27,70

¹ For Handed lever handles, only for S or K handles.

² This option has an additional price please refer to the handles or finishes chapter.

Model Ex6P0 is not possible with distance 7F.

Gain durability feature included by default.

Technology	Escutcheon width	Function	Handle	Handle to thumbturn	Finish	Door thickness	Square spindle	Handing	Wireless	
E7 PICOPASS	6	60 Mortise cylinder 1-1/8	U	00 without distance	IM	H	7 7mm	-	- offline stand-alone	
			L					-		
			W					-		
H ²			-							
Y ²			-							
S ^{1,2}			-							
E8 LEGIC		E9 MIFARE	P0 Euro profile cylinder 30-10	B ²	7F 72mm for fire doors		IP ²	8 8mm	R/L ¹	W wireless online
				P ²					-	
				J					-	
T		-								
Z		-								
K ¹		R/L ¹		A Amok						
2 ²	-									
3 ²	-									
4 ²	-									
EH HID iCLASS	EJ BLE HID iCLASS	P0 Euro profile cylinder 30-10	5 ²	7F 72mm for fire doors	IP ²	9 9mm	-	A Amok		
			6 ²				-			
			7 ²				-			

Model Ex650xHxK

SALTO XS4 Electronic Half Escutcheon Ex650 with keypad for panic bar, 1 handle, any type.

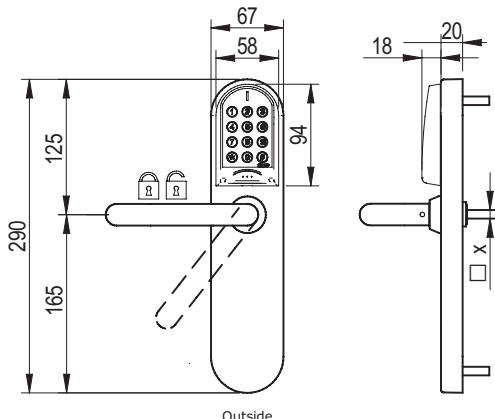
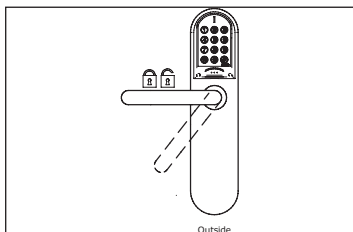

- ¹ For Handed lever handles, only for O, S or K handles.
 - ² This option has an additional price please refer to the handles or finishes chapter.
- Gain durability feature included by default.

This model has to be installed in combination with a wireless KPB even if wireless capabilities are not required

Prices - Gross prices	€
MIFARE DESFire BLE MIFARE - DESFire: Standard - standard square spindles, finishes and handles.	424,20
BLE MIFARE - DESFire: Wireless - standard square spindles, finishes and handles.	467,45
iCLASS BLE HID iCLASS: Standard - standard square spindles, finishes and handles.	519,50
BLE HID iCLASS: Wireless - standard square spindles, finishes and handles.	562,65

Technology	Escutcheon width	Function	Handle	Handle to thumbturn	Finish	Door Thickness	Square spindle	Handing	Wireless	Keypad option							
EB BLE MIFARE DESFire	6	50	U	00 without distance	IM	H	7 7mm	-	-	standlone							
			L														
			W														
			A														
			EJ BLE HID iCLASS				6	50			H ²	7F 72mm for fire doors	IP ²	H	8 8mm	-	W wireless online
											Y ²						
											S ^{1,2}						
											B ²						
EJ BLE HID iCLASS	6	50		P ²	7F 72mm for fire doors	IP ²			H	9 9mm	R / L ¹				W wireless online		
				O ¹													
				J													
				T													
			EJ BLE HID iCLASS	6			50	Z		7F 72mm for fire doors	IP ²	H	9 9mm	-		W wireless online	
								K ¹									
								2 ²									
								3 ²									
EJ BLE HID iCLASS	6	50			4 ²	7F 72mm for fire doors		IP ²	H				9 9mm	-	W wireless online		
					5 ²												
					7 ²												
					-												

Model Ex654xHxK

SALTO XS4 Electronic Half Escutcheon Ex650 with keypad for panic bar, 1 handle, any type, outside cylinder cut out.

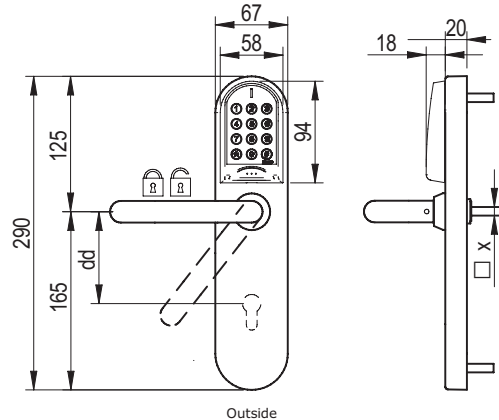
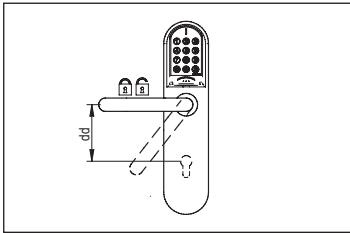

¹ For Handed lever handles, only for O, S or K handles.

² This option has an additional price please refer to the handles or finishes chapter.

Gain durability feature included by default.

This model has to be installed in combination with a wireless KPB even if wireless capabilities are not required

Prices - Gross prices		€
	BLE MIFARE - DESFire: Standard - standard square spindles, finishes and handles.	442,65
	BLE MIFARE - DESFire: Wireless - standard square spindles, finishes and handles.	485,65
	BLE HID iCLASS: Standard - standard square spindles, finishes and handles.	525,25
	BLE HID iCLASS: Wireless - standard square spindles, finishes and handles.	568,45

Technology	Escutcheon width	Function	Handle	Handle to thumbturn	Finish	Door Thickness	Square spindle	Handing	Wireless	Keypad option			
EB BLE MIFARE DESFire	6	54	U	72	IM	H	7 7mm	-	-	K Key pad option			
			L										
			W										
			A										
			H ²										
			Y ²										
			S ^{1,2}										
EJ BLE HID iCLASS			7F	IP ²	B ²		92	IP ²	8 8mm		R / L ¹	-	W wireless online
					P ²								
					O ¹								
					J								
					T								
					Z								
					K ¹								
	92	IP ²	2 ²	92	IP ²	9 9mm	R / L ¹	-	W wireless online				
			3 ²										
			4 ²										
			5 ²										
			7 ²										

Model ExP0xHxK

SALTO XS4 Electronic Half Escutcheon Ex660 with keypad for panic bar, 1 handle, any type, built in mechanical cylinder with audit, (mechanical cylinder not included, for technical specifications consult SALTO).

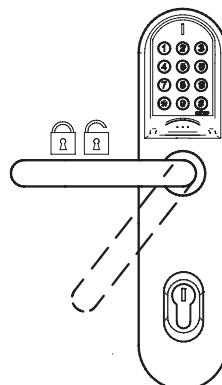
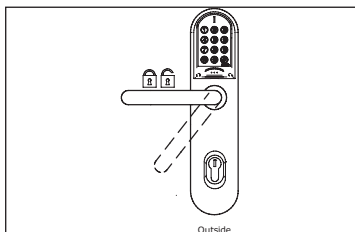

¹ For Handed lever handles, only for O, S or K handles.

² This option has an additional price please refer to the handles or finishes chapter.

Gain durability feature included by default.

This model has to be installed in combination with a wireless KPB even if wireless capabilities are not required

Prices - Gross prices	€
MIFARE DESFire BLE MIFARE - DESFire: Standard - standard square spindles, finishes and handles.	443,25
BLE MIFARE - DESFire: Wireless - standard square spindles, finishes and handles.	489,55
iCLASS BLE HID iCLASS: Standard - standard square spindles, finishes and handles.	529,20
BLE HID iCLASS: Wireless - standard square spindles, finishes and handles.	572,30

Technology	Escutcheon width	Function	Handle	Handle to thumbturn	Finish	Door Thickness	Square spindle	Handing	Wireless	Keypad option	
EB BLE MIFARE DESFire	6	60 Mortise cylinder 1-1/8"	U	00 without distance	IM	H	7 7mm	-	-	K Key pad option	
			L								
			W								
			A								
			H ²								
			Y ²								
			S ^{1,2}								
			B ²								
P ²											
O ¹											
EJ BLE HID iCLASS		P0 Euro profile cylinder 30-10	7F 72mm for fire doors	J	IP ²		9 9mm	-	-		W wireless online
				T							
				Z							
				K ¹							
	2 ²										
	3 ²										
4 ²											
5 ²											
7 ²											

Model Ex6P0 is not possible with distance 7F.

Model Ex750xD

SALTO XS4 One Electronic Half Escutcheon Ex750 for panic bar, 1 handle, any type.

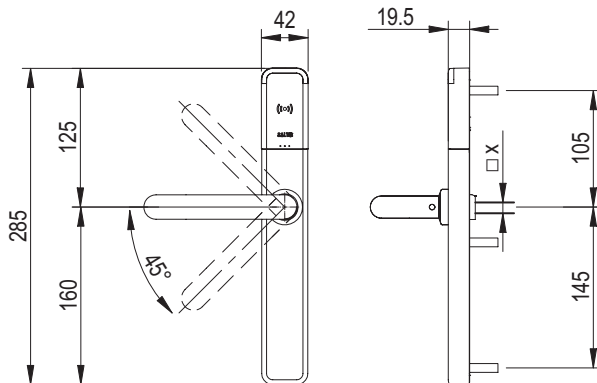
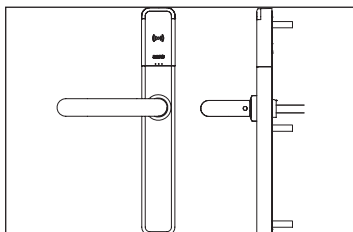

	Prices - Gross prices	€
	BLE Mifare DESFire: Standard - standard square spindles, finishes and handles.	362,70
	Mifare DESFire: Standard - standard square spindles, finishes and handles.	334,20
	BLE HID iCLASS: Standard - standard square spindles, finishes and handles.	464,25



¹ For Handed lever handles, only for S and K handle.

^{2,3} This option has an additional price, please refer to the handles or finishes chapter.

³ Water resistance additional price

Ref	Remarks	€
5	Water resistant (IP55)	21,30

Technology	Escutchon width	Function	Handle	Handle to thumbturn	Finish	Reader finish	Door thickness	Square spindle	Handing	Water resistance										
E9 MIFARE	7	50	U	00	IM	B Black	D Check KPB compatibility	8 8mm	-	- IP53										
			L						-											
			W						-											
			Y ²						-											
			H ²						-											
			S ^{1,2}						-											
EB BLE MIFARE DESfire			7	50	B ²	00	IM	B Black	D Check KPB compatibility	8 8mm	R/L ¹	- IP53								
					P ²						-									
					J						-									
EJ HID iCLASS DESfire					7						50		T	7F 72mm for fire doors	IP ²	W White	H Check KPB compatibility	9 9mm	-	5 ³ IP55
													Z						-	
													K ¹						-	
	2 ²	-																		
	3 ²	R/L ¹																		
	4 ²	-																		
5 ²	-																			
7 ²	-																			

Model Ex754xD

SALTO XS4 One Electronic Half Escutcheon Ex750 for panic bar, 1 handle, any type, outside cylinder cut out.

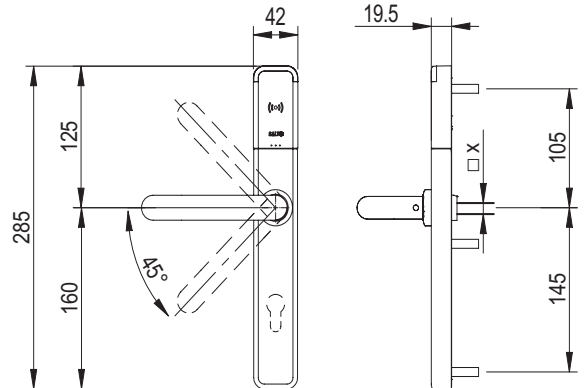
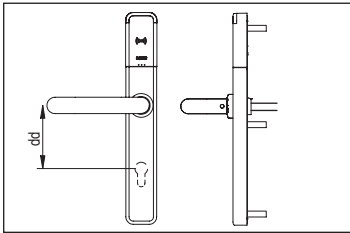

Prices - Gross prices		€
	BLE Mifare DESFire: Standard - standard square spindles, finishes and handles.	366,10
	Mifare DESFire: Standard - standard square spindles, finishes and handles.	337,60
	BLE HID iCLASS: Standard - standard square spindles, finishes and handles.	468,60



¹ For Handed lever handles, only for S and K handle.

^{2,3} This option has an additional price, please refer to the handles or finishes chapter.

³ Water resistance additional price

Ref	Remarks	€
5	Water resistant (IP55)	21,30

Technology	Escutcheon width	Function	Handle	Handle to thumbturn	Finish	Reader finish	Door thickness	Square spindle	Handing	Water resistance														
E9 MIFARE	7	54	U	7F	IM	B Black	D Check KPB compatibility	8 8mm	-	- IP53														
			L																					
			W																					
			Y ²																					
			H ²																					
			S ^{1,2}																					
EB BLE MIFARE DESfire			7	54					B ²		7F	IM	B Black	D Check KPB compatibility	8 8mm	R/L ¹	- IP53							
									P ²															
									J															
									T															
EJ HID iCLASS DESfire									7		54					Z		72mm for fire doors	IP ²	W White	H Check KPB compatibility	9 9mm	-	5 ³ IP55
																K ¹								
	2 ²																							
	3 ²																							
	4 ²																							
	5 ²																							
7 ²																								

Model Ex7P0xD

SALTO XS4 One Electronic Half Escutcheon Ex750 for panic bar, 1 handle, any type, built in mechanical cylinder with audit. (mechanical cylinder not included, for technical specifications consult SALTO).

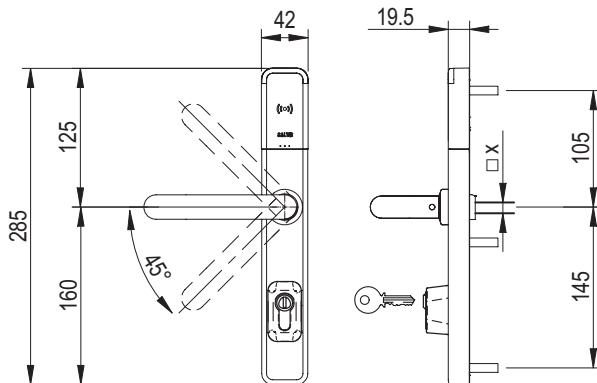
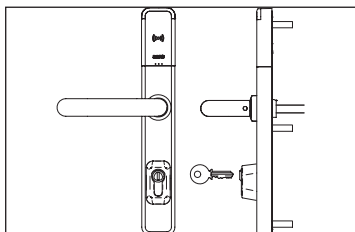

	Prices - Gross prices	€
	BLE Mifare DESFire: Standard - standard square spindles, finishes and handles.	367,90
	Mifare DESFire: Standard - standard square spindles, finishes and handles.	339,45
	BLE HID iCLASS: Standard - standard square spindles, finishes and handles.	470,95

¹ For Handed lever handles, only for S and K handle.

^{2,3} This option has an additional price, please refer to the handles or finishes chapter.

³ **Water resistance additional price**

Ref	Remarks	€
5	Water resistant (IP55)	21,30

Technology	Escutchon width	Function	Handle	Handle to thumbturn	Finish	Reader finish	Door thickness	Square spindle	Handing	Water resistance			
E9 MIFARE	7	P0 Euro profile cylinder 30-10	U	00	IM	B Black	D Check KPB compatibility	8 8mm	-	- IP53			
			L						-				
			W						-				
			Y ²						-				
			H ²						-				
			S ^{1,2}						-				
EB BLE MIFARE DESfire			7		P0 Euro profile cylinder 30-10	B ²	00	IM	B Black	D Check KPB compatibility	8 8mm	R/L ¹	- IP53
						P ²						-	
						J						-	
						T						-	
Z						-							
K ¹						-							
EJ HID iCLASS DESfire	7	P0 Euro profile cylinder 30-10		2 ²		00		IP ²	W White	H Check KPB compatibility	9 9mm	-	5 ³ IP55
				3 ²								R/L ¹	
				4 ²								-	
				5 ²								-	
				7 ²								-	
												-	

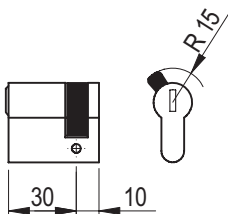

Model Ax650xH

SALTO XS4 Electronic Half Escutcheon Ax650 for panic bar, 1 handle, any type.

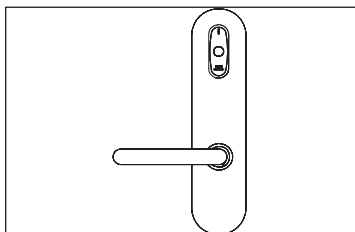

Prices - Gross prices		€
	Picopass: Standard - standard square spindles, finishes and handles.	363,05
	Picopass: Wireless - standard square spindles, finishes and handles.	399,00
	Picopass: AMOK - standard square spindles, finishes and handles.	399,00
	Legic Advant: Standard - standard square spindles, finishes and handles.	345,80
	Legic Advant: Wireless - standard square spindles, finishes and handles.	381,60
	Legic Advant: AMOK - standard square spindles, finishes and handles.	381,60
MIFARE DESFire	Mifare - DESFire: Standard - standard square spindles, finishes and handles.	345,80
	Mifare - DESFire: Wireless - standard square spindles, finishes and handles.	381,60
	Mifare - DESFire: AMOK - standard square spindles, finishes and handles.	433,40
MIFARE DESFire	BLE Mifare DESFire: additional price to add to the Mifare DESFire price. Gross price	27,70
	HID iCLASS: Standard - standard square spindles, finishes and handles.	430,70
	HID iCLASS: Wireless - standard square spindles, finishes and handles.	466,65
	HID iCLASS: AMOK - standard square spindles, finishes and handles.	627,55
	BLE HID iCLASS: additional price to add to the HID iCLASS price. Gross price	27,70

¹ For Handed lever handles, only for S, O or K handles.

² This option has an additional price please refer to the handles or finishes chapter.

³ Half escutcheon model, only compatible for Von Duprin 98 / 9957 concealed vertical rod panic bar.

* UL Listed in combination with SALTO PBF1100 RIM panic bar and SALTO KPB03xxU series. Not available in wireless or iButton.

Gain durability feature included by default.

Technology	Escutchon width	Function	Handle	Handle to thumbturn	Finish	Door thickness	Square spindle	Handing	Certification	Wireless																						
A7 PICOPASS	6	50	U	00	IM	H	8 8mm	-	Standard	-																						
			L																													
			W																													
A																																
H ²																																
Y ²																																
A8 LEGIC			6					50		S ^{1,2}	00	IM	H	8 8mm	R/L ¹	Standard	-															
										B ²																						
										P ²																						
A9 MIFARE										6					50			O ¹	00	IM	H	8 8mm	-	Standard	-							
																		J														
																		T														
AB MIFARE BLE	6	50		Z	00	IP ²	P ³ For concealed rod panic bars		9 9mm								R/L ¹	U					-									
				-																												
				-																												
AH HID iCLASS				6													50								K ¹	00	IP ²	P ³ For concealed rod panic bars	9 9mm	R / L ¹	UL-listed*	-
																									2 ²							
																									3 ²							
AJ BLE HID iCLASS			6					50			4 ²	00	IP ²	P ³ For concealed rod panic bars		9 9mm							-		UL-listed*					-		
											5 ²																					
											7 ²																					

Model Ax660xH

SALTO XS4 Electronic Half Escutcheon Ax660 for panic bar, 1 handle, any type, built in mechanical cylinder with audit.
(mechanical cylinder not included, for technical specifications consult SALTO).

	€
Prices - Gross prices	
Picopass: Standard - standard square spindles, finishes and handles.	368,00
Picopass: Wireless - standard square spindles, finishes and handles.	404,15
Picopass: AMOK - standard square spindles, finishes and handles.	404,15
Legic Advant: Standard - standard square spindles, finishes and handles.	350,95
Legic Advant: Wireless - standard square spindles, finishes and handles.	386,90
Legic Advant: AMOK - standard square spindles, finishes and handles.	386,90
Mifare - DESFire: Standard - standard square spindles, finishes and handles.	350,95
Mifare - DESFire: Wireless - standard square spindles, finishes and handles.	386,90
Mifare - DESFire: AMOK - standard square spindles, finishes and handles.	439,75
BLE Mifare DESFire: additional price to add to the Mifare DESFire price. Gross price	27,70
HID iCLASS: Standard - standard square spindles, finishes and handles.	471,80
HID iCLASS: Wireless - standard square spindles, finishes and handles.	645,05
HID iCLASS: AMOK - standard square spindles, finishes and handles.	430,70
BLE HID iCLASS: additional price to add to the HID iCLASS price. Gross price	27,70

¹ For Handed lever handles, only for S, O or K handles.

² This option has an additional price please refer to the handles or finishes chapter.

³ Half escutcheon model, only compatible for Von Duprin 98 / 9957 concealed vertical rod panic bar.

* UL Listed in combination with SALTO PBF1100 RIM panic bar and SALTO KPB03xxU series. Not available in wireless or iButton.

Gain durability feature included by default.

Technology	Escutchon width	Function	Handle	Handle to thumbturn	Finish	Door thickness	Square spindle	Handing	Certification	Wireless																						
A7 PICOPASS	6	60	U	00	IM	H	8 8mm	-	Standard	-																						
			L																													
			W																													
A																																
H ²																																
Y ²																																
A8 LEGIC			6					60		S ^{1,2}	00	IM	H	8 8mm	R/L ¹	Standard	-															
										B ²																						
										P ²																						
A9 MIFARE										6					60			O ¹	00	IM	H	8 8mm	-	Standard	-							
																		J														
																		T														
AB MIFARE BLE	6	60		Z	00	IP ²	P ³ For concealed rod panic bars		9 9mm								R/L ¹	U					-									
				K ¹																												
				2 ²																												
AH HID iCLASS				6													60								3 ²	00	IP ²	P ³ For concealed rod panic bars	9 9mm	-	U	-
																									4 ²							
																									5 ²							
AJ BLE HID iCLASS			6					60			7 ²	00	IP ²	P ³ For concealed rod panic bars		9 9mm							-		U					-		
											2 ²																					
											3 ²																					
AH HID iCLASS										6	60				4 ²				00	IP ²	P ³ For concealed rod panic bars	9 9mm	-	U								-
															5 ²																	
															7 ²																	
AJ BLE HID iCLASS	6	60			2 ²	00	IP ²		P ³ For concealed rod panic bars						9 9mm			-					U							-		
					3 ²																											
					4 ²																											
AH HID iCLASS				6	60												5 ²	00								IP ²	P ³ For concealed rod panic bars	9 9mm	-		U	-
																	6 ²															
																	7 ²															
AJ BLE HID iCLASS			6					60				7 ²	00	IP ²		P ³ For concealed rod panic bars	9 9mm								-				U	-		
												8 ²																				
												9 ²																				

Model Ax650xHxK

SALTO XS4 Electronic Half Escutcheon Ax650 with keypad for panic bar, 1 handle, any type.

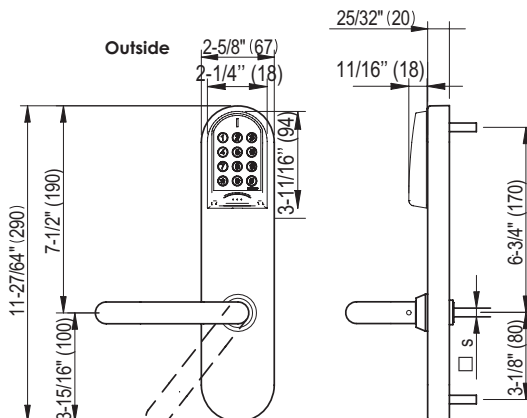
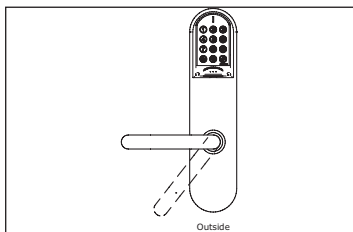

¹ For Handed lever handles, only for S, O or K handles.

² This option has an additional price please refer to the handles or finishes chapter.

Gain durability feature included by default.

This model has to be installed in combination with a wireless KPB even if wireless capabilities are not required

Prices - Gross prices		€
	BLE MIFARE - DESFire: Standard - standard square spindles, finishes and handles.	442,65
	BLE MIFARE - DESFire: Wireless - standard square spindles, finishes and handles.	485,65
	BLE HID iCLASS: Standard - standard square spindles, finishes and handles.	544,10
	BLE HID iCLASS: Wireless - standard square spindles, finishes and handles.	587,10

Technology	Escutcheon width	Function	Handle	Handle to thumbturn	Finish	Door Thickness	Square spindle	Handing	Wireless	Keypad option
AB BLE MIFARE DESFire	6	50	U	00 without distance	IM	H	8 8mm	-	- standalone	K Key pad option
			L							
			W							
			A							
			H ²							
			Y ²							
			S ^{1,2}							
			B ²							
			P ²							
			O ¹							
AJ BLE HID iCLASS	6	50	J	00 without distance	IP ²	P ³ For concealed rod panic bars	8 8mm	R/L ¹	W wireless online	K Key pad option
			T							
			Z							
			K ¹							
			2 ²							
			3 ²							
			4 ²							
			5 ²							
7 ²										

³ Half escutcheon model, only compatible for Von Duprin 98 / 9957 concealed vertical rod panic bar.

Model Ax660xHxK

SALTO XS4 Electronic Half Escutcheon Ax660 with keypad for panic bar, 1 handle, any type, built in mechanical cylinder with audit. (mechanical cylinder not included, for technical specifications consult SALTO).

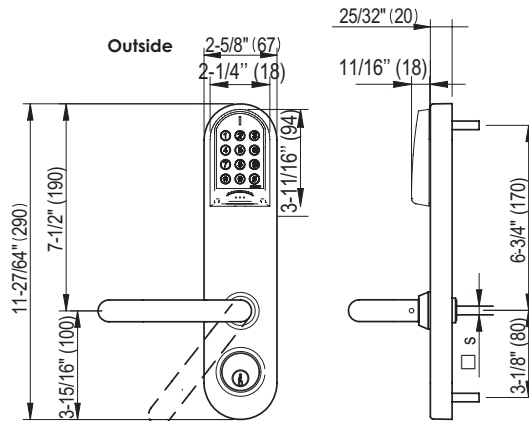
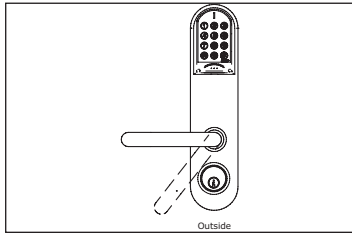

¹ For Handed lever handles, only for S, O or K handles.

² This option has an additional price please refer to the handles or finishes chapter.

Gain durability feature included by default.

This model has to be installed in combination with a wireless KPB even if wireless capabilities are not required

Prices - Gross prices	€
MIFARE DESFire BLE MIFARE - DESFire: Standard - standard square spindles, finishes and handles.	448,85
BLE MIFARE - DESFire: Wireless - standard square spindles, finishes and handles.	491,95
iCLASS BLE HID iCLASS: Standard - standard square spindles, finishes and handles.	550,35
BLE HID iCLASS: Wireless - standard square spindles, finishes and handles.	593,25

Technology	Escutcheon width	Function	Handle	Handle to thumbturn	Finish	Door Thickness	Square spindle	Handing	Wireless	Keypad option
AB BLE MIFARE DESFire	6	60	U	00 without distance	IM	H	8 8mm	-	- standalone	K Key pad option
			L							
			W							
			A							
			H ²							
			Y ²							
			S ^{1,2}							
			B ²							
			P ²							
			O ¹							
AJ BLE HID iCLASS	6	60	J	IP ²	P ³ For concealed rod panic bars	8 8mm	R/L ¹	W wireless online	K Key pad option	
			T							
			Z							
			K ¹							
			2 ²							
			3 ²							
			4 ²							
			5 ²							
7 ²										

³ Half escutcheon model, only compatible for Von Duprin 98 / 9957 concealed vertical rod panic bar.

Model Sx450xH

SALTO XS4 Electronic Half Escutcheon Sx450 for panic bar, 1 handle, any type.

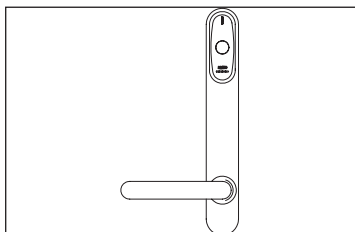

Prices - Gross prices	€
Picopass: Standard - standard square spindles, finishes and handles.	359,00
Picopass: Wireless - standard square spindles, finishes and handles.	394,95
Picopass: AMOK - standard square spindles, finishes and handles.	394,95
Legic Advant: Standard - standard square spindles, finishes and handles.	341,85
Legic Advant: Wireless - standard square spindles, finishes and handles.	377,85
Legic Advant: AMOK - standard square spindles, finishes and handles.	377,85
Mifare - DESFire: Standard - standard square spindles, finishes and handles.	341,85
Mifare - DESFire: Wireless - standard square spindles, finishes and handles.	377,85
Mifare - DESFire: AMOK - standard square spindles, finishes and handles.	460,75
BLE Mifare DESFire: additional price to add to the Mifare DESFire price. Gross price	27,70
HID iCLASS: Standard - standard square spindles, finishes and handles.	424,35
HID iCLASS: Wireless - standard square spindles, finishes and handles.	460,35
HID iCLASS: AMOK - standard square spindles, finishes and handles.	543,35
BLE HID iCLASS: additional price to add to the HID iCLASS price. Gross price	27,70

¹ For Handed lever handles, only for S, O or K handles.

² This option has an additional price please refer to the handles or finishes chapter.





Gain durability feature included by default.

Technology	Escutcheon width	Function	Handle	Handle to thumbturn	Finish	Door thickness	Square spindle	Handing	Wireless						
S7 PICOPASS	4	50	U	without distance	IM	H	8 8mm	-	offline stand-alone						
			L												
			W												
A															
H ²															
Y ²															
S8 LEGIC			4		50			S ^{1,2}	without distance	IM	H	8 8mm	R/L ¹	W	
								B ²							
								P ²							
O ¹								IP ²					R/L ¹		wireless online
J															
T															
Z															
K ¹	A	R/L ¹		Amok											
2 ²															
3 ²															
4 ²															
5 ²															
7 ²															

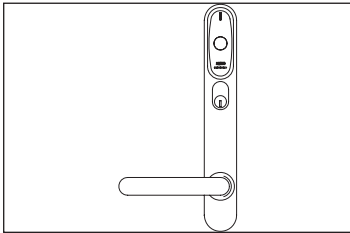
Model Sx454xH

SALTO XS4 Electronic Half Escutcheon Sx454for panic bar, 1 handle, any type, outside cylinder cut out. (cylinder not included).



Prices - Gross prices		€
	Picopass: Standard - standard square spindles, finishes and handles.	357,55
	Picopass: Wireless - standard square spindles, finishes and handles.	393,50
	Picopass: AMOK - standard square spindles, finishes and handles.	393,50
	Legic Advant: Standard - standard square spindles, finishes and handles.	340,70
	Legic Advant: Wireless - standard square spindles, finishes and handles.	376,60
	Legic Advant: AMOK - standard square spindles, finishes and handles.	376,60
MIFARE DESFire	Mifare - DESFire: Standard - standard square spindles, finishes and handles.	340,70
	Mifare - DESFire: Wireless - standard square spindles, finishes and handles.	376,60
	Mifare - DESFire: AMOK - standard square spindles, finishes and handles.	459,15
	BLE Mifare DESFire: additional price to add to the Mifare DESFire price. Gross price	27,70
	HID iCLASS: Standard - standard square spindles, finishes and handles.	432,25
	HID iCLASS: Wireless - standard square spindles, finishes and handles.	468,30
	HID iCLASS: AMOK - standard square spindles, finishes and handles.	553,50
	BLE HID iCLASS: additional price to add to the HID iCLASS price. Gross price	27,70

¹ For Handed lever handles, only for S, O or K handles.

² This option has an additional price please refer to the handles or finishes chapter.

Gain durability feature included by default.

Technology	Escutcheon width	Function	Handle	Handle to thumbturn	Finish	Door thickness	Square spindle	Handing	Wireless					
S7 PICOPASS	4	54	U	05	IM	H	8 8mm	-	- offline standa- lone					
			L											
			W											
A														
H ²														
Y ²														
S8 LEGIC			4		54			S ^{1,2}	05	IM	H	8 8mm	R/L ¹	- W wireless online
								B ²						
								P ²						
O ¹														
J														
T														
S9 MIFARE	4	54		Z		05	IM	H		8 8mm			-	- A Amok
				K ¹										
				2 ²										
3 ²														
4 ²														
5 ²														
SB MIFARE BLE			4	54	7 ²		05		IP ²		H	8 8mm	R/L ¹	- A Amok
					T									
					Z									
K ¹														
2 ²														
3 ²														
SH HID iCLASS	4	54			4 ²	05		IP ²	H	8 8mm			-	- A Amok
					5 ²									
					7 ²									
7 ²														
7 ²														
7 ²														

Model Sx650xH

SALTO XS4 Electronic Half Escutcheon Sx650 for panic bar, 1 handle, any type.

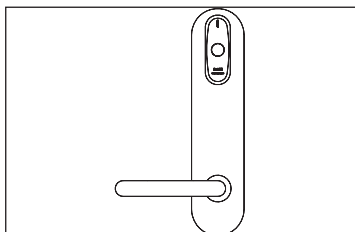

Prices - Gross prices	€
Picopass: Standard - standard square spindles, finishes and handles.	380,50
Picopass: Wireless - standard square spindles, finishes and handles.	416,35
Picopass: AMOK - standard square spindles, finishes and handles.	416,35
Legic Advant: Standard - standard square spindles, finishes and handles.	362,30
Legic Advant: Wireless - standard square spindles, finishes and handles.	398,45
Legic Advant: AMOK - standard square spindles, finishes and handles.	398,45
Mifare - DESFire: Standard - standard square spindles, finishes and handles.	362,30
Mifare - DESFire: Wireless - standard square spindles, finishes and handles.	398,45
Mifare - DESFire: AMOK - standard square spindles, finishes and handles.	488,25
BLE Mifare DESFire: additional price to add to the Mifare DESFire price. Gross price	27,70
HID iCLASS: Standard - standard square spindles, finishes and handles.	444,90
HID iCLASS: Wireless - standard square spindles, finishes and handles.	480,65
HID iCLASS: AMOK - standard square spindles, finishes and handles.	569,65
BLE HID iCLASS: additional price to add to the HID iCLASS price. Gross price	27,70

¹ For Handed lever handles, only for S, O or K handles.

² This option has an additional price please refer to the handles or finishes chapter.

Gain durability feature included by default.

Technology	Escutcheon width	Function	Handle	Handle to thumbturn	Finish	Door thickness	Square spindle	Handing	Wireless																	
S7 PICOPASS	6	50	U	00 without distance	IM	H	8 8mm	-	offline standalone																	
			L																							
			W																							
A																										
H ²																										
Y ²																										
S8 LEGIC			6		50			S ^{1,2}	00 without distance	IM	H	8 8mm	R/L ¹	W wireless online												
								B ²																		
								P ²																		
O ¹																										
J																										
T																										
S9 MIFARE	6	50		Z		00 without distance	IM	H		8 8mm			-	W wireless online												
				K ¹																						
				2 ²																						
SB MIFARE BLE				6									50		3 ²	00 without distance	IP ²	H	8 8mm	R/L ¹	A Amok					
															4 ²											
															5 ²											
SH HID iCLASS			6		50		7 ²		00 without distance		IP ²	H		8 8mm	-					A Amok						
							-																			
							-																			
SJ BLE HID iCLASS							6								50		-				00 without distance	IP ²	H	8 8mm	-	A Amok
																	-									
																	-									

Model Sx654xH

SALTO XS4 Electronic Half Escutcheon Sx654 for panic bar, 1 handle, any type, outside cylinder cut out. (cylinder not included).

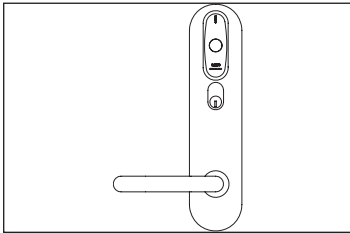

Prices - Gross prices		€
	Picopass: Standard - standard square spindles, finishes and handles.	379,05
	Picopass: Wireless - standard square spindles, finishes and handles.	415,10
	Picopass: AMOK - standard square spindles, finishes and handles.	415,10
	Legic Advant: Standard - standard square spindles, finishes and handles.	362,30
	Legic Advant: Wireless - standard square spindles, finishes and handles.	398,45
	Legic Advant: AMOK - standard square spindles, finishes and handles.	398,45
	Mifare - DESFire: Standard - standard square spindles, finishes and handles.	362,30
	Mifare - DESFire: Wireless - standard square spindles, finishes and handles.	398,45
	Mifare - DESFire: AMOK - standard square spindles, finishes and handles.	488,25
	BLE Mifare DESFire: additional price to add to the Mifare DESFire price. Gross price	27,70
	HID iCLASS: Standard - standard square spindles, finishes and handles.	390,00
	HID iCLASS: Wireless - standard square spindles, finishes and handles.	426,05
	HID iCLASS: AMOK - standard square spindles, finishes and handles.	515,95
	BLE HID iCLASS: additional price to add to the HID iCLASS price. Gross price	27,70

¹ For Handed lever handles, only for S, O or K handles.

² This option has an additional price please refer to the handles or finishes chapter.

Gain durability feature included by default.

Technology	Escutcheon width	Function	Handle	Handle to thumbturn	Finish	Door thickness	Square spindle	Handing	Wireless																	
S7 PICOPASS	6	54	U	05	IM	H	8 8mm	-	- offline standalone																	
			L																							
			W																							
A																										
H ²																										
Y ²																										
S8 LEGIC			6		54			S ^{1,2}	05	IM	H	8 8mm	R/L ¹	- W wireless online												
								B ²																		
								P ²																		
O ¹																										
J																										
T																										
S9 MIFARE	6	54		Z		05	IM	H		8 8mm			-	- A Amok												
				K ¹																						
				2 ²																						
SB MIFARE BLE				6									54		3 ²	05	IP ²	H	8 8mm	R/L ¹	- A Amok					
															4 ²											
															5 ²											
SH HID iCLASS			6		54		7 ²		05		IP ²	H		8 8mm	-					- A Amok						
							-																			
							-																			
SJ BLE HID iCLASS							6								54		-				05	IP ²	H	8 8mm	-	- A Amok
																	-									
																	-									

Model Sx650xHxK

SALTO XS4 Electronic Half Escutcheon Sx650 with keypad for panic bar, 1 handle, any type.

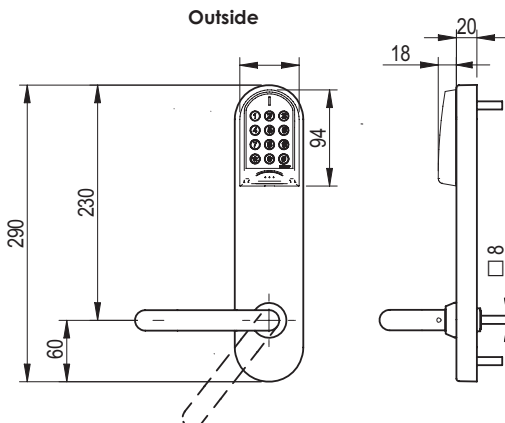
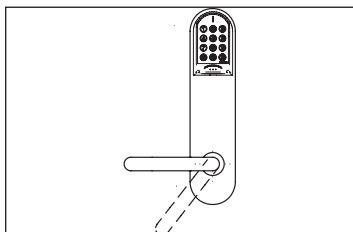

¹ For Handed lever handles, only for S, O or K handles.

² This option has an additional price please refer to the handles or finishes chapter.

Gain durability feature included by default.

This model has to be installed in combination with a wireless KPB even if wireless capabilities are not required

Prices - Gross prices		€
MIFARE DESFire	BLE MIFARE - DESFire: Standard - standard square spindles, finishes and handles.	462,55
	BLE MIFARE - DESFire: Wireless - standard square spindles, finishes and handles.	505,75
iCLASS	BLE HID iCLASS: Standard - standard square spindles, finishes and handles.	561,10
	BLE HID iCLASS: Wireless - standard square spindles, finishes and handles.	604,00

Technology	Escutcheon width	Function	Handle	Handle to thumbturn	Finish	Door Thickness	Square spindle	Handing	Wireless	Keypad option
SB BLE MIFARE DESFire	6	50	U	00 without distance	IM	H	8 8mm	-	-	K Key pad option
			L							
			W							
			A							
			H ²							
			Y ²							
			S ^{1,2}							
			B ²							
			P ²							
			O ¹							
SJ BLE HID iCLASS	6	50	J	00 without distance	IP ²	H	8 8mm	R/L ¹	W wireless online	K Key pad option
			T							
			Z							
			K ¹							
			2 ²							
			3 ²							
			4 ²							
			5 ²							
7 ²										

Model Sx654xHxK

SALTO XS4 Electronic Half Escutcheon Sx654 with keypad for panic bar, 1 handle, any type, outside cylinder cut out. (cylinder not included).

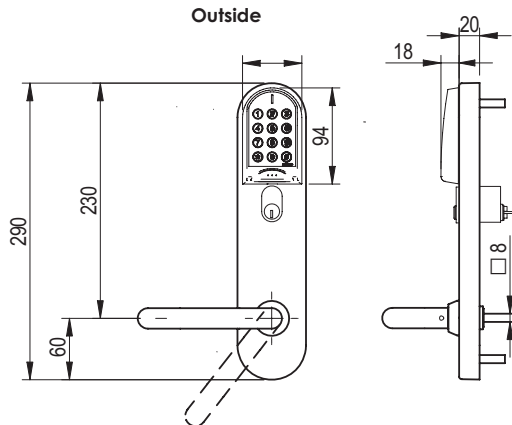
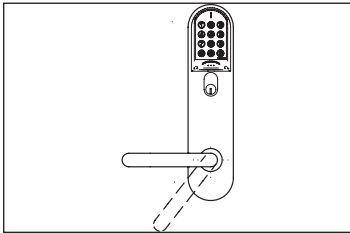

¹ For Handed lever handles, only for S, O or K handle.



² This option has an additional price, please refer to the handles or finishes chapter.

Gain durability feature included by default.

This model has to be installed in combination with a wireless KPB even if wireless capabilities are not required

Prices - Gross prices		€
	BLE MIFARE - DESFire: Standard - standard square spindles, finishes and handles.	462,55
	BLE MIFARE - DESFire: Wireless - standard square spindles, finishes and handles.	505,75
	BLE HID iCLASS: Standard - standard square spindles, finishes and handles.	570,35
	BLE HID iCLASS: Wireless - standard square spindles, finishes and handles.	613,55

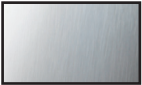
Technology	Escutcheon width	Function	Handle	Handle to thumbturn	Finish	Door Thickness	Square spindle	Handing	Wireless	Keypad option	
SB BLE MIFARE DESFire	6	60	U	00 without distance	IM	H	8 8mm	-	-	standalone	K Key pad option
			L								
			W								
			A								
			H ²								
			Y ²								
			S ^{1,2}								
			B ²								
			P ²								
			O ¹								
SJ BLE HID iCLASS	6	60	J	00 without distance	IP ²	H	8 8mm	R/L ¹	-	W wireless online	K Key pad option
			T								
			Z								
			K ¹								
			2 ²								
			3 ²								
			4 ²								
			5 ²								
7 ²											

Product description	Product reference	€
Stainless steel finishes		
Satin stainless steel 	E X X X X X X I M X X	0,00
Polished stainless steel 	E X X X X X X I P X X	15,70
RAL colours		
Black 	E X X X X X X N E X X	24,90

Example of price calculation for finishes other than Satin Stainless (IM), which is the standard used in our price list.

Required is E9450UHNE1 escutcheon.	€
E9450UHIM1	325,30
Additional price for Black finish	24,90
Total Price:	350,20

Only those handles regarded as off-set handles have an add-on to the price of the standard escutcheon. 2 remarks:

- Prices are gross and per handle, so an Ex650 model, for instance, needs 2 handles in the case of an off-set model.
- Prices refer to the IM finish, so please refer to the finishes pricelist in order to establish final price of the product.

Handles

FINISH MODEL	S SATIN STAINLESS STEEL	P POLISHED STAINLESS STEEL	B BLACK	Spindle available			Gross price
				DUAL 8-7 ^{Diamond}	8	9	
				IM	IP	NE	
	U	✓	✓	✓			0,00
	L	✓	✓	✓			0,00
	W	✓	✓	✓			0,00
	H	✓		✓			30,15
	S	✓		✓			30,15
	B	✓		✓			71,05
	P	✓		✓			44,35
	J	✓		✓			0,00
	T	✓		✓			0,00
	Y	✓	✓	✓			30,15
	Z	✓		✓			0,00
	K	✓	✓				0,00
	2	✓	✓				37,30
	3	✓	✓				37,30
	4	✓	✓				37,30
	7	✓	✓				37,30
	5	✓	✓				37,30

Model PBE900

SALTO PBE panic bar, tested according to EN 1125, in combination with GBS91 or GBS92 and SALTO escutcheon and KPB0, KPB02 or KPB40. Max 1150mm wing width, angle turn 30° or 45° depending on the model. (ECO Schulte EPN 900)

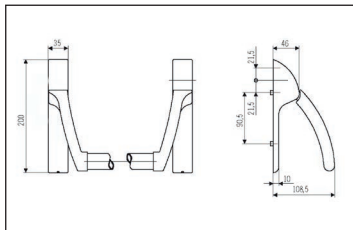

! Check Mortise locks and escutcheon compatibilities in the KPB chapter.

¹ Panic bar made of Nylon.
² Panic bar made of Stainless steel

Prices - Gross prices					€
Product	Model	Cylinder cut out distance	Mechanism	Finish	
PB	E90	00 without cut out	30 30°angle turn	RE ¹ Red bar	240,15
PB	E90	00 without cut out	30 30°angle turn	GR ¹ Green bar	240,15
PB	E90	00 without cut out	45 45°angle turn	RE ¹ Red bar	240,15
PB	E90	00 without cut out	45 45°angle turn	GR ¹ Green bar	240,15
PB	E90	00 without cut out	30 30°angle turn	IM ² Satin Stainless Steel	687,45
PB	E90	00 without cut out	45 45°angle turn	IM ² Satin Stainless Steel	687,45

Advanced panic bar solutions - Mortise locks for panic bars

Model LE7E

SALTO Automatic lock for wooden and steel doors. Automatic deadbolt through, EN1125 compliant in combination only KPB01, ECO EPN 900, and SALTO compatible handle set. Distance PZ72, turning Angle 45° .

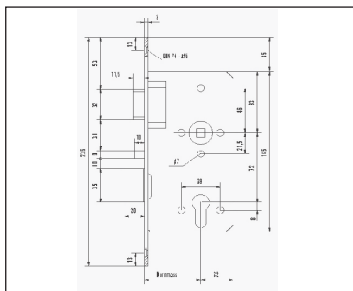

! Check Mortise locks and escutcheon compatibilities on the KPB chapter.
On stock LE7E3155R40IM9 L/R for other consult SALTO / Strike plate not included
¹ handed mortise lock. not reversible.

Prices - Gross prices							€
Model	Backset	Front plate		Door detector	Finishes	Square spindle	Handing
		Shape	Size				
LE7E31	55	R	0 20mm	0 no detector	IM	9	R ¹
	65		4 24mm				L ¹

Model LE9E

SALTO Panic lock for doors with profiled frame. Panic lock for movable wing. EN1125 compliant in combination with KPB01 and KPB02, ECO EPN 900, and SALTO compatible handle set. Distance PZ 92, turning angle 30°.

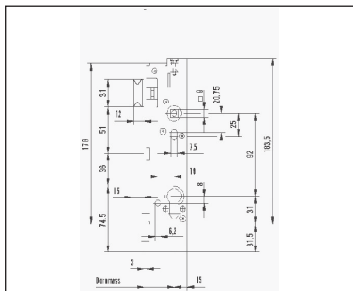

! Check Mortise locks and escutcheon compatibilities on the KPB chapter.
! On stock LE9E1130C40IM9 for other consult SALTO.

Prices - Gross prices							€
Model	Backset	Front plate		Door detector	Finishes	Square spindle	Handing
		Shape	Size				
LE9E11	30	C	4 24mm	0 no detector	IM	9	- R/L reversible
	35						
	40						
	45						

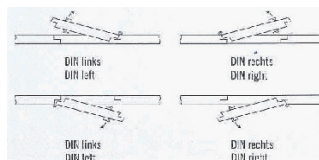

Model PBA120

SALTO PBA panic bar, tested according to EN 1125, in combination with LE7A0165R40IM and SALTO escutcheon and KPB33.
Max 1150mm wing width.

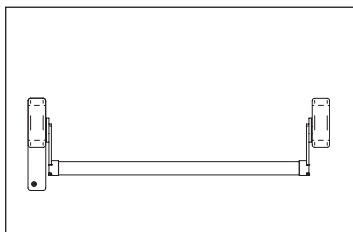

Check Mortise locks and escutcheon compatibilities in the KPB chapter.

¹ Panic bar made of Nylon.
² Panic bar made of Galvanized steel

Prices - Gross prices					€
Product	Model	Cylinder cut out distance	Mechanism	Finish	
PB	A12	00 without cut out	20 20°angle turn	RE ¹ Red bar	200,15
PB	A12	00 without cut out	20 20°angle turn	GR ¹ Green bar	200,15
PB	A12	00 without cut out	20 20°angle turn	IM ² Satin Stainless Steel	324,30



Advanced panic bar solutions - Mortise locks for panic bars

Model LE7A

SALTO Automatic lock for wooden and steel doors. Automatic deadbolt through, EN1125 compliant in combination with KPB33, PBA120, and SALTO compatible handle set. Distance PZ72, turning Angle 20°.

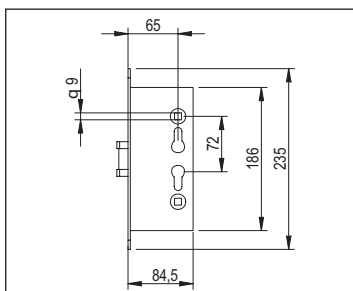

Prices - Gross prices								€
Model	Backset	Front plate		Door detector	Finishes	Square spindle	Handing	
		Shape	Size					
LE7A01	65	R	4 24mm	0 no detector	IM	V	- R/L reversible	59,20

Mortise locks to be used with PBA120 only.

Model LE7A00 for passive leaf

SALTO Mortise lock for panic bar (passive leaf), tested according to EN 1125, The Kit Includes, passive mortise lock and locking mechanisms.
Max 1150mm wing width.

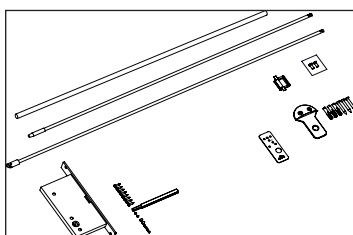

Prices - Gross prices								€
Model	Backset	Front plate		Door detector	Finishes	Square spindle	Handing	
		Shape	Size					
LE7A00	65	C	4 24mm	0 no detector	IM	V	- R/L reversible	153,25

Model PBF110

SALTO RIM Panic Bar Device. Stainless steel finish.

Latchdeadlocking system. Max 1220mm wing width. Strike plate included. To be used with KPB03.
Exit signal when bar is depressed included.

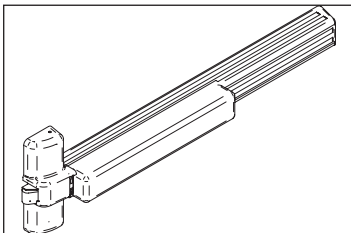

! Check Mortise locks and escutcheon compatibilities in the KPB chapter.

UL10C compliant 3 hours fire rated

Prices - Gross prices					€
Product	Model	Cylinder cut out distance	Length	Finish	
PB	F11	00 without cut out	33 711mm up to 915mm	IM Satin Stainless Steel	855,25
PB	F11	00 without cut out	45 864mm up to 1220mm	IM Satin Stainless Steel	855,25

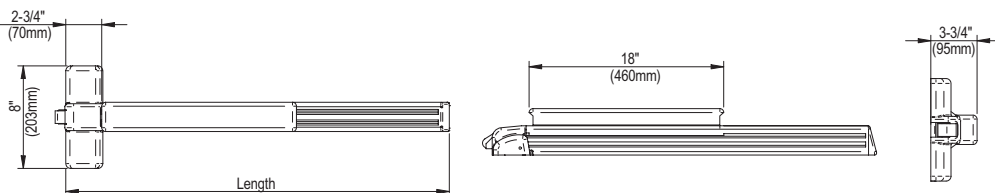

SALTO electronic compatibilities

XS4

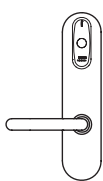

Escutcheons Models

Ai650m00ffH8
Ai660m00ffH8
+
KPB03xx

* Exit detection only with KPB03xxW

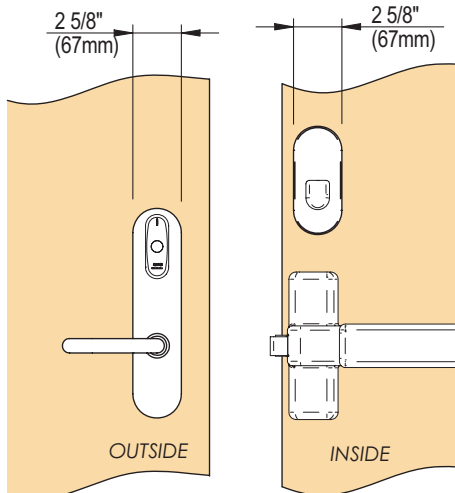

GEO CYLINDER

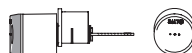

Rim Cylinders

-Gi**B1**100N00ffN
(ANSI UNC Screws)
-Gi**K1**100N00ffN
(ISO METRIC Screws)

* No exit detection

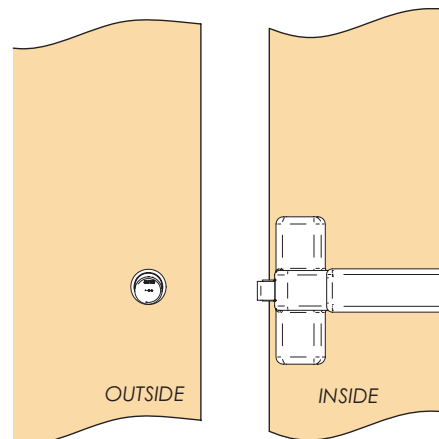

KPB01

SALTO XS4 Panic Bar Kit for versions of ECO and BKS.

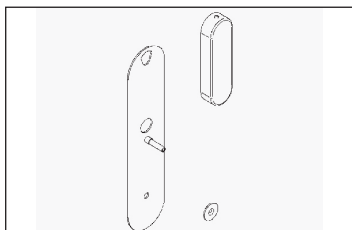

Prices - Gross prices			€
Product	Finish	Offline stand alone or Wireless online	
KPB01IM	Stainless steel finish	Offline stand alone	132,35
KPB01IP	Polished stainless steel finish	Offline stand alone	151,00
KPB01IMW	Stainless steel finish	Wireless online	255,05
KPB01IPW	Polished stainless steel finish	Wireless online	273,75
KPB01IMA7	Stainless steel finish	Amok Picopass	178,35
KPB01IPA7	Polished stainless steel finish	Amok Picopass	203,55
KPB01IMA8	Stainless steel finish	Amok LEGIC Advant	167,95
KPB01IPA8	Polished stainless steel finish	Amok LEGIC Advant	191,70
KPB01IMA9	Stainless steel finish	Amok Mifare DESFire	167,95
KPB01IPA9	Polished stainless steel finish	Amok Mifare DESFire	191,70
KPB01IMAH	Stainless steel finish	Amok HID iCLASS	195,75
KPB01IPAH	Polished stainless steel finish	Amok HID iCLASS	223,40

Panic bar	Mortise Lock Needed	Mortise Lock Drawing	Escutcheon Needed	Note
BKS B7100 61	BKS 2126 (Automatic)		Ei650m00ffH9 Ei654m72ffH9 Ei660m00ffH9 Ei6E0m00ffH9 Ei6P0m00ffH9	Wireless Possible (Except split spindle)
	BKS 1926 (Automatic)		Ei650m00ffH9 Ei654m92ffH9 Ei660m00ffH9 Ei6E0m00ffH9 Ei6P0m00ffH9	Wireless Possible (Except split spindle)
BKS B7150	BKS 1926 (Automatic)		Ei650m00ffH9 Ei654m92ffH9 Ei660m00ffH9 Ei6E0m00ffH9 Ei6P0m00ffH9	Wireless Possible (Except split spindle)
BKS B7172 51 BKS B7100 51	BKS 2126 (Automatic)		Ei650m7FffH9 Ei654m7FffH9 Ei6E0m7FffH9	Wireless Possible (Except split spindle) Only 7F models
	BKS 1926 (Automatic)		Ei650m7FffH9 Ei6E0m7FffH9	Wireless Possible (Except split spindle) Only 7F models
ECO EPN 900-45° ECO	ECO GBS 91 C ECO GBS 92 C ECO GBS 93 C ECO GBS 94 C		Ei650m7FffH9 Ei654m7FffH9 Ei6E0m7FffH9	EN1125 Compliant Wireless Possible (Except split spindle) Only 7F models
ECO EPN 900-30°	DIN 18250 72PZ		Ei650m7FffH9 Ei654m7FffH9 Ei6E0m7FffH9	Wireless Possible (Except Split Spindle) Only 7F models
	ECO GBS 96 C ECO GBS 97 C ECO GBS 98 C		Ei650m7FffH9 Ei6E0m7FffH9	EN1125 Compliant Wireless Possible (Except split spindle)
ECO EPN 2000	DIN 18250 72PZ		Ei650m00ffH9 Ei654m72ffH9 Ei660M00ffH9 Ei6E0m00ffH9 Ei6P0m00ffH9	Wireless Possible (Except Split Spindle)
	ECO GBS 96 C ECO GBS 97 C		Ei650m00ffH9 Ei654m92ffH9 Ei660m00ffH9 Ei6E0m00ffH9 Ei6P0m00ffH9	Wireless Possible (Except Split Spindle)

KPB02

SALTO XS4 Panic Bar Kit for versions of ECO and BKS.

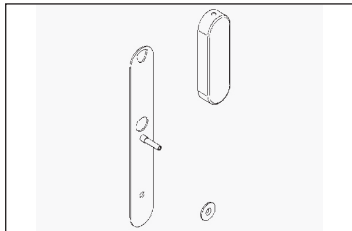

Prices - Gross prices			€
Product	Finish	Offline stand alone or Wireless online	
KPB02IM	Stainless steel finish	Offline stand alone	126,55
KPB02IP	Polished stainless steel finish	Offline stand alone	145,10
KPB02IMW	Stainless steel finish	Wireless online	249,30
KPB02IPW	Polished stainless steel finish	Wireless online	268,05
KPB02IMA7	Stainless steel finish	Amok Picopass	170,60
KPB02IPA7	Polished stainless steel finish	Amok Picopass	195,85
KPB02IMA8	Stainless steel finish	Amok LEGIC Advant	160,60
KPB02IPA8	Polished stainless steel finish	Amok LEGIC Advant	184,35
KPB02IMA9	Stainless steel finish	Amok Mifare DESFire	160,60
KPB02IPA9	Polished stainless steel finish	Amok Mifare DESFire	184,35
KPB02IMAH	Stainless steel finish	Amok HID iCLASS	187,30
KPB02IPAH	Polished stainless steel finish	Amok HID iCLASS	214,95

Panic Bar	Mortise Lock Needed	Mortise Lock Drawing	Escutcheon Needed	Note
BKS B7100 61	BKS 2126 (Automatic)		Ei450m00ffH9 Ei454m72ffH9 Ei460m00ffH9 Ei6P0m00ffH9	Wireless Possible (Except Split Spindle)
	BKS 1926 (Automatic)		Ei450m00ffH9 Ei454m92ffH9 Ei460m00ffH9 Ei4P0m00ffH9	Wireless Possible (Except Split Spindle)
BKS B7150	BKS 1926 (Automatic)		Ei450m00ffH9 Ei454m92ffH9 Ei460m00ffH9 Ei6P0m00ffH9	Wireless Possible (Except Split Spindle)
BKS B7172 51 BKS B7100 51	BKS 2126 (Automatic)		Ei450m7FffH9 Ei454m7FffH9 Ei460m7FffH9	Wireless Possible (Except Split Spindle) Only 7F Models
	BKS 1926 (Automatic)		Ei450m7FffH9 Ei460m7FffH9	Wireless Possible (Except Split Spindle) Only 7F Models
ECO EPN 900-30°	DIN 18250 72PZ		Ei450m7FffH9 Ei454m7FffH9 Ei460m7FffH9	Wireless Possible (Except Split Spindle) Only 7F Models
	ECO GBS 96 C ECO GBS 97 C ECO GBS 98 C		Ei450m7FffH9 Ei460m7FffH9	EN1125 Compliant Wireless Possible (Except Split Spindle) Only 7F Models
ECO EPN 2000	DIN 18250 72PZ		Ei450m00ffH9 Ei454m72ffH9 Ei460M00ffH9 Ei4P0m00ffH9	Wireless Possible (Except Split Spindle)
	ECO GBS 96 C ECO GBS 97 C		Ei450m00ffH9 Ei454m92ffH9 Ei460m00ffH9 Ei4P0m00ffH9	Wireless Possible (Except Split Spindle)

KPB03

SALTO XS4 Panic Bar Kit for versions of VON DUPRIN.

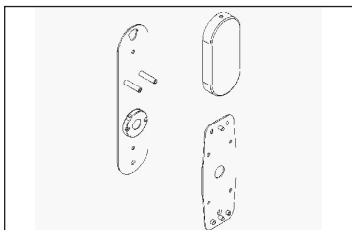

Prices - Gross prices			€
Product	Finish	Offline stand alone or Wireless online	
KPB03IM	Stainless steel finish	Offline stand alone	201,40
KPB03IMU	Stainless steel finish	Offline stand alone UL-listed*	
KPB03IP	Polished stainless steel finish	Offline stand alone	220,15
KPB03IPU	Polished stainless steel finish	Offline stand alone UL-listed*	
KPB03IMW	Stainless steel finish	Wireless online	324,20
KPB03IPW	Polished stainless steel finish	Wireless online	342,30
KPB03IMA7	Stainless steel finish	Amok Picopass	271,45
KPB03IPA7	Polished stainless steel finish	Amok Picopass	296,80
KPB03IMA8	Stainless steel finish	Amok LEGIC Advant	255,60
KPB03IPA8	Polished stainless steel finish	Amok LEGIC Advant	279,45
KPB03IMA9	Stainless steel finish	Amok Mifare DESFire	255,60
KPB03IPA9	Polished stainless steel finish	Amok Mifare DESFire	279,45
KPB03IMAH	Stainless steel finish	Amok HID iCLASS	298,00
KPB03IPAH	Polished stainless steel finish	Amok HID iCLASS	325,75

Panic Bar	Mortise Lock Needed	Mortise Lock Drawing	Escutcheon Needed	Note
Von Duprin 98 (single point)			Ai650m00ffH8 Ai660m00ffH8	Opening from the inside detection not possible
Von Duprin 99 (single point)			Ai650m00ffH8 Ai660m00ffH8	



Wireless version available - no inside handle opening detection.

* UL Listed in combination with SALTO PBF1100 RIM panic bar and SALTO ANSI escutcheon Ax650xxxH8U series. If used with a panic bar device from another manufacturer, the UL listing does not apply.

KPB04

SALTO XS4 Panic Bar Kit for versions of VON DUPRIN.

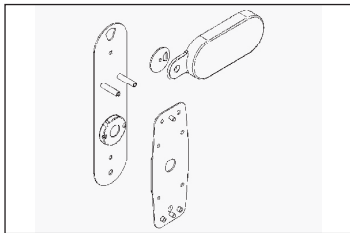

Prices - Gross prices			€
Product	Finish	Offline stand alone or Wireless online	
KPB04IM	Stainless steel finish	Offline stand alone	222,95
KPB04IP	Polished stainless steel finish	Offline stand alone	241,60
KPB04IMW	Stainless steel finish	Wireless online	345,75
KPB04IPW	Polished stainless steel finish	Wireless online	363,85
KPB04IMA7	Stainless steel finish	Amok Picopass	300,60
KPB04IPA7	Polished stainless steel finish	Amok Picopass	325,70
KPB04IMA8	Stainless steel finish	Amok LEGIC Advant	283,00
KPB04IPA8	Polished stainless steel finish	Amok LEGIC Advant	306,65
KPB04IMA9	Stainless steel finish	Amok Mifare DESFire	283,00
KPB04IPA9	Polished stainless steel finish	Amok Mifare DESFire	306,65
KPB04IMAH	Stainless steel finish	Amok HID iCLASS	329,90
KPB04IPAH	Polished stainless steel finish	Amok HID iCLASS	357,55



Wireless version available - no inside handle opening detection.

Panic Bar	Mortise Lock Needed	Mortise Lock Drawing	Escutcheon Needed	Note
Von Duprin 9857 Von Duprin 9957 (3 locking points)			Ai650m00ffH8 Ai660m00ffH8	Opening from the inside detection not possible
Von Duprin 98/9927 (2 locking points)			Ai650m00ffH8 Ai660m00ffH8	

KPB05

SALTO XS4 Panic Bar Kit for versions of TINKO.

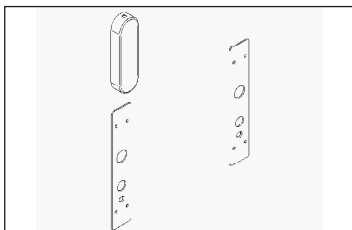

Prices - Gross prices			€
Product	Finish	Offline stand alone or Wireless online	
KPB05IM	Stainless steel finish	Offline stand alone	130,80
KPB05IP	Polished stainless steel finish	Offline stand alone	149,55
KPB05IMW	Stainless steel finish	Wireless online	253,60
KPB05IPW	Polished stainless steel finish	Wireless online	271,75
KPB05IMA7	Stainless steel finish	Amok Picopass	176,40
KPB05IPA7	Polished stainless steel finish	Amok Picopass	201,70
KPB05IMA8	Stainless steel finish	Amok LEGIC Advant	166,10
KPB05IPA8	Polished stainless steel finish	Amok LEGIC Advant	189,90
KPB05IMA9	Stainless steel finish	Amok Mifare DESFire	166,10
KPB05IPA9	Polished stainless steel finish	Amok Mifare DESFire	189,90
KPB05IMAH	Stainless steel finish	Amok HID iCLASS	193,65
KPB05IPAH	Polished stainless steel finish	Amok HID iCLASS	221,30



Wireless version available
 No inside handle opening
 detection.

Panic Bar	Mortise Lock Needed	Mortise lock drawing	Escutcheon Needed	Note
TINKO 5000 (Single point)			Ai650m00ff-Hx Ai660m00ff-Hx	Opening from the inside detection not possible

KPB06

SALTO XS4 Panic Bar Kit for versions of VACHETTE.

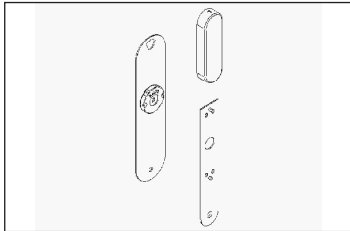

Prices - Gross prices			€
Product	Finish	Offline stand alone or Wireless online	
KPB06IM	Stainless steel finish	Offline stand alone	151,00
KPB06IP	Polished stainless steel finish	Offline stand alone	169,65
KPB06IMW	Stainless steel finish	Wireless online	273,75
KPB06IPW	Polished stainless steel finish	Wireless online	292,30
KPB06IMA7	Stainless steel finish	Amok Picopass	203,55
KPB06IPA7	Polished stainless steel finish	Amok Picopass	228,85
KPB06IMA8	Stainless steel finish	Amok LEGIC Advant	191,70
KPB06IPA8	Polished stainless steel finish	Amok LEGIC Advant	215,45
KPB06IMA9	Stainless steel finish	Amok Mifare DESFire	191,70
KPB06IPA9	Polished stainless steel finish	Amok Mifare DESFire	215,45
KPB06IMAH	Stainless steel finish	Amok HID iCLASS	223,40
KPB06IPAH	Polished stainless steel finish	Amok HID iCLASS	251,10

Panic Bar	Mortise Lock Needed	Mortise Lock Drawing	Escutcheon Needed	Note
Vachette 6710 (Single ponit)			Ei650m00ffH8 Ei660m00ffH8 Ei6E0m00ffH8 Ei6P0m00ffH8	Wireless Possible

KPB07

SALTO XS4 Panic Bar Kit for versions of VACHETTE.

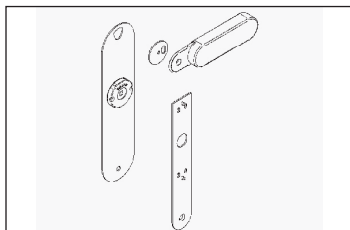

Prices - Gross prices			€
Product	Finish	Offline stand alone or Wireless online	
KPB07IM	Stainless steel finish	Offline stand alone	168,30
KPB07IP	Polished stainless steel finish	Offline stand alone	186,95
KPB07IMW	Stainless steel finish	Wireless online	291,00
KPB07IPW	Polished stainless steel finish	Wireless online	309,60
KPB07IMA7	Stainless steel finish	Amok Picopass	227,00
KPB07IPA7	Polished stainless steel finish	Amok Picopass	252,15
KPB07IMA8	Stainless steel finish	Amok LEGIC Advant	213,65
KPB07IPA8	Polished stainless steel finish	Amok LEGIC Advant	237,35
KPB07IMA9	Stainless steel finish	Amok Mifare DESFire	213,65
KPB07IPA9	Polished stainless steel finish	Amok Mifare DESFire	237,35
KPB07IMAH	Stainless steel finish	Amok HID iCLASS	249,10
KPB07IPAH	Polished stainless steel finish	Amok HID iCLASS	276,75

Panic Bar	Mortise Lock Needed	Mortise Lock Drawing	Escutcheon Needed	Note
Vachette 6720 Vachette 6730 Vachette 6740 Vachette 6750 (Multi ponits)			Ei650m00ffH8 Ei660m00ffH8 Ei6E0m00ffH8 Ei6P0m00ffH8	Wireless Possible

KPB08

SALTO XS4 Panic Bar Kit for versions of SARGENT.

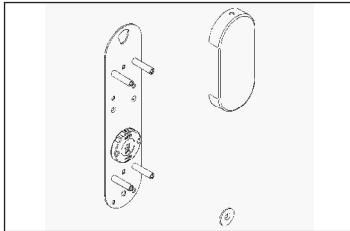

Prices - Gross prices

€

Product	Finish	Offline stand alone or Wireless online	
KPB08IM	Stainless steel finish	Offline stand alone	164,00
KPB08IP	Polished stainless steel finish	Offline stand alone	182,75
KPB08IMW	Stainless steel finish	Wireless online	286,70
KPB08IPW	Polished stainless steel finish	Wireless online	304,80
KPB08IMA7	Stainless steel finish	Amok Picopass	221,10
KPB08IPA7	Polished stainless steel finish	Amok Picopass	246,40
KPB08IMA8	Stainless steel finish	Amok LEGIC Advant	208,20
KPB08IPA8	Polished stainless steel finish	Amok LEGIC Advant	231,95
KPB08IMA9	Stainless steel finish	Amok Mifare DESFire	208,20
KPB08IPA9	Polished stainless steel finish	Amok Mifare DESFire	231,95
KPB08IMAH	Stainless steel finish	Amok HID iCLASS	242,65
KPB08IPAH	Polished stainless steel finish	Amok HID iCLASS	270,45



Wireless version available - no inside handle opening detection.

Panic Bar	Mortise Lock Needed	Mortise Lock Drawing	Escutcheon Needed	Note
Sargent 8800 (Single Point)			Ai650m00ffH8 Ai660m00ffH8	Opening from the inside detection not possible

KPB10

SALTO XS4 Panic Bar Kit for versions of NINZ.

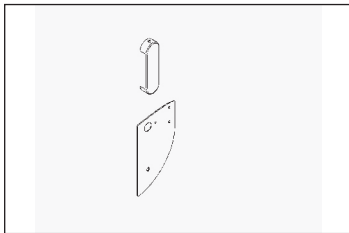

Prices - Gross prices			€
Product	Finish	Offline stand alone or Wireless online	
KPB10IM	Stainless steel finish	Offline stand alone	117,95
KPB10IP	Polished stainless steel finish	Offline stand alone	136,60
KPB10IMW	Stainless steel finish	Wireless online	240,65
KPB10IPW	Polished stainless steel finish	Wireless online	259,30
KPB10IMA7	Stainless steel finish	Amok Picopass	159,00
KPB10IPA7	Polished stainless steel finish	Amok Picopass	184,20
KPB10IMA8	Stainless steel finish	Amok LEGIC Advant	149,65
KPB10IPA8	Polished stainless steel finish	Amok LEGIC Advant	173,45
KPB10IMA9	Stainless steel finish	Amok Mifare DESFire	149,65
KPB10IPA9	Polished stainless steel finish	Amok Mifare DESFire	173,45
KPB10IMAH	Stainless steel finish	Amok HID iCLASS	174,55
KPB10IPAH	Polished stainless steel finish	Amok HID iCLASS	202,15

Panic Bar	Mortise Lock Needed	Mortise Lock Drawing	Escutcheon Needed	Note
NINZ SLASH (Mortice Lock)	DIN 18250 72PZ		Ei450m7FffH9 Ei454m7FffH9 Ei460m7FffH9 Ei650m7FffH9 Ei654m7FffH9 Ei6E0m7FffH9	Wireless Possible (Except Split Spindle) Only 7F Models
	Type RF fire 72 PZ		Ei450m7FffH9 Ei454m7FffH9 Ei460m7FffH9 Ei650m7FffH9 Ei654m7FffH9 Ei6E0m7FffH9	Wireless Possible (Except Split Spindle) Only 7F Models
	Metal frame 92 PZ		Ei450m7FffH9 Ei460m7FffH9	Wireless Possible (Except Split Spindle) Only 7F Models

KPB11

SALTO XS4 Panic Bar Kit for versions of TESA and Hnos Padilla T Series.

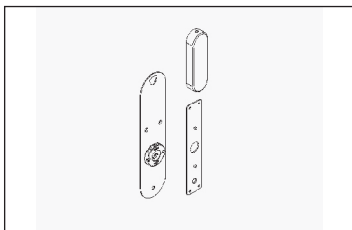

Prices - Gross prices			€
Product	Finish	Offline stand alone or Wireless online	
KPB11IM	Stainless steel finish	Offline stand alone	149,55
KPB11IP	Polished stainless steel finish	Offline stand alone	168,30
KPB11IMW	Stainless steel finish	Wireless online	272,30
KPB11IPW	Polished stainless steel finish	Wireless online	290,50
KPB11IMA7	Stainless steel finish	Amok Picopass	201,70
KPB11IPA7	Polished stainless steel finish	Amok Picopass	227,00
KPB11IMA8	Stainless steel finish	Amok LEGIC Advant	189,90
KPB11IPA8	Polished stainless steel finish	Amok LEGIC Advant	213,65
KPB11IMA9	Stainless steel finish	Amok Mifare DESFire	189,90
KPB11IPA9	Polished stainless steel finish	Amok Mifare DESFire	213,65
KPB11IMAH	Stainless steel finish	Amok HID iCLASS	221,30
KPB11IPAH	Polished stainless steel finish	Amok HID iCLASS	249,10

Panic Bar	Mortise Lock Needed	MortiseLock Drawing	Escutcheon Needed	Note
TESA 1910 (Single Point)			Ai650m00ffH8 Ai660m00ffH8	Opening from the inside detection not possible



Wireless version available - no inside handle opening detection.

KPB12

SALTO XS4 Panic Bar Kit for versions of TESA and Hnos Padilla 950-52-53 Series .

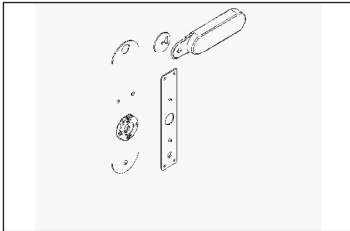

Prices - Gross prices			€
Product	Finish	Offline stand alone or Wireless online	
KPB12IM	Stainless steel finish	Offline stand alone	168,30
KPB12IP	Polished stainless steel finish	Offline stand alone	186,95
KPB12IMW	Stainless steel finish	Wireless online	291,05
KPB12IPW	Polished stainless steel finish	Wireless online	309,15
KPB12IMA7	Stainless steel finish	Amok Picopass	227,00
KPB12IPA7	Polished stainless steel finish	Amok Picopass	252,15
KPB12IMA8	Stainless steel finish	Amok LEGIC Advant	213,65
KPB12IPA8	Polished stainless steel finish	Amok LEGIC Advant	237,35
KPB12IMA9	Stainless steel finish	Amok Mifare DESFire	213,65
KPB12IPA9	Polished stainless steel finish	Amok Mifare DESFire	237,35
KPB12IMAH	Stainless steel finish	Amok HID iCLASS	249,10
KPB12IPAH	Polished stainless steel finish	Amok HID iCLASS	276,75

Panic Bar	Mortise Lock Needed	Mortise Lock Drawing	Escutcheon Needed	Note
TESA 1920 TESA 1930 TESA 1950 TESA 195L (Single Point)			Ai650m00ffH8 Ai660m00ffH8	Opening from the inside detection not possible



Wireless version available - no inside handle opening detection.

KPB13

SALTO XS4 Panic Bar Kit for versions of TESA and Hnos Padilla SR Series.

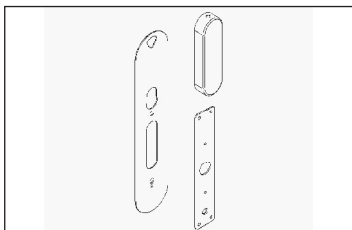

Prices - Gross prices			€
Product	Finish	Offline stand alone or Wireless online	
KPB13IM	Stainless steel finish	Offline stand alone	125,15
KPB13IP	Polished stainless steel finish	Offline stand alone	143,85
KPB13IMW	Stainless steel finish	Wireless online	247,80
KPB13IPW	Polished stainless steel finish	Wireless online	266,55
KPB13IMA7	Stainless steel finish	Amok Picopass	168,75
KPB13IPA7	Polished stainless steel finish	Amok Picopass	193,90
KPB13IMA8	Stainless steel finish	Amok LEGIC Advant	158,80
KPB13IPA8	Polished stainless steel finish	Amok LEGIC Advant	182,60
KPB13IMA9	Stainless steel finish	Amok Mifare DESFire	158,80
KPB13IPA9	Polished stainless steel finish	Amok Mifare DESFire	182,60
KPB13IMAH	Stainless steel finish	Amok HID iCLASS	185,25
KPB13IPAH	Polished stainless steel finish	Amok HID iCLASS	212,85

Panic Bar	Mortise Lock needed	Mortise Lock Drawing	Escutcheon Needed	Note
TESA 1970 (Mortise Lock)	DIN 18250 72 PZ		Ai650m00ff-Hx Ai660m00ff-Hx	Wireless Possible (Except Split Spindle) Spindle x = 8 or 9 only
	European Mortise Lock 85 PZ		Ai650m00ff-Hx Ai660m00ff-Hx	Wireless Possible (Except Split Spindle) Spindle x = 8 or 9 only
	Type RF fire 72 PZ		Ai650m00ff-Hx Ai660m00ff-Hx	Wireless Possible (Except Split Spindle) Spindle x = 8 or 9 only

KPB14

SALTO XS4 Panic Bar Kit for versions of DORMA.

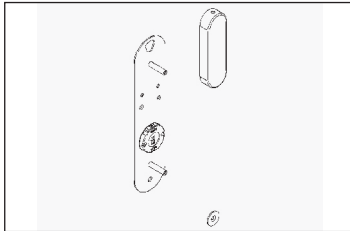

Prices - Gross prices			€
Product	Finish	Offline stand alone or Wireless online	
KPB14IM	Stainless steel finish	Offline stand alone	153,95
KPB14IP	Polished stainless steel finish	Offline stand alone	172,60
KPB14IMW	Stainless steel finish	Wireless online	276,70
KPB14IPW	Polished stainless steel finish	Wireless online	294,80
KPB14IMA7	Stainless steel finish	Amok Picopass	207,45
KPB14IPA7	Polished stainless steel finish	Amok Picopass	232,70
KPB14IMA8	Stainless steel finish	Amok LEGIC Advant	195,35
KPB14IPA8	Polished stainless steel finish	Amok LEGIC Advant	219,05
KPB14IMA9	Stainless steel finish	Amok Mifare DESFire	195,35
KPB14IPA9	Polished stainless steel finish	Amok Mifare DESFire	219,05
KPB14IMAH	Stainless steel finish	Amok HID iCLASS	227,80
KPB14IPAH	Polished stainless steel finish	Amok HID iCLASS	255,40

Panic Bar	Mortise Lock Needed	Mortise Lock Drawing	Escutcheon Needed	Note
DORMA AD4300 (Single Point)			Ai650m00ffH8 Ai660m00ffH8	Opening from the inside detection not possible



Wireless version available - no inside handle opening detection.

KPB15

SALTO XS4 Panic Bar Kit for versions of DORMA.



Prices - Gross prices			€
Product	Finish	Offline stand alone or Wireless online	
KPB15IM	Stainless steel finish	Offline stand alone	172,60
KPB15IP	Polished stainless steel finish	Offline stand alone	191,35
KPB15IMW	Stainless steel finish	Wireless online	295,40
KPB15IPW	Polished stainless steel finish	Wireless online	313,50
KPB15IMA7	Stainless steel finish	Amok Picopass	232,70
KPB15IPA7	Polished stainless steel finish	Amok Picopass	258,05
KPB15IMA8	Stainless steel finish	Amok LEGIC Advant	219,05
KPB15IPA8	Polished stainless steel finish	Amok LEGIC Advant	242,90
KPB15IMA9	Stainless steel finish	Amok Mifare DESFire	219,05
KPB15IPA9	Polished stainless steel finish	Amok Mifare DESFire	242,90
KPB15IMAH	Stainless steel finish	Amok HID iCLASS	255,40
KPB15IPAH	Polished stainless steel finish	Amok HID iCLASS	283,15

Panic Bar	Mortise Lock Needed	Mortise Lock Drawing	Escutcheon Needed	Note
DORMA AD4400 (Two Locking points)			Ai650m00ffH8 Ai660m00ffH8	Opening from the inside detection not possible



Wireless version available - no inside handle opening detection.

KPB16

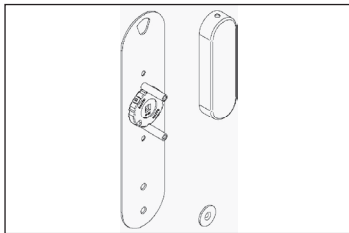

SALTO XS4 Panic Bar Kit for versions of DORMA PHA2100, FAPIM PANAMA 8010, ISEO IDEA 941 1, ISEO PUSH BAR 944 1.



Prices - Gross prices			€
Product	Finish	Offline stand alone or Wireless online	
KPB16IM	Stainless steel finish	Offline stand alone	168,80
KPB16IP	Polished stainless steel finish	Offline stand alone	187,45
KPB16IMW	Stainless steel finish	Wireless online	291,45
KPB16IPW	Polished stainless steel finish	Wireless online	309,60
KPB16IMA7	Stainless steel finish	Amok Picopass	227,60
KPB16IPA7	Polished stainless steel finish	Amok Picopass	252,70
KPB16IMA8	Stainless steel finish	Amok LEGIC Advant	214,25
KPB16IPA8	Polished stainless steel finish	Amok LEGIC Advant	237,90
KPB16IMA9	Stainless steel finish	Amok Mifare DESFire	214,25
KPB16IPA9	Polished stainless steel finish	Amok Mifare DESFire	237,90
KPB16IMAH	Stainless steel finish	Amok HID iCLASS	249,85
KPB16IPAH	Polished stainless steel finish	Amok HID iCLASS	277,35



Wireless version available - no inside handle opening detection.

Panic Bar	Mortise Lock Needed	Mortise Lock Drawing	Escutcheon Needed	Note
DORMA PHA2100			Ei650m00ffH8 Ei660m00ffH8 Ei6E0m00ffH8 Ei6P0m00ffH8	Opening from the inside detection not possible
FAPIM PANAMA 8010			Ei650m00ffH8 Ei660m00ffH8 Ei6E0m00ffH8 Ei6P0m00ffH8	
ISEO IDEA 941 1			Ei650m00ffH8 Ei660m00ffH8 Ei6E0m00ffH8 Ei6P0m00ffH8	
ISEO PUSH BAR 944 1			Ei650m00ffH8 Ei660m00ffH8 Ei6E0m00ffH8 Ei6P0m00ffH8	

KPB17

SALTO XS4 Panic Bar Kit for versions of CORBIN RUSSWIN ED5200, YALE 7100.

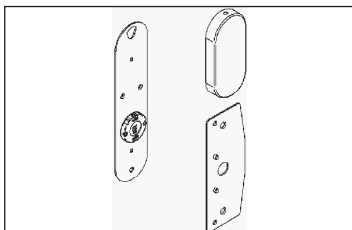

Prices - Gross prices			€
Product	Finish	Offline stand alone or Wireless online	
KPB17IM	Stainless steel finish	Offline stand alone	191,45
KPB17IP	Polished stainless steel finish	Offline stand alone	210,10
KPB17IMW	Stainless steel finish	Wireless online	314,15
KPB17IPW	Polished stainless steel finish	Wireless online	332,30
KPB17IMA7	Stainless steel finish	Amok Picopass	258,15
KPB17IPA7	Polished stainless steel finish	Amok Picopass	283,20
KPB17IMA8	Stainless steel finish	Amok LEGIC Advant	243,05
KPB17IPA8	Polished stainless steel finish	Amok LEGIC Advant	266,65
KPB17IMA9	Stainless steel finish	Amok Mifare DESFire	243,05
KPB17IPA9	Polished stainless steel finish	Amok Mifare DESFire	266,65
KPB17IMAH	Stainless steel finish	Amok HID iCLASS	283,30
KPB17IPAH	Polished stainless steel finish	Amok HID iCLASS	310,90

Panic Bar	Mortise Lock Needed	Mortise Lock Drawing	Escutcheon Needed	Note
CORBIN RUSSWIN ED5200 (Single point)			Ai650m00ffH8 Ai660m00ffH8	Opening from the inside detection not possible
YALE 7100 (Single point)			Ai650m00ffH8 Ai660m00ffH8	



Wireless version available - no inside handle opening detection.

KPB18

SALTO XS4 Panic Bar Kit for versions of FALCON MONARCH 18.

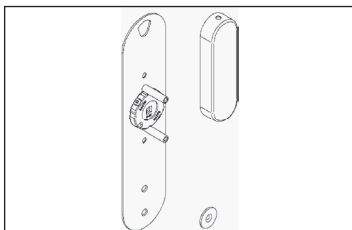

Prices - Gross prices			€
Product	Finish	Offline stand alone or Wireless online	
KPB18IM	Stainless steel finish	Offline stand alone	172,70
KPB18IP	Polished stainless steel finish	Offline stand alone	191,45
KPB18IMW	Stainless steel finish	Wireless online	295,50
KPB18IPW	Polished stainless steel finish	Wireless online	313,60
KPB18IMA7	Stainless steel finish	Amok Picopass	232,80
KPB18IPA7	Polished stainless steel finish	Amok Picopass	258,15
KPB18IMA8	Stainless steel finish	Amok LEGIC Advant	219,15
KPB18IPA8	Polished stainless steel finish	Amok LEGIC Advant	243,05
KPB18IMA9	Stainless steel finish	Amok Mifare DESFire	219,15
KPB18IPA9	Polished stainless steel finish	Amok Mifare DESFire	243,05
KPB18IMAH	Stainless steel finish	Amok HID iCLASS	255,55
KPB18IPAH	Polished stainless steel finish	Amok HID iCLASS	283,30

Panic Bar	Mortise Lock Needed	Mortise Lock Drawing	Escutcheon Needed	Note
FALCON MONARCH 18 (Single point)			Si650m00ffH8	Opening from the inside detection not possible



Wireless version available - no inside handle opening detection.

KPB19

SALTO XS4 Panic Bar Kit for versions of DORMA.

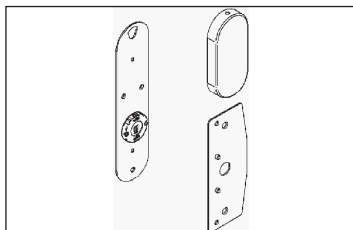

Prices - Gross prices			€
Product	Finish	Offline stand alone or Wireless online	
KPB19IM	Stainless steel finish	Offline stand alone	198,15
KPB19IP	Polished stainless steel finish	Offline stand alone	216,80
KPB19IMW	Stainless steel finish	Wireless online	320,90
KPB19IPW	Polished stainless steel finish	Wireless online	339,00
KPB19IMA7	Stainless steel finish	Amok Picopass	267,20
KPB19IPA7	Polished stainless steel finish	Amok Picopass	292,45
KPB19IMA8	Stainless steel finish	Amok LEGIC Advant	251,55
KPB19IPA8	Polished stainless steel finish	Amok LEGIC Advant	275,20
KPB19IMA9	Stainless steel finish	Amok Mifare DESFire	251,55
KPB19IPA9	Polished stainless steel finish	Amok Mifare DESFire	275,20
KPB19IMAH	Stainless steel finish	Amok HID iCLASS	293,30
KPB19IPAH	Polished stainless steel finish	Amok HID iCLASS	320,90

Panic Bar	Mortise Lock Needed	Mortise Lock Drawing	Escutcheon Needed	Note
DORMA 9300 (Single point)			Ai650m00ffH8 Ai660m00ffH8	Opening from the inside detection not possible



Wireless version available - no inside handle opening detection.

KPB20

SALTO XS4 Panic Bar Kit for versions of CISA 59000.

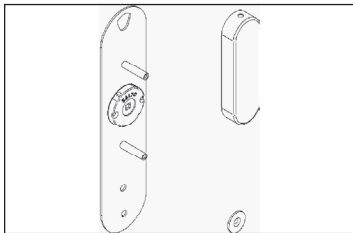

Prices - Gross prices			€
Product	Finish	Offline stand alone or Wireless online	
KPB20IM	Stainless steel finish	Offline stand alone	157,15
KPB20IP	Polished stainless steel finish	Offline stand alone	175,75
KPB20IMW	Stainless steel finish	Wireless online	279,80
KPB20IPW	Polished stainless steel finish	Wireless online	297,95
KPB20IMA7	Stainless steel finish	Amok Picopass	211,85
KPB20IPA7	Polished stainless steel finish	Amok Picopass	237,00
KPB20IMA8	Stainless steel finish	Amok LEGIC Advant	199,45
KPB20IPA8	Polished stainless steel finish	Amok LEGIC Advant	223,10
KPB20IMA9	Stainless steel finish	Amok Mifare DESFire	199,45
KPB20IPA9	Polished stainless steel finish	Amok Mifare DESFire	223,10
KPB20IMAH	Stainless steel finish	Amok HID iCLASS	232,50
KPB20IPAH	Polished stainless steel finish	Amok HID iCLASS	260,15

Panic Bar	Mortise Lock Needed	Mortise Lock Drawing	Escutcheon Needed	Note
CISA 59000 (Single point)			Ei650m00ffH7 Ei660m00ffH7 Ei6E0m00ffH7 Ei6P0m00ffH7	Opening from the inside detection not possible



Wireless version available - no inside handle opening detection.

KPB21

SALTO XS4 Panic Bar Kit for versions of CISA 59010-15.

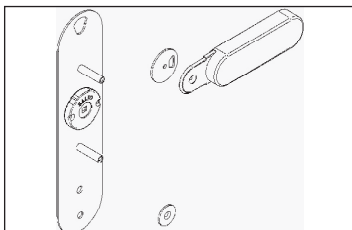

Prices - Gross prices			€
Product	Finish	Offline stand alone or Wireless online	
KPB21IM	Stainless steel finish	Offline stand alone	177,05
KPB21IP	Polished stainless steel finish	Offline stand alone	195,65
KPB21IMW	Stainless steel finish	Wireless online	299,80
KPB21IPW	Polished stainless steel finish	Wireless online	317,90
KPB21IMA7	Stainless steel finish	Amok Picopass	238,80
KPB21IPA7	Polished stainless steel finish	Amok Picopass	263,85
KPB21IMA8	Stainless steel finish	Amok LEGIC Advant	224,80
KPB21IPA8	Polished stainless steel finish	Amok LEGIC Advant	248,40
KPB21IMA9	Stainless steel finish	Amok Mifare DESFire	224,80
KPB21IPA9	Polished stainless steel finish	Amok Mifare DESFire	248,40
KPB21IMAH	Stainless steel finish	Amok HID iCLASS	262,00
KPB21IPAH	Polished stainless steel finish	Amok HID iCLASS	289,65

Panic Bar	Mortise Lock Needed	Mortise Lock Drawing	Escutcheon Needed	Note
CISA 59010-15 (Multipoint)			Ei650m00ffH7 Ei660m00ffH7 Ei6E0m00ffH7 Ei6P0m00ffH7	Opening from the inside detection not possible



Wireless version available - no inside handle opening detection.

KPB22

SALTO XS4 Panic Bar Kit for versions of CISA 59800.

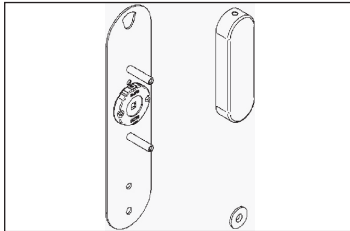

Prices - Gross prices			€
Product	Finish	Offline stand alone or Wireless online	
KPB22IM	Stainless steel finish	Offline stand alone	157,70
KPB22IP	Polished stainless steel finish	Offline stand alone	176,40
KPB22IMW	Stainless steel finish	Wireless online	280,40
KPB22IPW	Polished stainless steel finish	Wireless online	298,65
KPB22IMA7	Stainless steel finish	Amok Picopass	212,70
KPB22IPA7	Polished stainless steel finish	Amok Picopass	237,85
KPB22IMA8	Stainless steel finish	Amok LEGIC Advant	200,20
KPB22IPA8	Polished stainless steel finish	Amok LEGIC Advant	223,90
KPB22IMA9	Stainless steel finish	Amok Mifare DESFire	200,20
KPB22IPA9	Polished stainless steel finish	Amok Mifare DESFire	223,90
KPB22IMAH	Stainless steel finish	Amok HID iCLASS	233,40
KPB22IPAH	Polished stainless steel finish	Amok HID iCLASS	261,00

Panic Bar	Mortise Lock Needed	Mortise Lock Drawing	Escutcheon Needed	Note
CISA 59800 (Single point)			Ei650m00ffH7 Ei660m00ffH7 Ei6E0m00ffH7 Ei6P0m00ffH7	Opening from the inside detection not possible



Wireless version available - no inside handle opening detection.

KPB23

SALTO XS4 Panic Bar Kit for versions of CISA 58010-15.

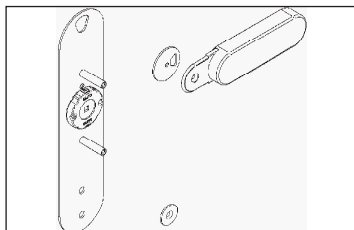

Prices - Gross prices			€
Product	Finish	Offline stand alone or Wireless online	
KPB23IM	Stainless steel finish	Offline stand alone	177,40
KPB23IP	Polished stainless steel finish	Offline stand alone	196,10
KPB23IMW	Stainless steel finish	Wireless online	300,10
KPB23IPW	Polished stainless steel finish	Wireless online	318,35
KPB23IMA7	Stainless steel finish	Amok Picopass	239,20
KPB23IPA7	Polished stainless steel finish	Amok Picopass	264,30
KPB23IMA8	Stainless steel finish	Amok LEGIC Advant	225,20
KPB23IPA8	Polished stainless steel finish	Amok LEGIC Advant	248,90
KPB23IMA9	Stainless steel finish	Amok Mifare DESFire	225,20
KPB23IPA9	Polished stainless steel finish	Amok Mifare DESFire	248,90
KPB23IMAH	Stainless steel finish	Amok HID iCLASS	262,60
KPB23IPAH	Polished stainless steel finish	Amok HID iCLASS	290,20

Panic Bar	Mortise Lock Needed	Mortise Lock Drawing	Escutcheon Needed	Note
CISA 58010-15 (Multipoint)			Ei650m00ffH7 Ei660m00ffH7 Ei6E0m00ffH7 Ei6P0m00ffH7	Opening from the inside detection not possible



Wireless version available - no inside handle opening detection.

KPB24

SALTO XS4 Panic Bar Kit for versions of CAL ROYAL.

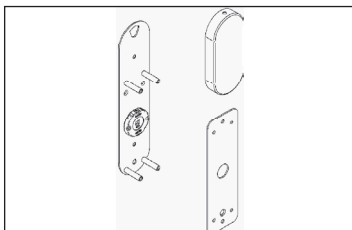

Prices - Gross prices			€
Product	Finish	Offline stand alone or Wireless online	
KPB24IM	Stainless steel finish	Offline stand alone	204,35
KPB24IP	Polished stainless steel finish	Offline stand alone	223,10
KPB24IMW	Stainless steel finish	Wireless online	327,10
KPB24IPW	Polished stainless steel finish	Wireless online	345,25
KPB24IMA7	Stainless steel finish	Amok Picopass	275,45
KPB24IPA7	Polished stainless steel finish	Amok Picopass	300,85
KPB24IMA8	Stainless steel finish	Amok LEGIC Advant	259,35
KPB24IPA8	Polished stainless steel finish	Amok LEGIC Advant	283,10
KPB24IMA9	Stainless steel finish	Amok Mifare DESFire	259,35
KPB24IPA9	Polished stainless steel finish	Amok Mifare DESFire	283,10
KPB24IMAH	Stainless steel finish	Amok HID iCLASS	302,35
KPB24IPAH	Polished stainless steel finish	Amok HID iCLASS	330,05

Panic Bar	Mortise Lock Needed	Mortise Lock Drawing	Escutcheon Needed	Note
CAL ROYAL 9800 (Single point)			Ai650m00ffH8 Ai660m00ffH8	Opening from the inside detection not possible



Wireless version available - no inside handle opening detection.

KPB25

SALTO XS4 Panic Bar Kit for versions of ASSA 810701.

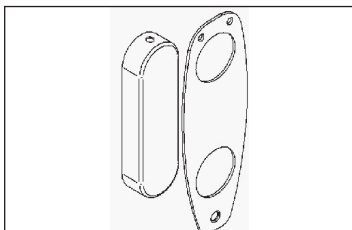

Prices - Gross prices			€
Product	Finish	Offline stand alone or Wireless online	
KPB25IM	Stainless steel finish	Offline stand alone	118,30
KPB25IP	Polished stainless steel finish	Offline stand alone	136,85
KPB25IMW	Stainless steel finish	Wireless online	241,00
KPB25IPW	Polished stainless steel finish	Wireless online	259,10
KPB25IMA7	Stainless steel finish	Amok Picopass	159,50
KPB25IPA7	Polished stainless steel finish	Amok Picopass	184,55
KPB25IMA8	Stainless steel finish	Amok LEGIC Advant	150,10
KPB25IPA8	Polished stainless steel finish	Amok LEGIC Advant	173,75
KPB25IMA9	Stainless steel finish	Amok Mifare DESFire	150,10
KPB25IPA9	Polished stainless steel finish	Amok Mifare DESFire	173,75
KPB25IMAH	Stainless steel finish	Amok HID iCLASS	175,00
KPB25IPAH	Polished stainless steel finish	Amok HID iCLASS	202,55

Panic Bar	Mortise Lock Needed	Mortise Lock Drawing	Escutcheon Needed	Note
ASSA 810701	ASSA 1525 / 1526		Si450m00ffH8 Si454m05ffH8 Si650m00ffH8 Si654m05ffH8	Opening from the inside detection not possible



Wireless version available - no inside handle opening detection.

KPB26

SALTO XS4 Panic Bar Kit for versions of CISA 59616, 59710.

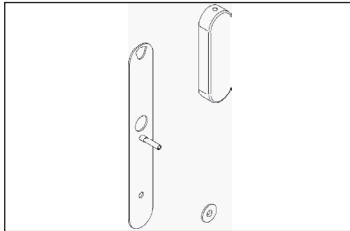

Prices - Gross prices			€
Product	Finish	Offline stand alone or Wireless online	
KPB26IM	Stainless steel finish	Offline stand alone	126,30
KPB26IP	Polished stainless steel finish	Offline stand alone	144,85
KPB26IMW	Stainless steel finish	Wireless online	248,95
KPB26IPW	Polished stainless steel finish	Wireless online	267,75
KPB26IMA7	Stainless steel finish	Amok Picopass	170,30
KPB26IPA7	Polished stainless steel finish	Amok Picopass	195,40
KPB26IMA8	Stainless steel finish	Amok LEGIC Advant	160,35
KPB26IPA8	Polished stainless steel finish	Amok LEGIC Advant	184,00
KPB26IMA9	Stainless steel finish	Amok Mifare DESFire	160,35
KPB26IPA9	Polished stainless steel finish	Amok Mifare DESFire	184,00
KPB26IMAH	Stainless steel finish	Amok HID iCLASS	186,90
KPB26IPAH	Polished stainless steel finish	Amok HID iCLASS	214,45

Panic Bar	Mortise Lock Needed	Mortise Lock Drawing	Escutcheon Needed	Note
CISA 59616	DIN 18250 72 PZ		Ei450m7FffH9 Ei454m7FffH9 Ei460m7FffH9	Wireless Possible (Except Split Spindle) Only 7F Models
	Type RF fire 72 PZ		Ei450m7FffH9 Ei454m7FffH9 Ei460m7FffH9	Wireless Possible (Except Split Spindle) Only 7F Models
	Metal frame 92 PZ		Ei450m00ffH9 Ei460m00ffH9	Wireless Possible (Except Split Spindle)
CISA 59710	DIN 18250 72 PZ		Ei450m00ffH9 Ei454m72ffH9 Ei460m00ffH9 Ei4P0m00ffH9	Wireless Possible (Except Split Spindle)
	Type RF fire 72 PZ		Ei450m7FffH9 Ei454m7FffH9 Ei460m7FffH9	Wireless Possible (Except Split Spindle) Only 7F Models
	Metal frame 92 PZ		Ei450m00ffH9 Ei454m00ffH9 Ei460m00ffH9 Ei4P0m00ffH9	Wireless Possible (Except Split Spindle)

KPB27

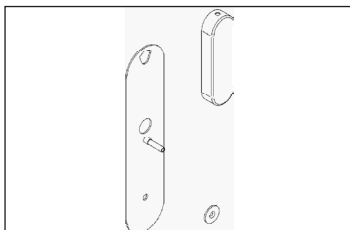

SALTO XS4 Panic Bar Kit for versions of CISA 59616, 59710.



Prices - Gross prices			€
Product	Finish	Offline stand alone or Wireless online	
KPB27IM	Stainless steel finish	Offline stand alone	132,00
KPB27IP	Polished stainless steel finish	Offline stand alone	150,55
KPB27IMW	Stainless steel finish	Wireless online	254,65
KPB27IPW	Polished stainless steel finish	Wireless online	273,35
KPB27IMA7	Stainless steel finish	Amok Picopass	177,85
KPB27IPA7	Polished stainless steel finish	Amok Picopass	203,00
KPB27IMA8	Stainless steel finish	Amok LEGIC Advant	167,45
KPB27IPA8	Polished stainless steel finish	Amok LEGIC Advant	191,15
KPB27IMA9	Stainless steel finish	Amok Mifare DESFire	167,45
KPB27IPA9	Polished stainless steel finish	Amok Mifare DESFire	191,15
KPB27IMAH	Stainless steel finish	Amok HID iCLASS	195,15
KPB27IPAH	Polished stainless steel finish	Amok HID iCLASS	222,85

Panic Bar	Mortise Lock Needed	Mortise Lock Drawing	Escutcheon Needed	Note
CISA 59616	DIN 18250 72 PZ		Ei650m7FffH9 Ei654m7FffH9 Ei6E0m7FffH9	Wireless Possible (Except Split Spindle) Only 7F Models
	Type RF fire 72 PZ		Ei650m7FffH9 E654m7FffH9 Ei6E0m7FffH9	Wireless Possible (Except Split Spindle) Only 7F Models
	Metal frame 92 PZ		Ei650m00ffH9 Ei6E0m00ffH9	Wireless Possible (Except Split Spindle) Only 7F Models
CISA 59710	DIN 18250 72 PZ		Ei650m00ffH9 Ei654m72ffH9 Ei660m00ffH9 Ei6P0m00ffH9 Ei6E0m00ffH9	Wireless Possible (Except Split Spindle)
	Type RF fire 72 PZ		Ei650m7FffH9 Ei654m7FffH9 Ei6E0m7FffH9	Wireless Possible (Except Split Spindle) Only 7F Models

KPB28

SALTO XS4 Panic Bar Kit for versions of TINKO 5500.

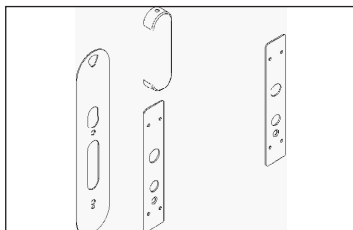

Prices - Gross prices			€
Product	Finish	Offline stand alone or Wireless online	
KPB28IM	Stainless steel finish	Offline stand alone	156,25
KPB28IP	Polished stainless steel finish	Offline stand alone	175,00
KPB28IMW	Stainless steel finish	Wireless online	279,05
KPB28IPW	Polished stainless steel finish	Wireless online	297,60
KPB28IMA7	Stainless steel finish	Amok Picopass	210,70
KPB28IPA7	Polished stainless steel finish	Amok Picopass	236,00
KPB28IMA8	Stainless steel finish	Amok LEGIC Advant	198,30
KPB28IPA8	Polished stainless steel finish	Amok LEGIC Advant	222,20
KPB28IMA9	Stainless steel finish	Amok Mifare DESFire	198,30
KPB28IPA9	Polished stainless steel finish	Amok Mifare DESFire	222,20
KPB28IMAH	Stainless steel finish	Amok HID iCLASS	231,20
KPB28IPAH	Polished stainless steel finish	Amok HID iCLASS	258,90

Panic Bar	Mortise Lock Needed	Mortise Lock Drawing	Escutcheon Needed	Note
TINKO 5500	DIN 18250 72 PZ		Ai650m00ffHx Ai660m00ffHx	Wireless Possible (Except Split Spindle) Spindle x = 8 or 9 only
	Europe Mortise lock 85PZ		Ai650m00ffHx Ai660m00ffHx	Wireless Possible (Except Split Spindle) Spindle x = 8 or 9 only
	Type RF fire 72 PZ		Ai650m00ffHx Ai660m00ffHx	Wireless Possible (Except Split Spindle) Spindle x = 8 or 9 only

KPB29

SALTO XS4 Panic Bar Kit for versions of SÖDERHAMN INNOVATION NÖ-DÖPPNARE Typ P

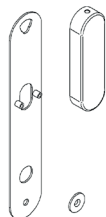

Prices - Gross prices			€
Product	Finish	Offline stand alone or Wireless online	
KPB29IM	Stainless steel finish	Offline stand alone	274,80
KPB29IP	Polished stainless steel finish	Offline stand alone	316,10
KPB29IMW	Stainless steel finish	Wireless online	397,70
KPB29IPW	Polished stainless steel finish	Wireless online	438,85
KPB29IMA7	Stainless steel finish	Amok Picopass	370,55
KPB29IPA7	Polished stainless steel finish	Amok Picopass	426,30
KPB29IMA8	Stainless steel finish	Amok LEGIC Advant	348,85
KPB29IPA8	Polished stainless steel finish	Amok LEGIC Advant	401,35
KPB29IMA9	Stainless steel finish	Amok Mifare DESFire	348,85
KPB29IPA9	Polished stainless steel finish	Amok Mifare DESFire	401,35
KPB29IMAH	Stainless steel finish	Amok HID iCLASS	406,75
KPB29IPAH	Polished stainless steel finish	Amok HID iCLASS	467,80

Panic Bar	Mortise Lock Needed	Mortise Lock Drawing	Escutcheon Needed	Note
SÖDERHAMN INNOVATION NÖDÖPPNARE Typ P	ASSA 560/562 1560/8561		Si450m00ffH8 Si454m05ffH8	Wireless Possible (Except Split Spindle)

KPB30

SALTO XS4 Panic Bar Kit for versions of ANTIPANIC601

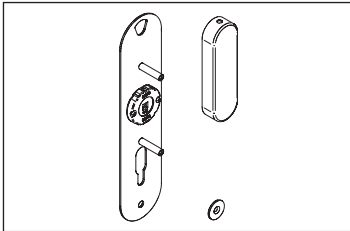

Prices - Gross prices			€
Product	Finish	Offline stand alone or Wireless online	
KPB30IM	Stainless steel finish	Offline stand alone	153,95
KPB30IP	Polished stainless steel finish	Offline stand alone	278,70
KPB30IMW	Stainless steel finish	Wireless online	172,60
KPB30IPW	Polished stainless steel finish	Wireless online	297,05
KPB30IMA7	Stainless steel finish	Amok Picopass	207,45
KPB30IPA7	Polished stainless steel finish	Amok Picopass	375,70
KPB30IMA8	Stainless steel finish	Amok LEGIC Advant	195,35
KPB30IPA8	Polished stainless steel finish	Amok LEGIC Advant	353,75
KPB30IMA9	Stainless steel finish	Amok Mifare DESFire	195,35
KPB30IPA9	Polished stainless steel finish	Amok Mifare DESFire	353,75
KPB30IMAH	Stainless steel finish	Amok HID iCLASS	227,80
KPB30IPAH	Polished stainless steel finish	Amok HID iCLASS	412,45

Panic Bar	Mortise Lock Needed	Mortise Lock Drawing	Escutcheon Needed	Note
ANTIPANIC 601 (Single Point)			Ei650m00ffH8 Ei660m00ffH8 Ei6E0m00ffH8 Ei6P0m00ffH8	Opening from the inside detection not possible



Wireless version available - no inside handle opening detection.

KPB31

SALTO XS4 Panic Bar Kit for versions of TESA TEMPRO TM1

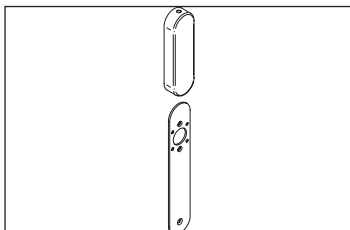

Prices - Gross prices			€
Product	Finish	Offline stand alone or Wireless online	
KPB31IM	Stainless steel finish	Offline stand alone	117,95
KPB31IP	Polished stainless steel finish	Offline stand alone	136,60
KPB31IMW	Stainless steel finish	Wireless online	240,65
KPB31IPW	Polished stainless steel finish	Wireless online	259,30
KPB31IMA7	Stainless steel finish	Amok Picopass	159,00
KPB31IPA7	Polished stainless steel finish	Amok Picopass	184,20
KPB31IMA8	Stainless steel finish	Amok LEGIC Advant	149,65
KPB31IPA8	Polished stainless steel finish	Amok LEGIC Advant	173,45
KPB31IMA9	Stainless steel finish	Amok Mifare DESFire	149,65
KPB31IPA9	Polished stainless steel finish	Amok Mifare DESFire	173,45
KPB31IMAH	Stainless steel finish	Amok HID iCLASS	174,55
KPB31IPAH	Polished stainless steel finish	Amok HID iCLASS	202,15

Panic Bar	Mortise Lock Needed	Mortise Lock Drawing	Escutcheon Needed	Note
TESA TEMPRO TM1	TESA 2035T/4039T 85 PZ		Ei450m00ffH8 Ei454m85ffH8 Ei460m00ffH8 Ei4P0m00ffH8 Ei650m00ffH8 Ei654m85ffH9 Ei660m00ffH8 Ei6E0m00ffH8 Ei6P0m00ffH8	Wireless Possible (Except Split Spindle)

KPB32

SALTO XS4 Panic Bar Kit for versions of TESA TEMPRO TM1

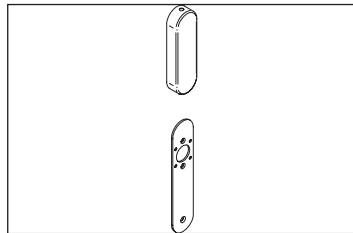

Prices - Gross prices			€
Product	Finish	Offline stand alone or Wireless online	
KPB32IM	Stainless steel finish	Offline stand alone	117,95
KPB32IP	Polished stainless steel finish	Offline stand alone	136,60
KPB32IMW	Stainless steel finish	Wireless online	240,65
KPB32IPW	Polished stainless steel finish	Wireless online	259,30
KPB32IMA7	Stainless steel finish	Amok Picopass	159,00
KPB32IPA7	Polished stainless steel finish	Amok Picopass	184,20
KPB32IMA8	Stainless steel finish	Amok LEGIC Advant	149,65
KPB32IPA8	Polished stainless steel finish	Amok LEGIC Advant	173,45
KPB32IMA9	Stainless steel finish	Amok Mifare DESFire	149,65
KPB32IPA9	Polished stainless steel finish	Amok Mifare DESFire	173,45
KPB32IMAH	Stainless steel finish	Amok HID iCLASS	174,55
KPB32IPAH	Polished stainless steel finish	Amok HID iCLASS	202,15

Panic Bar	Mortise Lock Needed	Mortise Lock Drawing	Escutcheon Needed	Note
TESA TEMPRO TM1	TESA CF60T RF FIRE 72 PZ		Ei450m7FffH9 Ei454m7FffH9 Ei460m7FffH9	Wireless Possible (Except Split Spindle) ONLY 7F Models
			Ei650m7FffH9 Ei654m7FffH9 Ei6E0m7FffH9	

KPB33

SALTO XS4 Panic Bar Kit for versions of ANTIPANIC PBA1200

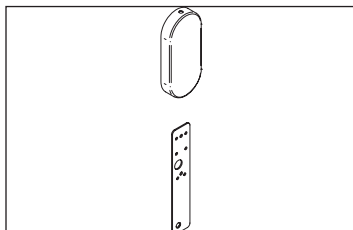

Prices - Gross prices			€
Product	Finish	Offline stand alone or Wireless online	
KPB33IM	Stainless steel finish	Offline stand alone	201,40
KPB33IP	Polished stainless steel finish	Offline stand alone	220,15
KPB33IMW	Stainless steel finish	Wireless online	331,20
KPB33IPW	Polished stainless steel finish	Wireless online	349,85
KPB33IMA7	Stainless steel finish	Amok Picopass	271,45
KPB33IPA7	Polished stainless steel finish	Amok Picopass	296,80
KPB33IMA8	Stainless steel finish	Amok LEGIC Advant	255,60
KPB33IPA8	Polished stainless steel finish	Amok LEGIC Advant	279,45
KPB33IMA9	Stainless steel finish	Amok Mifare DESFire	255,60
KPB33IPA9	Polished stainless steel finish	Amok Mifare DESFire	279,45
KPB33IMAH	Stainless steel finish	Amok HID iCLASS	298,00
KPB33IPAH	Polished stainless steel finish	Amok HID iCLASS	325,75

Panic Bar	Mortise Lock Needed	Mortise Lock Drawing	Escutcheon Needed	Note
PBA120020 ANTIPANIC	LE7A0165R40ffV		Ei450m7FffH9 Ei454m7FffH9 Ei460m7FffH9 Ei650m7FffH9 Ei654m7FffH9 Ei6E0m7FffH9	Wireless Possible Only 7F Models

KPB34

SALTO XS4 Panic Bar Kit for versions of HEWI PS160XA and PS111XA

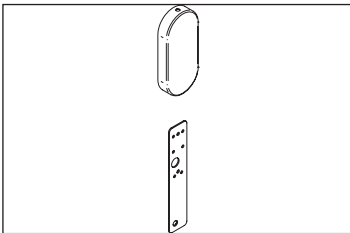

Prices - Gross prices			€
Product	Finish	Offline stand alone or Wireless online	
KPB34IM	Stainless steel finish	Offline stand alone	126,55
KPB34IP	Polished stainless steel finish	Offline stand alone	145,10
KPB34IMW	Stainless steel finish	Wireless online	249,30
KPB34IPW	Polished stainless steel finish	Wireless online	268,05
KPB34IMA7	Stainless steel finish	Amok Picopass	170,60
KPB34IPA7	Polished stainless steel finish	Amok Picopass	195,85
KPB34IMA8	Stainless steel finish	Amok LEGIC Advant	160,60
KPB34IPA8	Polished stainless steel finish	Amok LEGIC Advant	184,35
KPB34IMA9	Stainless steel finish	Amok Mifare DESFire	160,60
KPB34IPA9	Polished stainless steel finish	Amok Mifare DESFire	184,35
KPB34IMAH	Stainless steel finish	Amok HID iCLASS	187,30
KPB34IPAH	Polished stainless steel finish	Amok HID iCLASS	214,95

Panic Bar	Mortise Lock Needed	Mortise Lock Drawing	Escutcheon Needed	Note
HEWI PS160XA HEWI PS111XA	DIN 18250 72/92 PZ		Ei450m00ffH9 Ei454m00ffH9 Ei460m00ffH9 Ei460m00ffH9	Wireless Possible (Except Split Spindles)

KPB35

SALTO XS4 Panic Bar Kit for versions of JPM ONE, LIPS FREEDOM, VACHETTE 6500, 1600 and UNION 881

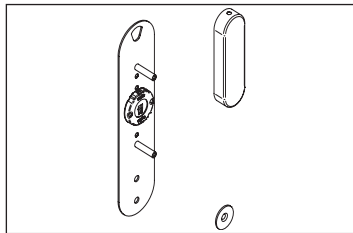

Prices - Gross prices			€
Product	Finish	Offline stand alone or Wireless online	
KPB35IM	Stainless steel finish	Offline stand alone	201,40
KPB35IP	Polished stainless steel finish	Offline stand alone	220,15
KPB35IMW	Stainless steel finish	Wireless online	331,20
KPB35IPW	Polished stainless steel finish	Wireless online	349,85
KPB35IMA7	Stainless steel finish	Amok Picopass	227,60
KPB35IPA7	Polished stainless steel finish	Amok Picopass	252,70
KPB35IMA8	Stainless steel finish	Amok LEGIC Advant	214,25
KPB35IPA8	Polished stainless steel finish	Amok LEGIC Advant	237,90
KPB35IMA9	Stainless steel finish	Amok Mifare DESFire	214,25
KPB35IPA9	Polished stainless steel finish	Amok Mifare DESFire	237,90
KPB35IMAH	Stainless steel finish	Amok HID iCLASS	249,85
KPB35IPAH	Polished stainless steel finish	Amok HID iCLASS	277,35

Panic Bar	Mortise Lock Needed	Mortise Lock Drawing	Escutcheon Needed	Note
JPM PUSH ONE JPM BAR ONE (Surface Single Point)			Ei650m00ffH8 Ei660m00ffH8 Ei6E0m00ffH8 Ei6P0m00ffH8	Opening from the inside detection not possible
LIPS FREEDOM LINE (Surface Single Point)			Ei650m00ffH8 Ei660m00ffH8 Ei6E0m00ffH8 Ei6P0m00ffH8	Opening from the inside detection not possible
LIPS FREEDOM LINE (Surface Single Point)			Ei650m00ffH8 Ei660m00ffH8 Ei6E0m00ffH8 Ei6P0m00ffH8	Opening from the inside detection not possible
UNION 881 (Surface Single Point)			Ei650m00ffH8 Ei660m00ffH8 Ei6E0m00ffH8 Ei6P0m00ffH8	Opening from the inside detection not possible

KPB36

SALTO XS4 Panic Bar Kit for versions of TESA TOP1S and TESA TOP1D

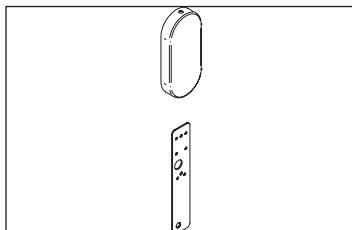

Prices - Gross prices			€
Product	Finish	Offline stand alone or Wireless online	
KPB36IM	Stainless steel finish	Offline stand alone	117,95
KPB36IP	Polished stainless steel finish	Offline stand alone	136,60
KPB36IMW	Stainless steel finish	Wireless online	240,65
KPB36IPW	Polished stainless steel finish	Wireless online	259,30
KPB36IMA7	Stainless steel finish	Amok Picopass	159,00
KPB36IPA7	Polished stainless steel finish	Amok Picopass	184,20
KPB36IMA8	Stainless steel finish	Amok LEGIC Advant	149,65
KPB36IPA8	Polished stainless steel finish	Amok LEGIC Advant	173,45
KPB36IMA9	Stainless steel finish	Amok Mifare DESFire	149,65
KPB36IPA9	Polished stainless steel finish	Amok Mifare DESFire	173,45
KPB36IMAH	Stainless steel finish	Amok HID iCLASS	174,55
KPB36IPAH	Polished stainless steel finish	Amok HID iCLASS	202,15

Panic Bar	Mortise Lock Needed	Mortise Lock Drawing	Escutcheon Needed	Note
TESA TOP1S TESA TOP1D			Ai650m00ffH8 Ai660m00ffH8	Opening from the inside detection not possible

KPB37

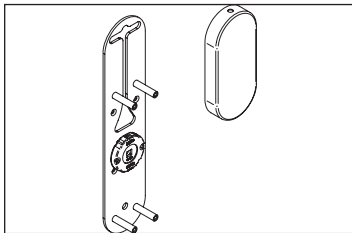

SALTO XS4 Panic Bar Kit for versions of VON DUPRIN .



Prices - Gross prices			€
Product	Finish	Offline stand alone or Wireless online	
KPB37IM	Stainless steel finish	Offline stand alone	201,40
KPB37IP	Polished stainless steel finish	Offline stand alone	220,15
KPB37IMW	Stainless steel finish	Wireless online	324,20
KPB37IPW	Polished stainless steel finish	Wireless online	342,30
KPB37IMA7	Stainless steel finish	Amok Picopass	271,45
KPB37IPA7	Polished stainless steel finish	Amok Picopass	296,80
KPB37IMA8	Stainless steel finish	Amok LEGIC Advant	255,60
KPB37IPA8	Polished stainless steel finish	Amok LEGIC Advant	279,45
KPB37IMA9	Stainless steel finish	Amok Mifare DESFire	255,60
KPB37IPA9	Polished stainless steel finish	Amok Mifare DESFire	279,45
KPB37IMAH	Stainless steel finish	Amok HID iCLASS	298,00
KPB37IPAH	Polished stainless steel finish	Amok HID iCLASS	325,75

Panic Bar	Mortise Lock Needed	Mortise Lock Drawing	Escutcheon Needed	Note
Von Duprin 98 / 9947 (Concealed rod)			Ai650m00ffP8 Ai660m00ffP8	Opening from the inside detection not possible



Wireless version available - no inside handle opening detection.

* UL Listed in combination with SALTO PBF1100 RIM panic bar and SALTO ANSI escutcheon Ax650xxxH8U series. If used with a panic bar device from another manufacturer, the UL listing does not apply.

KPB39

SALTO XS4 Panic Bar Kit for versions of SARGENT 8800 prior to 2002.

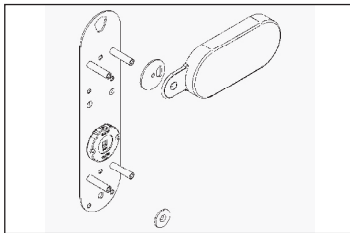

Prices - Gross prices			€
Product	Finish	Offline stand alone or Wireless online	
KPB39IM	Stainless steel finish	Offline stand alone	164,00
KPB39IP	Polished stainless steel finish	Offline stand alone	182,75
KPB39IMW	Stainless steel finish	Wireless online	286,70
KPB39IPW	Polished stainless steel finish	Wireless online	304,80
KPB39IMA7	Stainless steel finish	Amok Picopass	221,10
KPB39IPA7	Polished stainless steel finish	Amok Picopass	246,40
KPB39IMA8	Stainless steel finish	Amok LEGIC Advant	208,20
KPB39IPA8	Polished stainless steel finish	Amok LEGIC Advant	231,95
KPB39IMA9	Stainless steel finish	Amok Mifare DESFire	208,20
KPB39IPA9	Polished stainless steel finish	Amok Mifare DESFire	231,95
KPB39IMAH	Stainless steel finish	Amok HID iCLASS	242,65
KPB39IPAH	Polished stainless steel finish	Amok HID iCLASS	270,45

Panic Bar	Mortise Lock Needed	Mortise Lock Drawing	Escutcheon Needed	Note
Sargent 8800 (Single point)			Ai650m00ffP7 Ai660m00ffP7	Opening from the inside detection not possible



Wireless version available - no inside handle opening detection.

KPB40

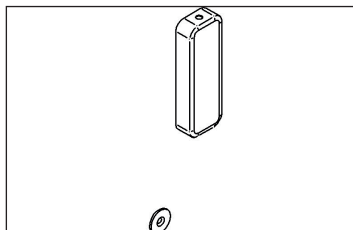

SALTO XS4 One Panic Bar Kit for versions of ECO and BKS.

Prices - Gross prices			€
Product	Finish	Offline stand alone or Wireless online	
KPB40IM	Stainless steel finish	Offline stand alone	118,30
KPB40IP	Polished stainless steel finish	Offline stand alone	136,85





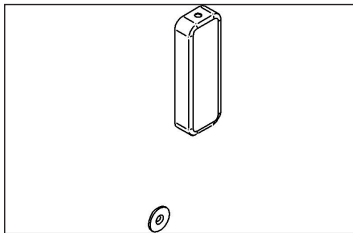

Panic Bar	Mortise Lock Needed	Mortise Lock Drawing	Escutcheon Needed	Note
BKS B7100 61	BKS Series 21xx Series 23xx Typ A, Typ B		Ei750m00ffD9 Ei754m72ffD9 Ei7P0m00ffD9	Opening from the inside detection possible except split spindle
	BKS Series 1125 Typ B		Ei750m7FffD9 Ei754m7FffD9	Opening from the inside detection possible except split spindle
	BKS Series 18xx Series 19xx Typ A, Typ B		Ei750m00ffD9 Ei754m92ffD9 Ei7P0m00ffD9	Opening from the inside detection possible except split spindle
BKS B7150	BKS Series 18xx Series 19xx Typ A, Typ B		Ei750m00ffD9 Ei754m92ffD9 Ei7P0m00ffD9	Opening from the inside detection possible except split spindle
BKS B7100 51 BKS B7172 51 BKS B7192 51	BKS Series 21xx Series 23xx Typ A, Typ B		Ei750m7FffD9 Ei754m7FffD9	Opening from the inside detection possible except split spindle
	BKS Series 1125 Typ B			
	BKS Series 18xx Series 19xx Typ A, Typ B		Ei750m7FffD9	
ECO EPN900-30 (turning Hub 30°)	DIN 18250 72 PZ		Ei750m7FffD9 Ei754m7FffD9	Opening from the inside detection possible except split spindle
	GBS96C GBS97C GBS98 (Panicfunction C)		Ei750m7FffD9	Opening from the inside detection possible except split spindle
ECO EPN2000	DIN 18250 72 PZ		Ei750m00ffD9 Ei754m92ffD9 Ei7P0m00ffD9	Opening from the inside detection possible except split spindle
	GBS96C GBS97C (Panicfunction C)			

KPB41

SALTO XS4 One Panic Bar Kit for versions of CISA.



Prices - Gross prices			€
Product	Finish	Offline stand alone or Wireless online	
KPB41IM	Stainless steel finish	Offline stand alone	118,30
KPB41 IP	Polished stainless steel finish	Offline stand alone	136,85



Panic Bar	Mortise Lock Needed	Mortise Lock Drawing	Escutcheon Needed	Note
CISA 59615 CISA 59616	DIN 18250 72 PZ		Ei750m7FffD9 Ei754m7FffD9	
	Type RF Fire 72 PZ		Ei750m7FffD9 Ei754m7FffD9	
	Metal frame 92 PZ		Ei750m7FffD9	
CISA 59710 CISA 59711	DIN 18250 72 PZ		Ei750m00ffD9 Ei754m72ffD9 Ei7P0m00ffD9	
	Type RF Fire 72 PZ		Ei750m7FffD9 Ei754m7FffD9	
	Metal frame 92 PZ		Ei750m00ffD9 Ei754m92ffD9 Ei7P0m00ffD9	

KPB42

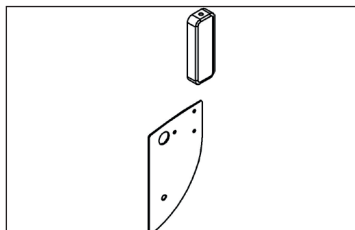
SALTO XS4 One Panic Bar Kit for versions of NINZ SLASH.



Prices - Gross prices			€
Product	Finish	Offline stand alone or Wireless online	
KPB42IM	Stainless steel finish	Offline stand alone	126,55
KPB42IP	Polished stainless steel finish	Offline stand alone	145,10

Panic Bar	Mortise Lock Needed	Mortise Lock Drawing	Escutcheon Needed	Note
NINZ SLASH	Type RF Fire 72 PZ		Ei750m7FffD9 Ei754m7FffD9	
	Metal frame 92 PZ		Ei750m7FffD9	

KPB43

SALTO XS4 One Panic Bar Kit for versions of TESA .

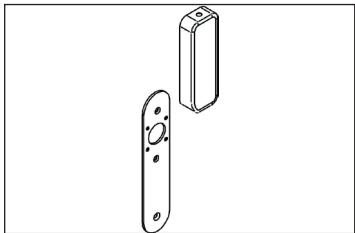

Prices - Gross prices			€
Product	Finish	Offline stand alone or Wireless online	
KPB43IM	Stainless steel finish	Offline stand alone	126,55
KPB43IP	Polished stainless steel finish	Offline stand alone	145,10

Panic Bar	Mortise Lock Needed	Mortise Lock Drawing	Escutcheon Needed	Note
TESA TEMPRO TM1E	TESA 2035T / 4039T 85PZ		Ei750m00ffH8 Ei754m85ffH8 Ei7P0m00ffH8	

KPB44

SALTO XS4 One Panic Bar Kit for versions of TESA .

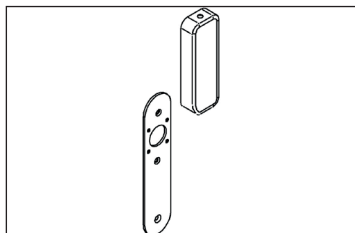

Prices - Gross prices			€
Product	Finish	Offline stand alone or Wireless online	
KPB44IM	Stainless steel finish	Offline stand alone	126,55
KPB44IP	Polished stainless steel finish	Offline stand alone	145,10

Panic Bar	Mortise Lock Needed	Mortise Lock Drawing	Escutcheon Needed	Note
TESA TEMPRO TM1E	TESA CF60T RF FIRE 72PZ		Ei750m7FffD9 Ei754m7FffD9	



KPB45

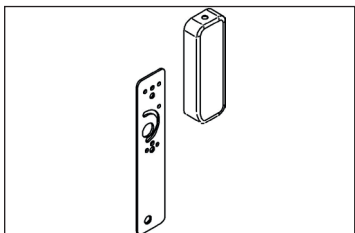

SALTO XS4 One Panic Bar Kit for versions of SALTO PBA120020 and ANTIPANIC.



Prices - Gross prices			€
Product	Finish	Offline stand alone or Wireless online	
KPB45IM	Stainless steel finish	Offline stand alone	153,95
KPB45IP	Polished stainless steel finish	Offline stand alone	278,70

Panic Bar	Mortise Lock Needed	Mortise Lock Drawing	Escutcheon Needed	Note
SALTO PBA120020	LE7A0165R40fv		Ei750m7FffD9 Ei754m7FffD9	

KPB46	SALTO XS4 One Panic of HEWI		
 	Prices - Gross prices		€
	Product	Finish	Offline stand alone or Wireless online
	KPB46IM	Stainless steel finish	Offline stand alone
	KPB46IP	Polished stainless steel finish	Offline stand alone
			118,30
			136,85

Panic Bar	Mortise Lock Needed	Mortise Lock Drawing	Escutcheon Needed	Note
HEWI PS160XA HEWI PS111XA	DIN 18250 72 PZ		Ei750m00ffD9 Ei754m00ffD9 Ei7P0m00ffD9	Opening from the inside detection possible except split spindle
	DIN 18250 92 PZ			

KPB47

SALTO XS4 Panic Bar Kit for versions of HAGER .

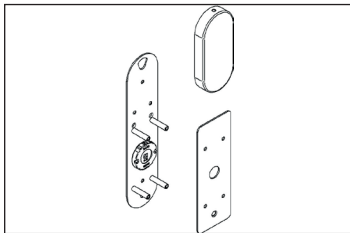

Prices - Gross prices			€
Product	Finish	Offline stand alone or Wireless online	
KPB47IM	Stainless steel finish	Offline stand alone	201,40
KPB47IP	Polished stainless steel finish	Offline stand alone	220,15
KPB47IMW	Stainless steel finish	Wireless online	324,20
KPB47IPW	Polished stainless steel finish	Wireless online	342,30
KPB47IMA7	Stainless steel finish	Amok Picopass	271,45
KPB47IPA7	Polished stainless steel finish	Amok Picopass	296,80
KPB47IMA8	Stainless steel finish	Amok LEGIC Advant	255,60
KPB47IPA8	Polished stainless steel finish	Amok LEGIC Advant	279,45
KPB47IMA9	Stainless steel finish	Amok Mifare DESFire	255,60
KPB47IPA9	Polished stainless steel finish	Amok Mifare DESFire	279,45
KPB47IMAH	Stainless steel finish	Amok HID iCLASS	298,00
KPB47IPAH	Polished stainless steel finish	Amok HID iCLASS	325,75

Panic Bar	Mortise Lock Needed	Mortise Lock Drawing	Escutcheon Needed	Note
HAGER 4500			Ai650m00ffH8 Ai660m00ffH8	Opening from the inside detection not possible



Wireless version available - no inside handle opening detection.

KPB48

SALTO XS4 Panic Bar Kit for versions of DORMA and FAPIM PANAMA

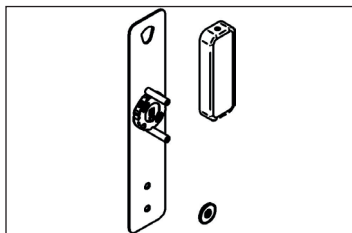

Prices - Gross prices			€
Product	Finish	Offline stand alone or Wireless online	
KPB48IM	Stainless steel finish	Offline stand alone	168,80
KPB48IP	Polished stainless steel finish	Offline stand alone	187,45

Panic Bar	Mortise Lock Needed	Mortise Lock Drawing	Escutcheon Needed	Note
DORMA PHA2102 DORMA PHB3102			Ei750m00ffccH8 Ei7P0m00ffccH8	Opening from the inside detection not possible
FAPIM PANAMA 8012			Ei750m00ffccH8 Ei7P0m00ffccH8	



Wireless version available - no inside handle opening detection.

KPB49

SALTO XS4 Panic Bar Kit for versions of TESA OIASSO & TESA LITE 1E .

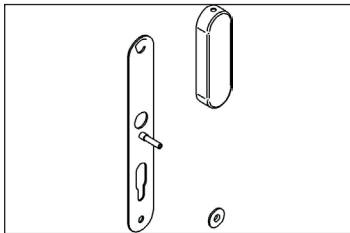

Prices - Gross prices			€
Product	Finish	Offline stand alone or Wireless online	
KPB49IM	Stainless steel finish	Offline stand alone	126,55
KPB49IP	Polished stainless steel finish	Offline stand alone	145,10
KPB49IMW	Stainless steel finish	Wireless online	249,30
KPB49IPW	Polished stainless steel finish	Wireless online	268,05
KPB49IMA7	Stainless steel finish	Amok Picopass	170,60
KPB49IPA7	Polished stainless steel finish	Amok Picopass	195,85
KPB49IMA8	Stainless steel finish	Amok LEGIC Advant	160,60
KPB49IPA8	Polished stainless steel finish	Amok LEGIC Advant	184,35
KPB49IMA9	Stainless steel finish	Amok Mifare DESFire	160,60
KPB49IPA9	Polished stainless steel finish	Amok Mifare DESFire	184,35
KPB49IMAH	Stainless steel finish	Amok HID iCLASS	187,30
KPB49IPAH	Polished stainless steel finish	Amok HID iCLASS	214,95



Panic Bar	Mortise Lock Needed	Mortise Lock Drawing	Escutcheon Needed	Note
TESA OIASSO QUICK 1E	TESA 2035T/4039T 85PZ		Ei450m00ffH8 Ei454m85ffH8 Ei4P0m00ffH8	Wireless possible (Except Split spindle)
TESA LITE 1E	TESA 2035T/4039T 85PZ		Ei450m00ffH8 Ei454m85ffH8 Ei4P0m00ffH8	

KPB50

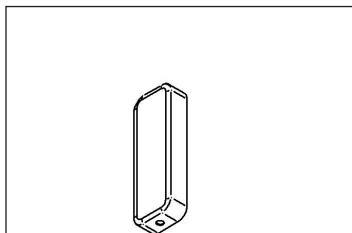
SALTO XS4 Panic Bar Kit for versions of TESA OIASSO & TESA LITE 1E.



Prices - Gross prices			€
Product	Finish	Offline stand alone or Wireless online	
KPB50IM	Stainless steel finish	Offline stand alone	153,95
KPB50IP	Polished stainless steel finish	Offline stand alone	172,60



Panic Bar	Mortise Lock Needed	Mortise Lock Drawing	Escutcheon Needed	Note
TESA OIASSO QUICK 1E	TESA CF60T RF FIRE 72PZ		Ei750m7FffD9 Ei754m7FffD9	Wireless possible (Except Split spindle)
TESA LITE 1E	TESA CF60T RF FIRE 72PZ		Ei750m7FffD9 Ei754m7FffD9	

KPB51

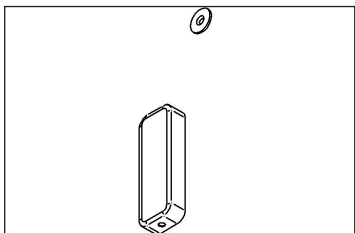
SALTO XS4 Panic Bar Kit for versions of TESA OIASSO & TESA LITE 1E.



Prices - Gross prices			€
Product	Finish	Offline stand alone or Wireless online	
KPB51IM	Stainless steel finish	Offline stand alone	118,30
KPB51IP	Polished stainless steel finish	Offline stand alone	136,85

Panic Bar	Mortise Lock Needed	Mortise Lock Drawing	Escutcheon Needed	Note
TESA OIASSO QUICK 1E	TESA 2035T/4039T 85PZ		Ei750m00ffD8 Ei754m85ffD8 Ei7P0m00ffD8	Wireless possible (Except Split spindle)
TESA LITE 1E	TESA 2035T/4039T 85PZ		Ei750m00ffD8 Ei754m85ffD8 Ei7P0m00ffD8	

KPB52

SALTO XS4 Panic Bar Kit for versions of TESA OIASSO & TESA LITE 1E.

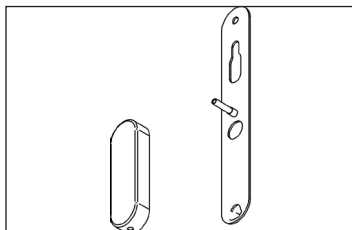

Prices - Gross prices			€
Product	Finish	Offline stand alone or Wireless online	
KPB52IM	Stainless steel finish	Offline stand alone	144,85
KPB52IP	Polished stainless steel finish	Offline stand alone	248,95
KPB52IMW	Stainless steel finish	Wireless online	267,75
KPB52IPW	Polished stainless steel finish	Wireless online	132,00
KPB36IMA7	Stainless steel finish	Amok Picopass	170,30
KPB36IPA7	Polished stainless steel finish	Amok Picopass	195,40
KPB52IMA8	Stainless steel finish	Amok LEGIC Advant	160,35
KPB52IPA8	Polished stainless steel finish	Amok LEGIC Advant	184,00
KPB52IMA9	Stainless steel finish	Amok Mifare DESFire	160,35
KPB52IPA9	Polished stainless steel finish	Amok Mifare DESFire	184,00
KPB52IMAH	Stainless steel finish	Amok HID iCLASS	186,90
KPB52IPAH	Polished stainless steel finish	Amok HID iCLASS	214,45

Panic Bar	Mortise Lock Needed	Mortise Lock Drawing	Escutcheon Needed	Note
TESA OIASSO QUICK 1E	TESA CF60T RF FIRE 72PZ		Ei450m7FffH9 Ei454m7FffH9	Wireless possible (Except Split spindle)
TESA LITE 1E	TESA CF60T RF FIRE 72PZ		Ei450m7FffH9 Ei454m7FffH9	

KPB53

SALTO XS4 Panic Bar Kit for versions of DLINE .

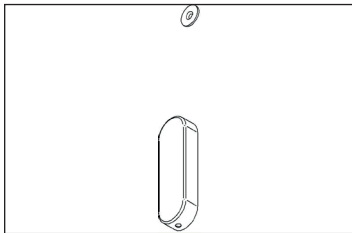

Prices - Gross prices			€
Product	Finish	Offline stand alone or Wireless online	
KPB53IM	Stainless steel finish	Offline stand alone	117,95
KPB53IP	Polished stainless steel finish	Offline stand alone	136,60
KPB53IMW	Stainless steel finish	Wireless online	240,65
KPB53IPW	Polished stainless steel finish	Wireless online	259,30
KPB53IMA7	Stainless steel finish	Amok Picopass	159,00
KPB53IPA7	Polished stainless steel finish	Amok Picopass	184,20
KPB53IMA8	Stainless steel finish	Amok LEGIC Advant	149,65
KPB53IPA8	Polished stainless steel finish	Amok LEGIC Advant	173,45
KPB53IMA9	Stainless steel finish	Amok Mifare DESFire	149,65
KPB53IPA9	Polished stainless steel finish	Amok Mifare DESFire	173,45
KPB53IMAH	Stainless steel finish	Amok HID iCLASS	174,55
KPB53IPAH	Polished stainless steel finish	Amok HID iCLASS	202,15



Panic Bar	Mortise Lock Needed	Mortise Lock Drawing	Escutcheon Needed	Note
DLINE 14 5122 02 004	Type RF FIRE 72PZ		Ei450m7FffH9 Ei454m7FffH9	Opening from the inside detection not possible

KPB54

SALTO XS4 Panic Bar Kit for versions of DLINE.

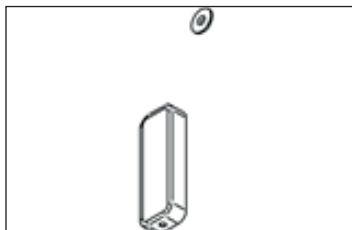

Prices - Gross prices			€
Product	Finish	Offline stand alone or Wireless online	
KPB54IM	Stainless steel finish	Offline stand alone	118,30
KPB54IP	Polished stainless steel finish	Offline stand alone	136,85

Panic Bar	Mortise Lock Needed	Mortise Lock Drawing	Escutcheon Needed	Note
DLINE 14 5122 02 004	Type RF FIRE 72PZ		Ei750m7FffH9 Ei754m7FffH9	Opening from the inside detection not possible

KPB55

SALTO XS4 Panic Bar Kit for versions of DORMA 9100 (Concealed Rod) .

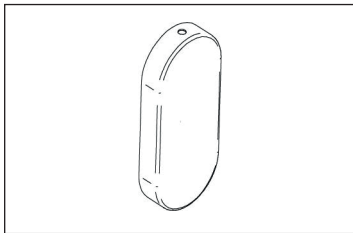

Prices - Gross prices			€
Product	Finish	Offline stand alone or Wireless online	
KPB55IM	Stainless steel finish	Offline stand alone	164,00
KPB55IP	Polished stainless steel finish	Offline stand alone	182,75
KPB55IMW	Stainless steel finish	Wireless online	286,70
KPB55IPW	Polished stainless steel finish	Wireless online	304,80
KPB55IMA7	Stainless steel finish	Amok Picopass	221,10
KPB55IPA7	Polished stainless steel finish	Amok Picopass	246,40
KPB55IMA8	Stainless steel finish	Amok LEGIC Advant	208,20
KPB55IPA8	Polished stainless steel finish	Amok LEGIC Advant	231,95
KPB55IMA9	Stainless steel finish	Amok Mifare DESFire	208,20
KPB55IPA9	Polished stainless steel finish	Amok Mifare DESFire	231,95
KPB55IMAH	Stainless steel finish	Amok HID iCLASS	242,65
KPB55IPAH	Polished stainless steel finish	Amok HID iCLASS	270,45

Panic Bar	Mortise Lock Needed	Mortise Lock Drawing	Escutcheon Needed	Note
DORMA 9100 (Concealed Rod)			Ai650m00ffP8 Ai660m00ffP8	Opening from the inside detection not possible

KPB56

SALTO XS4 Panic Bar Kit for versions of CISA 59001 (Rim Exit Device)



Prices - Gross prices			€
Product	Finish	Offline stand alone or Wireless online	
KPB56IM	Stainless steel finish	Offline stand alone	157,15
KPB56IP	Polished stainless steel finish	Offline stand alone	175,75
KPB56IMW	Stainless steel finish	Wireless online	279,80
KPB56IPW	Polished stainless steel finish	Wireless online	297,95
KPB56IMA7	Stainless steel finish	Amok Picopass	211,85
KPB56IPA7	Polished stainless steel finish	Amok Picopass	237,00
KPB56IMA8	Stainless steel finish	Amok LEGIC Advant	199,45
KPB56IPA8	Polished stainless steel finish	Amok LEGIC Advant	223,10
KPB56IMA9	Stainless steel finish	Amok Mifare DESFire	199,45
KPB56IPA9	Polished stainless steel finish	Amok Mifare DESFire	223,10
KPB56IMAH	Stainless steel finish	Amok HID iCLASS	232,50
KPB56IPAH	Polished stainless steel finish	Amok HID iCLASS	260,15
KPB56IMAB	Stainless steel finish	Amok Mifare BLE	205,90
KPB56IPAB	Polished stainless steel finish	Amok Mifare BLE	230,30

Panic Bar	Mortise Lock Needed	Mortise Lock Drawing	Escutcheon Needed	Note
CISA 59001 (Single point)			Ei650m00ff-H8 Ei660m00ff-H8 Ei6E0m00ff-H8 Ei6P0m00ff-H8	Opening from the inside detection not possible

Special wire for doors thickness >120mm

€

Special wire for doors thickness >120mm	SP 0 1 0 4 5 - 3 5 0	10,55
---	----------------------	-------



**Model Gateway
SALTO BLUEnet**

SALTO Wireless gateway for SALTO BLUEnet wireless systems.
Can manage up to 6 nodes plus the internal node and 16 escutcheons
Ethernet connection to the PC, PoE

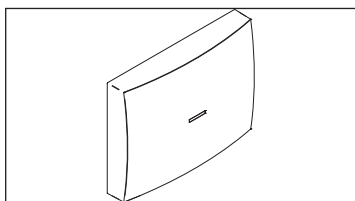

Prices - Gross prices		€
Description	Reference	
SALTO BLUEnet Wireless gateway PoE, White	G A T E W A Y W 3 C *	267,15
SALTO BLUEnet Wireless gateway PoE, Black	G A T E W A Y B 3 C *	

If you need 12V AC adaptor complete the reference using:
 EU with 12v European power adaptor
 UK with 12v UK power adaptor
 US with 12v US power adaptor
 AUS with 12v Australian power adaptor.

Just for SALTO Wireless platforms based on SALTO ProAccess SPACE software versions.

**Model SALTO
BLUEnet node**

SALTO BLUEnet RF node Kit.
Kit to boost the scope escutcheons to wireless escutcheons. Need to be connected to one GATEWAY3 or GATEWAY2 by 485 bus connection. Power by the GATEWAY.

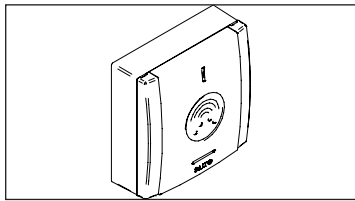

Prices - Gross prices		€
Description	Reference	
SALTO XS4 RF node for SALTO BLUEnet	R F N O D E 3	69,85
SALTO XS4 RF node for SALTO BLUEnet, White	R F N O D E 3 W	
SALTO XS4 RF node for SALTO BLUEnet, Black	R F N O D E 3 B	

Just for SALTO Wireless platforms based on SALTO ProAccess SPACE software versions.

**Model SALTO
BLUEnet repeater**

SALTO BLUEnet Repeater.
Device that permits to extend the distance between the gateway and the locks
Connectes to GATEWAY3 by wireless BLUEnet connection. 12V Power supply included.

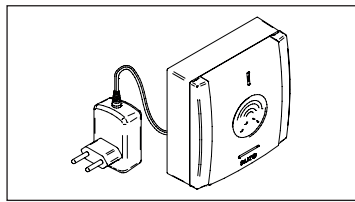

Prices - Gross prices		€
Description	Reference	
SALTO BLUEnet repeater	R E P E A T E R 0 3 *	69,85
SALTO BLUEnet repeater, White	R E P E A T E R 0 3 W *	
SALTO BLUEnet repeater, Black	R E P E A T E R 0 3 B *	

* If Requires power adaptor included in the product, please complete the reference using:
 EU with 12v European power adaptor
 UK with 12v UK power adaptor
 US with 12v US power adaptor
 AUS with 12v Australian power adaptor.

Just for SALTO Wireless platforms based on SALTO ProAccess SPACE software versions.

**Model BLUEnet
inRoomNode**

SALTO BLUEnet inRoomNode.

A smart peripheral device that connects SALTO BLUEnet electronic locks to the guest room ecosystem. Ethernet connection to the PC, PoE



Prices - Gross prices

€

Description	Reference
SALTO BLUEnet inRoomNode without cable	I R N 0 3 C 0 0
SALTO BLUEnet inRoomNode standard (without connector)	I R N 0 3 C 0 1
SALTO BLUEnet inRoomNode INTEREL	I R N 0 3 C 0 2
SALTO BLUEnet inRoomNode TELKONET	I R N 0 3 C 0 3
SALTO BLUEnet inRoomNode VDA	I R N 0 3 C 0 4
SALTO BLUEnet inRoomNode INNCOM	I R N 0 3 C 0 5

55,00

Model Gateway

SALTO Wireless gateway.

Can manage up to 4 repeaters and 16 escutcheons
Ethernet connection to the PC, PoE

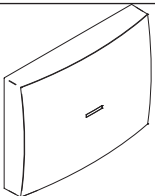

Prices - Gross prices

€

Description	Reference
SALTO XS4 Wireless gateway PoE, White	G A T E W A Y W 1 C *
SALTO XS4 Wireless gateway PoE, Black	G A T E W A Y B 1 C *

267,15

If you need 12V AC adaptor complete the reference using:

- EU with 12v European power adaptor
- UK with 12v UK power adaptor
- AUS with 12v Australian power adaptor.

**Model Gateway for
Wireless RFnet**

SALTO Wireless gateway for wireless 2 systems.

Can manage up to 6 nodes plus the internal node and 16 escutcheons
Ethernet connection to the PC, PoE

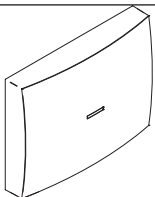

Prices - Gross prices

€

Description	Reference
SALTO XS4 Wireless gateway PoE, White	G A T E W A Y W 2 C *
SALTO XS4 Wireless gateway PoE, Black	G A T E W A Y B 2 C *

267,15

If you need 12V AC adaptor complete the reference using:

- EU with 12v European power adaptor
- UK with 12v UK power adaptor
- AUS with 12v Australian power adaptor.



Just for SALTO Wireless platforms based on SERVICE software versions.
to convert from Wireless 1 to Wireless 2 platforms, the RF hardware needs to be replaced (GATEWAYS and REPEATERS).

Model RF node for Wireless RFnet



SALTO Wireless node Kit.
Kit to boost the scope escutcheons to wireless escutcheons. Need to be connected to one GATEWAY2 or GATEWAY3 by 485 bus connection. Power by the GATEWAY.

Prices - Gross prices		€
Description	Reference	
SALTO XS4 RF node for wireless RFnet	R F N O D E	69,85
SALTO XS4 RF node for wireless RFnet, White	R F N O D E W	
SALTO XS4 RF node for wireless RFnet, Black	R F N O D E B	

Model Wireless antenna

SALTO Wireless Antenna Kit.
Kit to convert stand-alone escutcheons to wireless escutcheons.

Prices - Gross prices		€
Description	Reference	
SALTO XS4 Wireless antenna	R F M O D U L E W 0 1	107,85

Note: Not all the offline escutcheons can be upgraded to wireless.

Door detector

SALTO XS4 Door detector for wooden or steel doors
With plug connection for the SALTO wireless escutcheon
Different detector depending on the door and the escutcheon model

Prices - Gross prices		€
Description	Reference	
SALTO XS4 Door detector for wooden doors For narrow body escutcheons.	R F D T C T W 3 0 W 0 1	23,30
SALTO XS4 Door detector for wooden doors For wide body escutcheons.	R F D T C T W 1 8 W 0 1	23,30
SALTO XS4 Door detector for steel doors For narrow body escutcheons.	R F D T C T S 3 0 W 0 1	38,50
SALTO XS4 Door detector for steel doors For wide body escutcheons.	R F D T C T S 1 8 W 0 1	38,50

Model Wireless tester kit

SALTO XS4 Wireless tester kit.
Kit for installation to measure the RF signal between 2 devices. Composed of a TESTER and a DUT device

Prices - Gross prices		€
Description	Reference	
SALTO XS4 Wireless tester kit	R F T E S T E R W 0 1	311,90

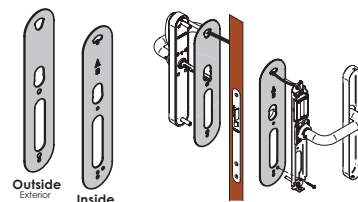

Cover Plate 045

SALTO XS4 Cover plate, for Ex02x, Ex4xx, Sx02x, Sx4xx handleset range.
 Made of steel. The set includes 2 plates (inside and outside)

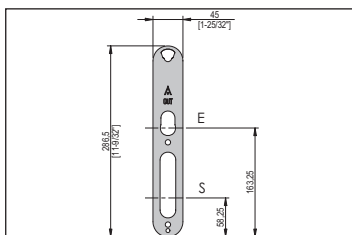

E= European axe handle.

S= Scandinavian axe handle.

Prices - Gross prices

Prices - Gross prices				€
Model	Width	Finish	Special plates	
COPL	0 4 5	I M	-	23,05
COPL	0 4 5	I P	-	26,15
COPL	0 4 5	P P	-	49,20
COPL	0 4 5	P M	-	49,20
COPL	0 4 5	I A	-	55,35
COPL	0 4 5	N E	-	36,95

Cover Plate 052

SALTO XS4 Cover plate, for Ex02x, Ex4xx, Sx02x, Sx4xx handleset range.
 Made of steel. The set includes 2 plates (inside and outside)

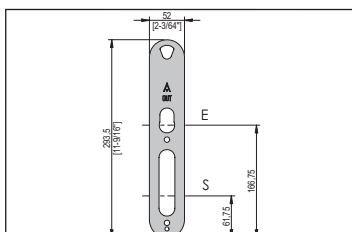

E= European axe handle.

S= Scandinavian axe handle.

Prices - Gross prices

Prices - Gross prices				€
Model	Width	Finish	Special plates	
COPL	0 5 2	I M	-	24,55
COPL	0 5 2	I P	-	27,65
COPL	0 5 2	P P	-	50,65
COPL	0 5 2	P M	-	50,65
COPL	0 5 2	I A	-	56,95
COPL	0 5 2	N E	-	38,45

Cover Plate 055

SALTO XS4 Cover plate, for Ex02x, Ex4xx, Sx02x, Sx4xx handleset range.
Made of steel. The set includes 2 plates (inside and outside)

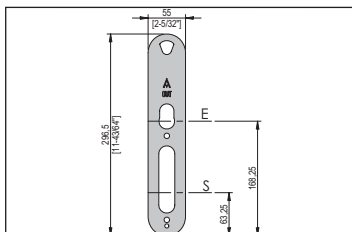

E= European axe handle.

S= Scandinavian axe handle.

Prices - Gross prices

Model	Width	Finish	Special plates	€
COPL	0 5 5	I M	-	25,40
COPL	0 5 5	I P	-	28,45
COPL	0 5 5	P P	-	52,55
COPL	0 5 5	P M	-	52,55
COPL	0 5 5	I A	-	57,65
COPL	0 5 5	N E	-	39,00

Cover Plate 065

SALTO XS4 Cover plate, for Ex02x, Ex4xx, Sx02x, Sx4xx handleset range.
Made of steel. The set includes 2 plates (inside and outside)

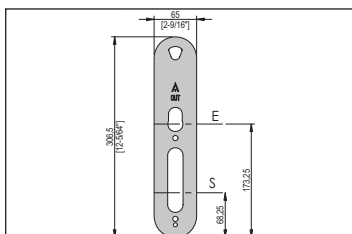

E= European axe handle.

S= Scandinavian axe handle.

Prices - Gross prices

Model	Width	Finish	Special plates	€
COPL	0 6 5	I M	-	26,90
COPL	0 6 5	I P	-	30,00
COPL	0 6 5	P P	-	53,05
COPL	0 6 5	P M	-	53,05
COPL	0 6 5	I A	-	59,10
COPL	0 6 5	N E	-	40,75

Cover Plate 075

SALTO XS4 Cover plate, for Ex02x, Ex4xx, Ex6xx, Sx02x, Sx4xx Sx96xx, Ax6xx handleset range.
Made of steel. The set includes 2 plates (inside and outside)

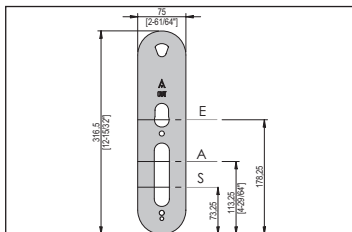

E= European axe handle.

S= Scandinavian axe handle.

A= ANSI axe handle.

Prices - Gross prices

Model	Width	Finish	Special plates	€
COPL	0 7 5	I M	-	27,65
COPL	0 7 5	I P	-	30,70
COPL	0 7 5	P P	-	53,90
COPL	0 7 5	P M	-	53,90
COPL	0 7 5	I A	-	60,05
COPL	0 7 5	N E	-	41,00

Cover Plate 085

SALTO XS4 Cover plate, for Ex02x, Ex4xx, Ex6xx, Sx02x, Sx4xx Sx6xx, Ax6xx handleset range.
 Made of steel. The set includes 2 plates (inside and outside)

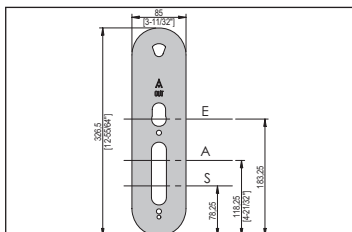

E= European axe handle.
 S= Scandinavian axe handle.
 A= ANSI axe handle.

Prices - Gross prices				€
Model	Width	Finish	Special plates	
COPL	0 8 5	I M	-	39,95
COPL	0 8 5	I P	-	43,10
COPL	0 8 5	P P	-	66,10
COPL	0 8 5	P M	-	66,10
COPL	0 8 5	I A	-	72,30
COPL	0 8 5	N E	-	53,75

Cover Plate 095

SALTO XS4 Cover plate, for Ex02x, Ex4xx, Ex6xx, Sx02x, Sx4xx Sx6xx, Ax6xx handleset range.
 Made of steel. The set includes 2 plates (inside and outside)

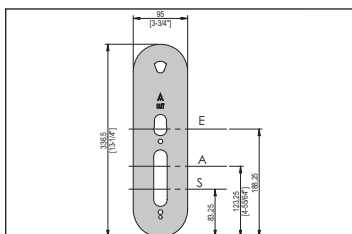

E= European axe handle.
 S= Scandinavian axe handle.
 A= ANSI axe handle.

Prices - Gross prices				€
Model	Width	Finish	Special plates	
COPL	0 9 5	I M	-	50,00
COPL	0 9 5	I P	-	52,80
COPL	0 9 5	P P	-	74,85
COPL	0 9 5	P M	-	74,85
COPL	0 9 5	I A	-	80,70
COPL	0 9 5	N E	-	63,10

Cover Plate 110

SALTO XS4 Cover plate, for Ex02x, Ex4xx, Ex6xx, Sx02x, Sx4xx Sx6xx, Ax6xx handleset range.
 Made of steel. The set includes 2 plates (inside and outside)

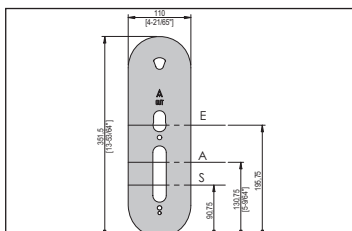

E= European axe handle.
 S= Scandinavian axe handle.
 A= ANSI axe handle.

Prices - Gross prices				€
Model	Width	Finish	Special plates	
COPL	1 1 0	I M	-	52,80
COPL	1 1 0	I P	-	55,75
COPL	1 1 0	P P	-	96,85
COPL	1 1 0	P M	-	96,85
COPL	1 1 0	I A	-	83,65
COPL	1 1 0	N E	-	66,00

Cover Plate 075KN

SALTO XS4 Cover plate, For Ex02x, Ex4xx handleset range.
Special for knob locks retrofit, made of steel. The set includes 2 plates (inside and outside)

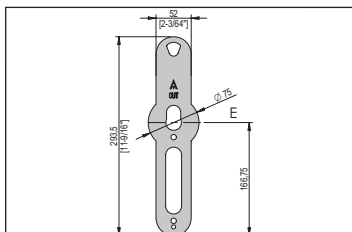

E= European axe handle.

Prices - Gross prices

Model	Width	Finish	Special plates	€
COPL	0 7 5	I M	K N	26,40
COPL	0 7 5	I P	K N	29,30
COPL	0 7 5	P P	K N	51,50
COPL	0 7 5	P M	K N	51,50
COPL	0 7 5	I A	K N	57,30
COPL	0 7 5	N E	K N	39,10

Cover Plate 055 Classic

SALTO XS4 Cover plate, For Ex02x, Ex4xx, Sx02x, Sx4xx handleset range.
Classic design, made of steel. The set includes 2 plates (inside and outside)

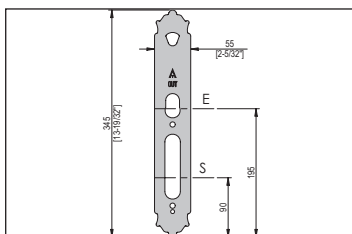

E= European axe handle.

S= Scandinavian axe handle.

Prices - Gross prices

Model	Width	Finish	Special plates	€
COPL	0 5 5	I M	C L	38,10
COPL	0 5 5	I P	C L	41,05
COPL	0 5 5	P P	C L	63,10
COPL	0 5 5	P M	C L	63,10
COPL	0 5 5	I A	C L	68,95
COPL	0 5 5	N E	C L	51,35

Cover Plate 090 Classic

SALTO XS4 Cover plate, For Ex02x, Ex4xx, Ex6xx, Sx02x, Sx4xx, Sx6xx, Ax6xx handleset range.
Classic design, made of steel. The set includes 2 plates (inside and outside)

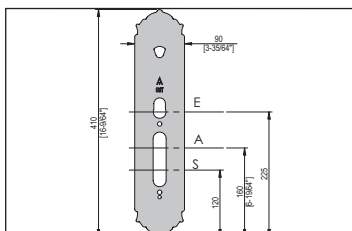

E= European axe handle.

S= Scandinavian axe handle.

A= ANSI axe handle.

Prices - Gross prices

Model	Width	Finish	Special plates	€
COPL	0 9 0	I M	C L	50,00
COPL	0 9 0	I P	C L	52,80
COPL	0 9 0	P P	C L	74,85
COPL	0 9 0	P M	C L	74,85
COPL	0 9 0	I A	C L	80,70
COPL	0 9 0	N E	C L	63,10

Cover Plate 180S

SALTO XS4 Cover plate, For Ex02x, Ex4xx, Sx02x, Sx4xx handleset range.
 Made of steel. The set includes 2 plates (inside and outside)

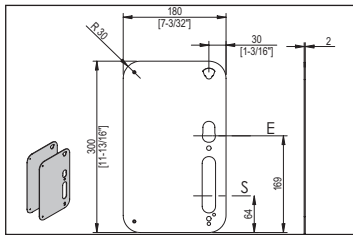

E= European axe handle.

S= Scandinavian axe handle.

4 Screws 2.9 x 13 DIN 7982 A. (Metal Door hole diameter 2.4 mm).

Prices - Gross prices				€
Model	Width	Finish	Special plates	
COPL	180S	IM	-	87,95

Cover Plate 180R

SALTO XS4 Cover plate, For Ex02x, Ex4xx, Sx02x, Sx4xx handleset range.
 Made of steel. The set includes 2 plates (inside and outside)

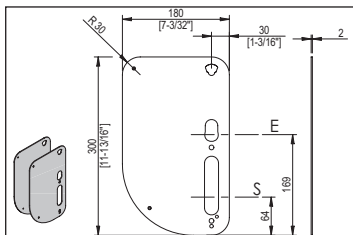

E= European axe handle.

S= Scandinavian axe handle.

4 Screws 2.9 x 13 DIN 7982 A. (Metal Door hole diameter 2.4 mm).

Prices - Gross prices				€
Model	Width	Finish	Special plates	
COPL	180R	IM	-	68,95

Cover Plate 200S

SALTO XS4 Cover plate, For Ex02x, Ex4xx, Ex6xx, Sx02x, Sx4xx, Sx6xx, Ax6xx handleset range.
 Made of steel. The set includes 2 plates (inside and outside)

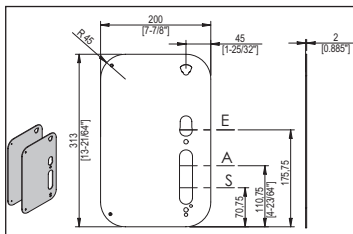

E= European axe handle.

S= Scandinavian axe handle.

A= ANSI axe handle.

4 Screws 2.9 x 13 DIN 7982 A. (Metal Door hole diameter 2.4 mm).

Prices - Gross prices				€
Model	Width	Finish	Special plates	
COPL	200S	IM	-	99,70

Cover Plate 055 Double Reader

SALTO XS4 Cover plate, For E9CDx, S9CDx handleset range.
 Made of steel. The set includes 2 plates (inside and outside)

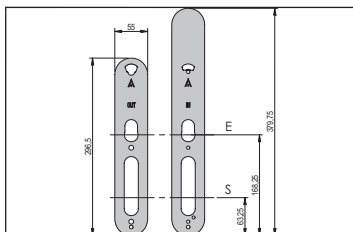

E = European axe handle.

S = Scandinavian axe handle.

Prices - Gross prices

				€
Model	Width	Finish	Special plates	
COPL	055	IM	CD	38,10

Cover Plate 180 Double Reader

SALTO XS4 Cover plate, For E9CDx, S9CDx handleset range.
 Made of steel. The set includes 2 plates (inside and outside)

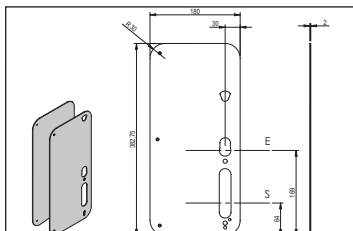

E = European axe handle.

S = Scandinavian axe handle.

4 Screws 2.9 x 13 DIN 7982 A. (Metal Door hole diameter 2.4 mm).

Prices - Gross prices

				€
Model	Width	Finish	Special plates	
COPL	180	IM	CD	133,35

Cover Plate G45

SALTO XS4 Cover plate, for SALTO XS4 One Ex7xx handleset range.
 Made of steel. The set includes 2 plates (inside and outside)

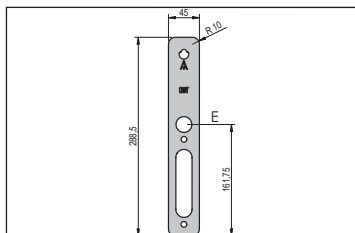

E= European axe handle.

Prices - Gross prices				€
Model	Width	Finish	Special plates	
COPL	G 4 5	I M	-	23,05
COPL	G 4 5	I P	-	26,15
COPL	G 4 5	P P	-	49,20
COPL	G 4 5	P M	-	49,20
COPL	G 4 5	I A	-	55,35
COPL	G 4 5	N E	-	36,95

Cover Plate G50

SALTO XS4 Cover plate, for SALTO XS4 One Ex7xx handleset range.
 Made of steel. The set includes 2 plates (inside and outside)

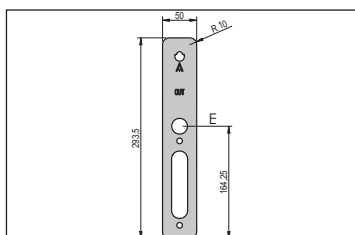

E= European axe handle.

Prices - Gross prices				€
Model	Width	Finish	Special plates	
COPL	G 5 0	I M	-	24,55
COPL	G 5 0	I P	-	27,65
COPL	G 5 0	P P	-	50,65
COPL	G 5 0	P M	-	50,65
COPL	G 5 0	I A	-	56,95
COPL	G 5 0	N E	-	38,45

Cover Plate G55

SALTO XS4 Cover plate, for SALTO XS4 One Ex7xx handleset range.
 Made of steel. The set includes 2 plates (inside and outside)

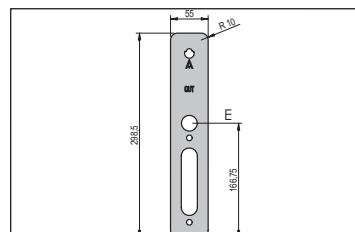

E= European axe handle.

Prices - Gross prices				€
Model	Width	Finish	Special plates	
COPL	G 5 5	I M	-	25,40
COPL	G 5 5	I P	-	28,45
COPL	G 5 5	P P	-	52,55
COPL	G 5 5	P M	-	52,55
COPL	G 5 5	I A	-	57,65
COPL	G 5 5	N E	-	39,00

Cover Plate G65

SALTO XS4 Cover plate, for SALTO XS4 One Ex7xx handleset range.
 Made of steel. The set includes 2 plates (inside and outside)

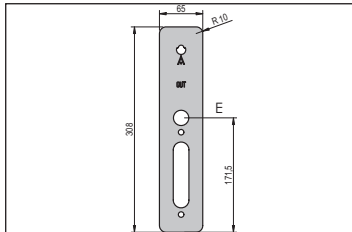

E= European axe handle.

Prices - Gross prices

Model	Width	Finish	Special plates
COPL	G 6 5	I M	-
COPL	G 6 5	I P	-
COPL	G 6 5	P P	-
COPL	G 6 5	P M	-
COPL	G 6 5	I A	-
COPL	G 6 5	N E	-

€
26,90
30,00
53,05
53,05
59,10
40,75

Cover Plate G75

SALTO XS4 Cover plate, for SALTO XS4 One Ex7xx handleset range.
 Made of steel. The set includes 2 plates (inside and outside)

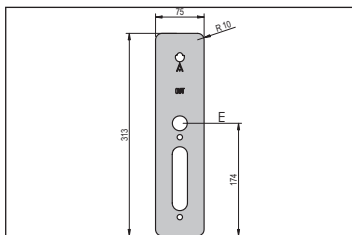

E= European axe handle.

Prices - Gross prices

Model	Width	Finish	Special plates
COPL	G 7 5	I M	-
COPL	G 7 5	I P	-
COPL	G 7 5	P P	-
COPL	G 7 5	P M	-
COPL	G 7 5	I A	-
COPL	G 7 5	N E	-

€
27,65
30,70
53,90
53,90
60,05
41,00

Cover Plate G85

SALTO XS4 Cover plate, for SALTO XS4 One Ex7xx handleset range.
 Made of steel. The set includes 2 plates (inside and outside)

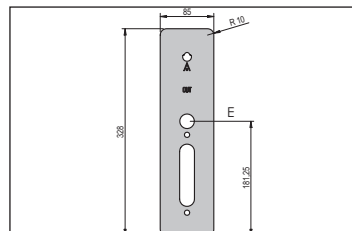

E= European axe handle.

Prices - Gross prices

Model	Width	Finish	Special plates
COPL	G 8 5	I M	-
COPL	G 8 5	I P	-
COPL	G 8 5	P P	-
COPL	G 8 5	P M	-
COPL	G 8 5	I A	-
COPL	G 8 5	N E	-

€
39,95
43,10
66,10
66,10
72,30
53,75

Cover Plate G90

SALTO XS4 Cover plate, for SALTO XS4 One Ex7xx handleset range.
 Made of steel. The set includes 2 plates (inside and outside)

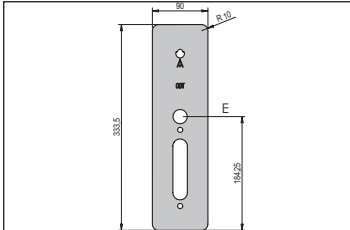

E= European axe handle.

Prices - Gross prices				€
Model	Width	Finish	Special plates	
COPL	G 9 0	I M	-	50,00
COPL	G 9 0	I P	-	52,80
COPL	G 9 0	P P	-	74,85
COPL	G 9 0	P M	-	74,85
COPL	G 9 0	I A	-	80,70
COPL	G 9 0	N E	-	63,10

Cover Plate G180S

SALTO XS4 Cover plate, for SALTO XS4 One Ex7xx handleset range.
 Made of steel. The set includes 2 plates (inside and outside)

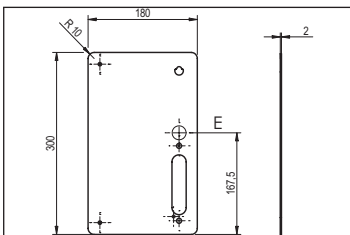

E= European axe handle.

Prices - Gross prices				€
Model	Width	Finish	Special plates	
COPL	G 1 8 0 S	I M	-	87,95

Cover Plate G180R

SALTO XS4 Cover plate, for SALTO XS4 One Ex7xx handleset range.
 Made of steel. The set includes 2 plates (inside and outside)

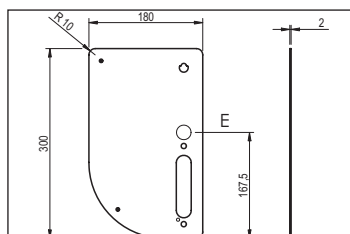

E= European axe handle.

Prices - Gross prices				€
Model	Width	Finish	Special plates	
COPL	G 1 8 0 R	I M	-	68,95

Custom cover plate Symmetrical ¹

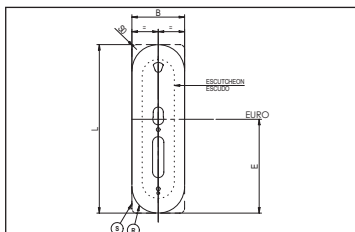

SALTO Symmetrical CUSTOM Cover-all Plates for SALTO XS4 EURO models.

Prices - Gross prices							€
Data required							
Symmetrical / Asymmetrical	Round / Special	Dimensions				Finish	Quantity requested
		L = High	B = Width	C = Center	E ³ =vert.aligmt		
Symmetrical	R Round	L	B	-	E ³	IM	-
	S ² Special					IP	
						PP	
						PM	
						IA	
			NE			Upon request	

Custom cover plate Asymmetrical ¹

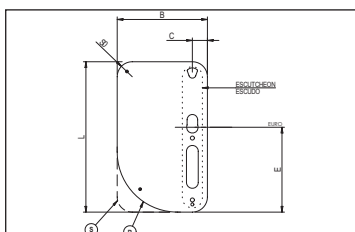

SALTO Asymmetrical CUSTOM Cover-all Plates for SALTO XS4 EURO models

Prices - Gross prices							€
Data required							
Symmetrical / Asymmetrical	Round / Special	Dimensions				Finish	Quantity requested
		L = High	B = Width	C = Center	E ³ =vert.aligmt		
Asymmetrical	R Round	L	B	C	E ³	IM	-
	S ² Special					IP	
						PP	
						PM	
						IA	
			NE			Upon request	

¹ SALTO reserves the right to accept or deny some requests .

² S must be detailed in mm. The minimum angle would be 2mm.

³ The E data is the vertical alignment from the bottom to the axe handle. If nothing is indicated we understand that the escutcheon will fit centrally in the plate.

For other special cover plates send a DXF or DWG file and SALTO will study the viability depending on the quantity, the finish and the design.

To request a special cover plate fill out this chart

SYMMETRICAL	ASYMMETRICAL	DIMENSIONS					QUANT.	FINISH
<input type="checkbox"/>	<input type="checkbox"/>	TYPE		L	B	C	*VERTICAL ALIGNEMENT	
S	R	E*						
		S0 (MIN=2mm)						

Remember the escutcheon dimensions

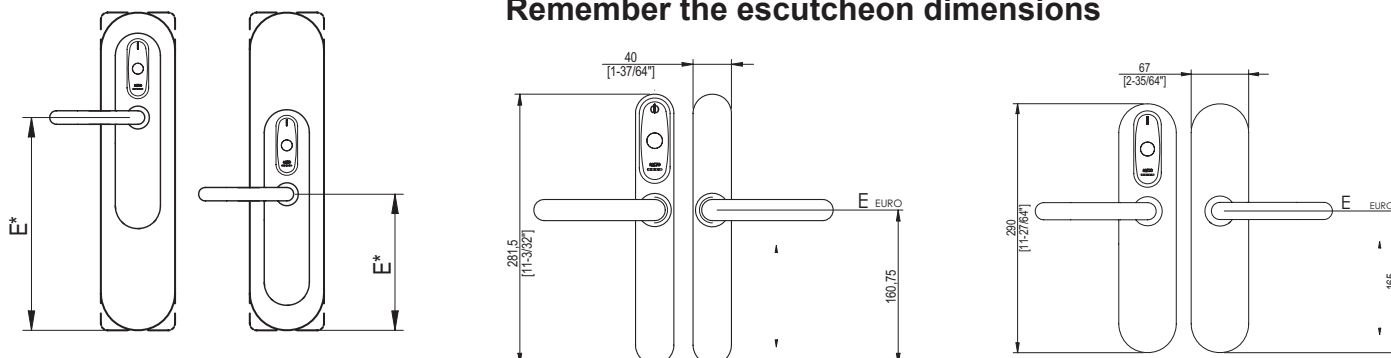

Custom cover plate Symmetrical¹ SALTO Symmetrical CUSTOM Cover-all Plates for SALTO XS4 Scandinavian models.

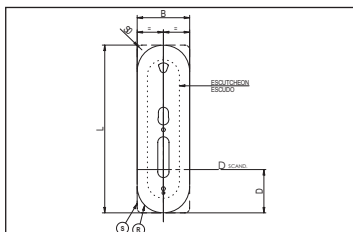

Prices - Gross prices							€
Data required							
Symmetrical / Asymmetrical	Round / Special	Dimensions				Finish	Quantity requested
		L = High	B = Width	C = Center	E ³ =vert.aligmt		
Symmetrical	R Round	L	B	-	E ³	IM	-
						IP	
	PP						
	PM						
	IA						
S ² Special						NE	
							Upon request

Custom cover plate Asymmetrical¹ SALTO Asymmetrical CUSTOM Cover-all Plates for SALTO XS4 Scandinavian models.

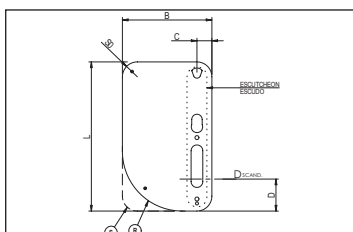

Prices - Gross prices							€
Data required							
Symmetrical / Asymmetrical	Round / Special	Dimensions				Finish	Quantity requested
		L = High	B = Width	C = Center	E ³ =vert.aligmt		
Asymmetrical	R Round	L	B	C	E ³	IM	-
						IP	
	PP						
	PM						
	IA						
S ² Special						NE	
							Upon request

¹ SALTO reserves the right to accept or deny some requests .

² S must be detailed in mm. The minimum angle would be 2mm.

³ The E data is the vertical alignment from the bottom to the axe handle. If nothing is indicated we understand that the escutcheon will fit centrally in the plate.

For other special cover plates send a DXF or DWG file and SALTO will study the viability depending on the quantity, the finish and the design.

To request a special cover plate fill out this chart

SYMMETRICAL	ASYMMETRICAL	DIMENSIONS				QUANT.	FINISH
<input type="checkbox"/>	<input type="checkbox"/>	TYPE		L	B	C	*VERTICAL ALIGNEMENT
		S	R				E*
		S0 (MIN=2mm)					

Remember the escutcheon dimensions

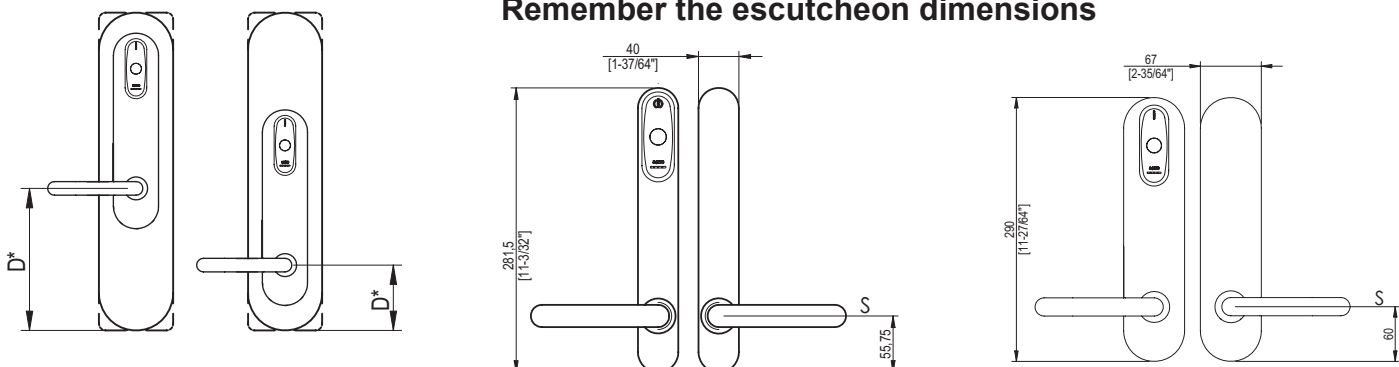

Custom cover plate Symmetrical ¹	SALTO Symmetrical CUSTOM Cover-all Plates for SALTO XS4 ANSI models.
--	--

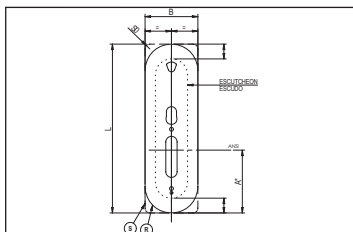

Prices - Gross prices							€
Data required							
Symmetrical / Asymmetrical	Round / Special	Dimensions				Finish	Quantity requested
		L = High	B = Width	C = Center	E ³ =vert.aligmt		
Symmetrical	R Round	L	B	-	E ³	IM	-
	S ² Special						
						IP	
						PP	
						PM	
		IA					
		NE					
Upon request							

Custom cover plate Asymmetrical ¹	SALTO Asymmetrical CUSTOM Cover-all Plates for SALTO XS4 ANSI models.
---	---

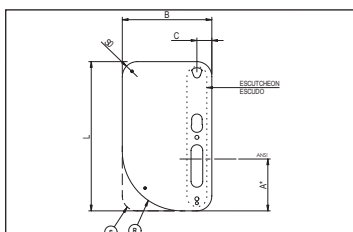

Prices - Gross prices							€
Data required							
Symmetrical / Asymmetrical	Round / Special	Dimensions				Finish	Quantity requested
		L = High	B = Width	C = Center	E ³ =vert.aligmt		
Asymmetrical	R Round	L	B	C	E ³	IM	-
	S ² Special						
						IP	
						PP	
						PM	
		IA					
		NE					
Upon request							

¹ SALTO reserves the right to accept or deny some requests .

² S must be detailed in mm. The minimum angle would be 2mm.

³ The E data is the vertical alignment from the bottom to the axe handle. If nothing is indicated we understand that the escutcheon will fit centrally in the plate.

For other special cover plates send a DXF or DWG file and SALTO will study the viability depending on the quantity, the finish and the design.

To request a special cover plate fill out this chart

SYMMETRICAL	ASYMMETRICAL	DIMENSIONS					QUANT.	FINISH	
<input type="checkbox"/>	<input type="checkbox"/>	TYPE		L	B	C	*VERTICAL ALIGNMENT		
		S	R				E*		
		S0 (MIN=2mm)							

Remember the escutcheon dimensions

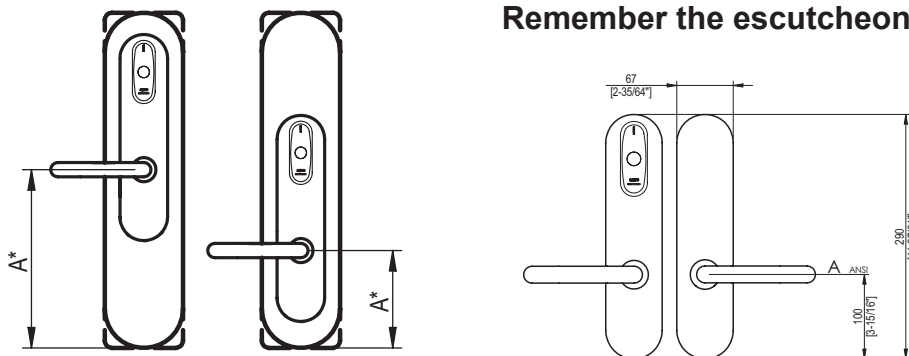

Mortise locks

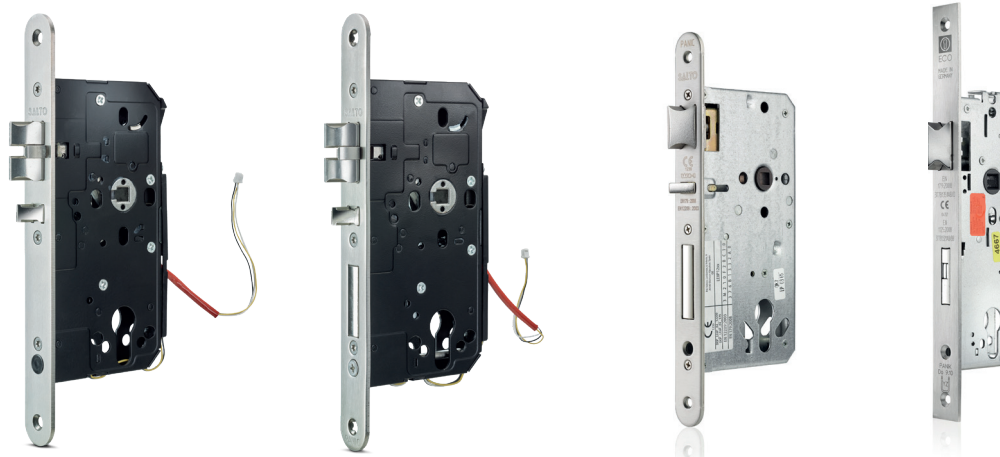

SALTO escutcheon reference example

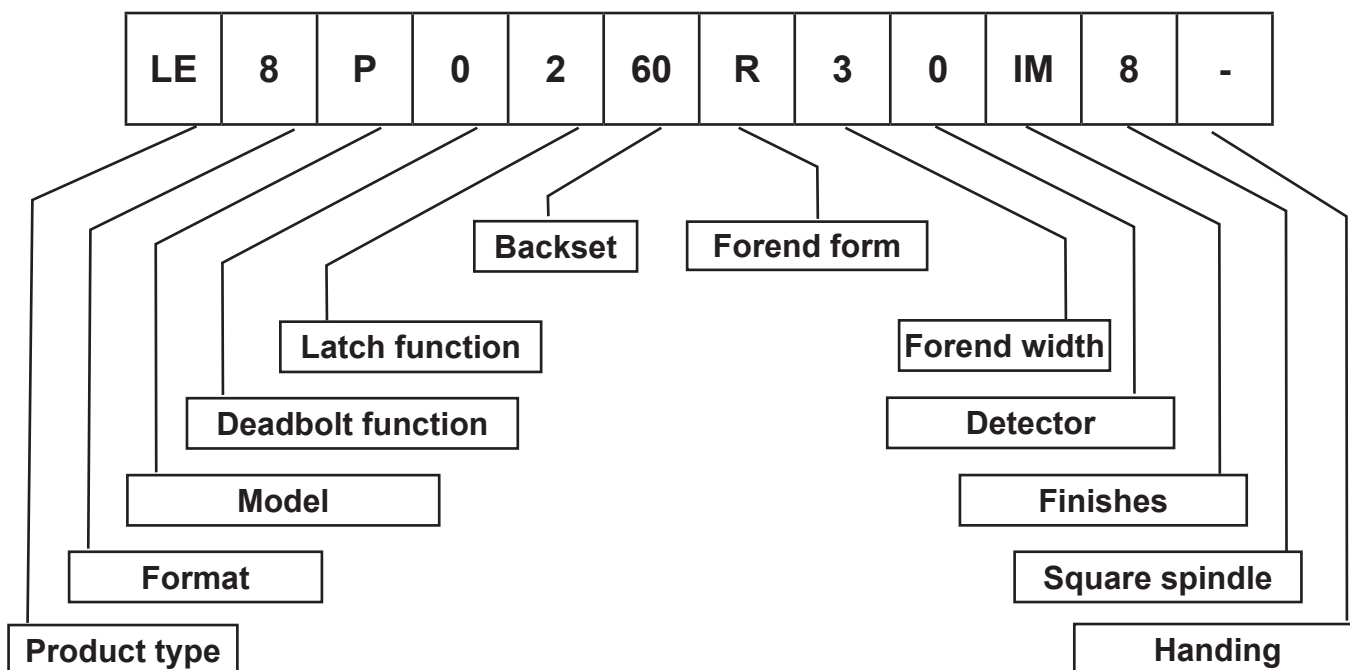

Product type:

LE = European lock
 LA = ANSI lock
 LC = Cartridge cylindrical latch

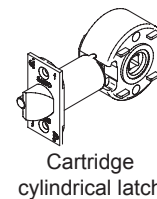
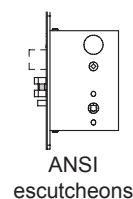
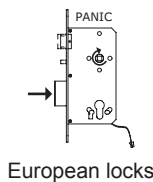

Format

8 = 85mm.
 7 = 72mm.
 9 = 92mm.
 1 = Gr 1 (only ANSI and cylindrical latches)
 2 = Gr 2 (only ANSI and cylindrical latches)

Models

P
 T
 W
 E
 S

Dead bolt function:

0 = Without deadbolt
 1 = Dead bolt + panic function
 2 = Dead bolt without panic function
 3 = Automatic deadbolt through

Latch function:

0 = Without latch
 1 = Normal latch
 2 = Latch through
 5 = Latch + mechanical anti friction

Mortise locks

Backset:

25 = 25mm	50 = 50mm	90 = 90mm
30 = 30mm	55 = 55mm	10 = 100mm
35 = 35mm	60 = 60mm	12 = 127mm
40 = 40mm	65 = 65mm	
45 = 45mm	70 = 70mm	

Foreend form:

R = Round
C = Squared
A = ANSI

Foreend width:

0 = 20mm
3 = 23mm
4 = 24mm
7 = 27mm
2 = 32mm

Detector:

0 = No detector
1 = deadbolt detector (privacy)
2 = door detector
3 = deadbolt detector (privacy) and door detector

Finishes:

IM = Stainless steel
EL = Gold enameled
LP = Polished brass (ANSI)

Square spindle:

8 = 8mm
9 = 9mm
S = 8mm split

V = 9mm split
D = Dual 8 squared and 7 diamond
(just for ANSI mortise locks)

Handing:

- = Reversible
L = Left handing
R = Right handing

HANDING SALTO lock door code

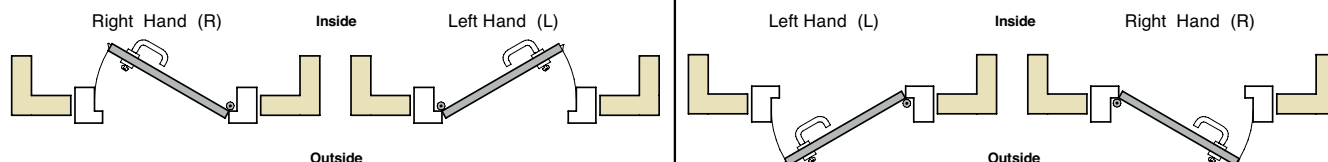

HANDING ANSI door lock code

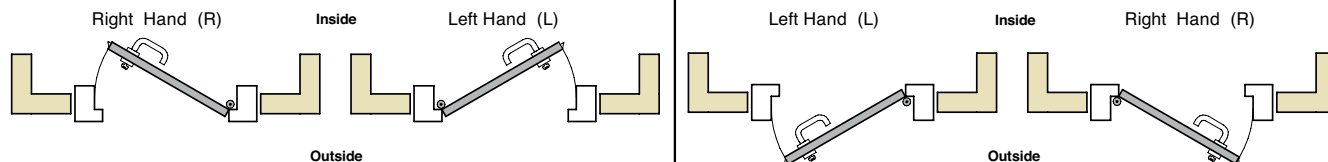

HANDING DIN lock door code (DIN 107 code)

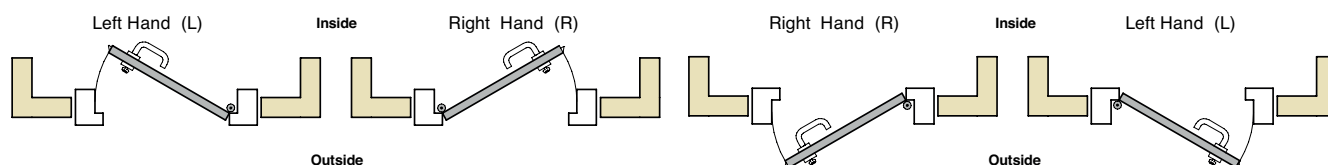

SALTO strike plates reference example

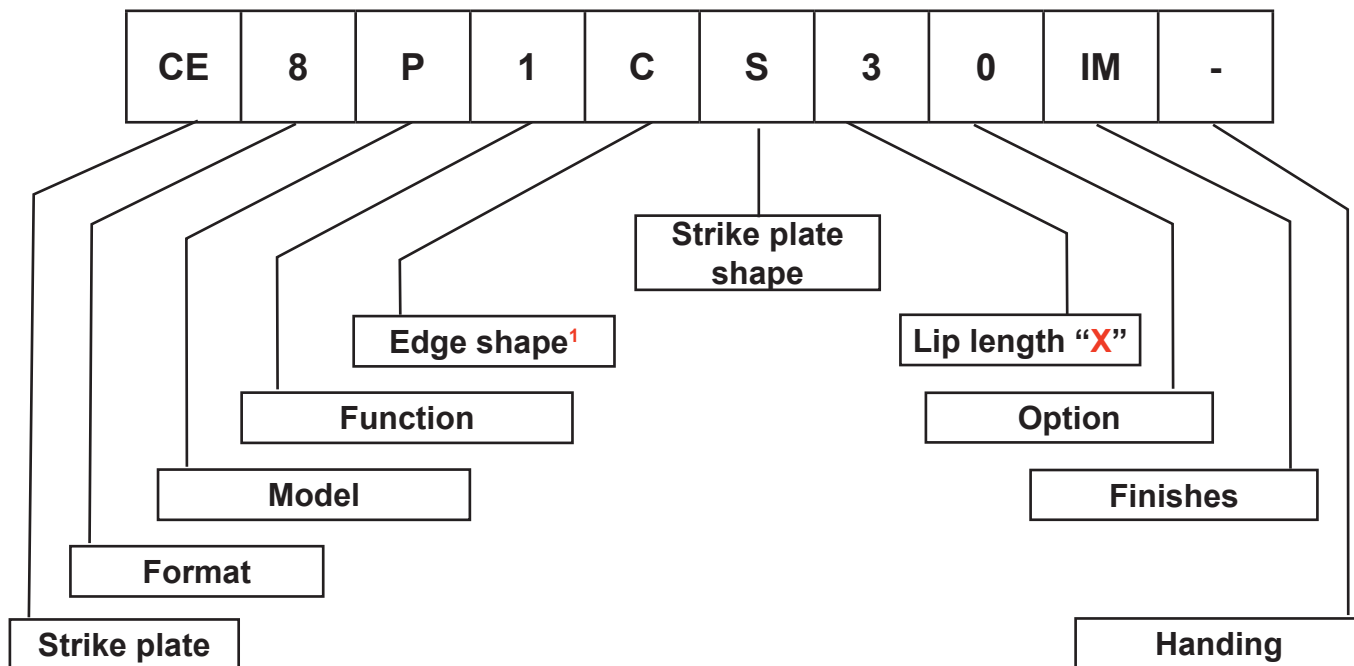

Format:

- 8 = 85mm
- 7 = 72mm
- 9 = 92mm
- 1 = Gr1 (only for ANSI locks)
- 2 = Gr2 (only for ANSI locks)

Model:

- P
- M
- W
- E
- S

Function:

- 0 = Without dead bolt just the latch
- 1 = Latch + dead bolt

Edge Shape :

- C = Squared
- R = Round
- A = ANSI

The A means ANSI shape. In special cases SALTO offers the option of a strike plate with an ANSI shape for European mortise locks. In this case the Lip length has a different meaning and values. See (2).

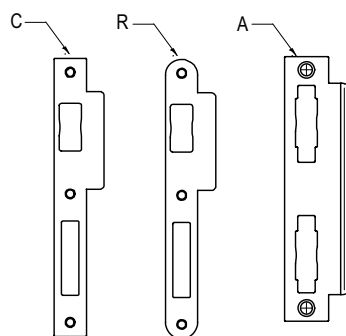

Strike plate shape:

- 0 = No lip
- S = Straight lip
- L = Curved lip
- E = Angled lip

Straight lips from the centre of the strike plate to the edge of the lip "X"
for european models

- 3 = 24mm
- 5 = 30mm
- 6 = 40mm

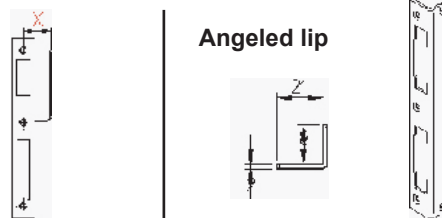

Curved lip length from the centre of the strike plate to the edge of the lip "X"

- for european models
- for ANSI models
- 5 = 30mm
- 3 = 32mm
- 6 = 40mm

For ANSI models for euro mortise locks:
2 = 35 mm.

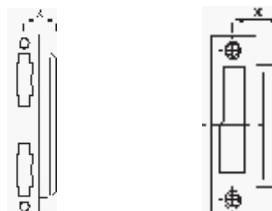

Model LE7S05

SALTO DIN compatible smart mortise lock with latch and anticard. (axe distance 72mm). Reversible latch and auxiliary latch device (anticard), NO deadbolt. The cylinder drives the latch. Smart built-in door detector optional.

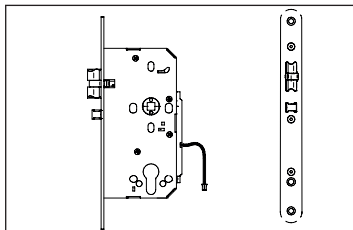

Mortise lock EN 12209 Grade 3 and EN 179 Grade 3 (combined with XS4 handle sets, U or H model handles) for use in busy, high traffic installations.

EN-1634 certified Ei 60.

Includes screws, strike plate and dust box for symmetrical strike plates models.

Screws in IM finish in any case.

Prices - Gross prices	€
LE7S05 mortise lock - No detectors - any finish	69,25
LE7S05 mortise lock - Built in door detector - any finish	95,85

Model	Backset	Front plate		Detector	Finish	Square spindle	Handing
		Shape	Size				
LE7S05	55	C Squared	0 20 mm symmetric	0 No detectors	IM	8	- reversible
	60		4 24 mm symmetric				
	65	R Round	T* asymmetric 20 mm	2 Door detector	EL	9	L* Left handing
	70		W* asymmetric 24 mm				R* Right handing



* Asymmetrical front plates T & W (for rebated doors) are handed and the handing needs to be detailed when ordering. Those locks don't include strike plate and dust box.

Model LE7S15

SALTO DIN compatible smart mortise lock with latch, anticard and deadbolt with panic function (axe distance 72mm). Reversible latch and auxiliary latch device (anti-card). The handle drives the deadbolt and the latch. Smart built-in door detector optional.

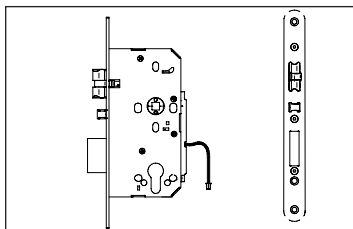

Mortise lock EN 12209 Grade 3 and EN 179 Grade 3 (combined with XS4 handle sets, U or H model handles) for use in busy, high traffic installations.

EN-1634 certified Ei 60.

Includes screws, strike plate and dust box for symmetrical strike plates models.

Screws in IM finish in any case.

Prices - Gross prices	€
LE7S15 mortise lock - No detectors - any finish	79,90
LE7S15 mortise lock - Built in privacy detector - any finish	90,55
LE7S15 mortise lock - Built in privacy and door detector - any finish	105,45

Model	Backset	Front plate		Detector	Finish	Square spindle	Handing
		Shape	Size				
LE7S15	55	C Squared	0 20 mm symmetric	0 No detectors	IM	8	- reversible
	60		4 24 mm symmetric				
	65	R Round	T* asymmetric 20 mm	1 Privacy detector	EL	9	L* Left handing
	70		W* asymmetric 24 mm	3 Privacy and door detector			R* Right handing



* Asymmetrical front plates T & W (for rebated doors) are handed and the handing needs to be detailed when ordering. Those locks don't include strike plate and dust box.

HANDING SALTO lock door code

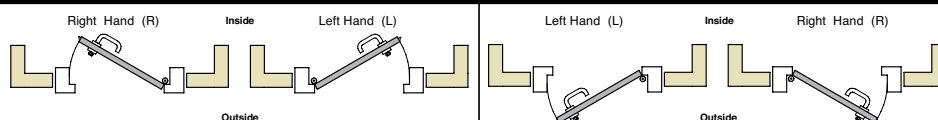

Model LE7S25

SALTO DIN compatible mortise lock with latch, anticard and deadbolt (axe distance 72mm). NO panic function. Reversible latch and auxiliar latch device (anticard). The handle drives the latch. and the cylinder drives the deadbolt and the latch.

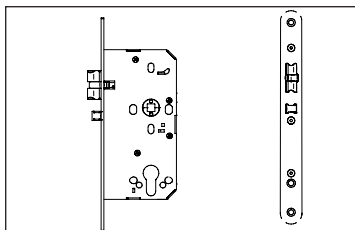

Prices - Gross prices	€
LE7S25 mortise lock - No detectors - any finish	79,90

Mortise lock EN 12209 Grade 3 and EN 179 Grade 3 (combined with XS4 handle sets, U or H model handles) for use in busy, high traffic installations.

EN-1634 certified Ei 60.

Includes screws, strike plate and dust box for symmetrical strike plates models.

Screws in IM finish in any case.

Model	Backset	Front plate		Detector	Finish	Square spindle	Handing
		Shape	Size				
LE7S25	55	C Squared	0 20 mm symmetric	0 No detectors	IM	8	- reversible
	60		4 24 mm symmetric				
	65	R Round	T* asymmetric 20 mm		EL	9	L* Left handing
	70		W* asymmetric 24 mm				R* Right handing



* Asymmetrical front plates T & W (for rebated doors) are handed and the handing needs to be detailed when ordering. Those locks don't include strike plate and dust box.

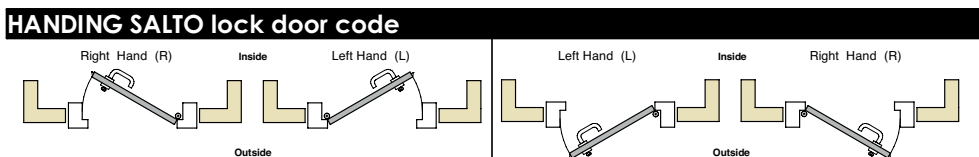

LE7S strike plates

Model CE7S0CSx0

SALTO Squared strike plate with straight lip for SALTO LE7S05 mortise locks. Strike plate for mortise lock with latch to be used with LE7S05 mortise locks. Does not include dust box and screws.

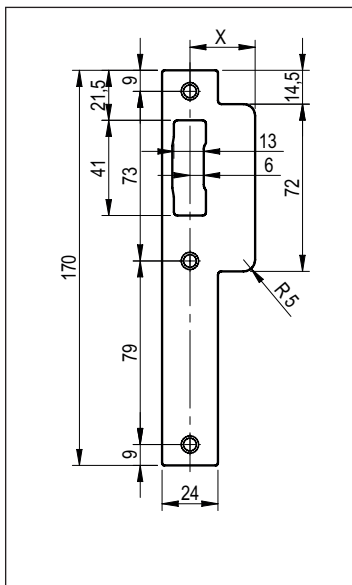

Prices - Gross prices								€
Reference	Model	Shape	Lip shape	Lip length "X"	Option	Finish	Handing	
CE7S	0 Latch	C Squared	S Straight	2* 20mm	0	IM Stainless steel	-	11,35
				3* 24,5mm				
				5 28mm standard				
				6* 38mm				
CE7S	0 Latch	C Squared	S Straight	2* 20mm	0	EL Gold enamel	-	20,75
				3* 24,5mm				
				5 28mm standard				
				6* 38mm				

* Price and delivery date can depend on the stock. Please consult SALTO.

Model CE7S1CSx0

SALTO Squared strike plate with straight lip for SALTO LE7S15 mortise locks. Strike plate for mortise lock with latch and deadbolt to be used with LE7S15 mortise locks. Does not include dust box and screws.

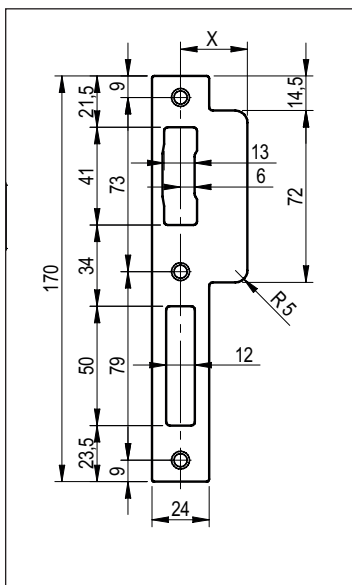

Prices - Gross prices								€
Reference	Model	Shape	Lip shape	Lip length "X"	Option	Finish	Handing	
CE7S	1 Latch & deadbolt	C Squared	S Straight	2* 20mm	0	IM Stainless steel	-	11,95
				3* 24,5mm				
				5 28mm standard				
				6* 38mm				
CE7S	1 Latch & deadbolt	C Squared	S Straight	2* 20mm	0	EL Gold enamel	-	21,35
				3* 24,5mm				
				5 28mm standard				
				6* 38mm				

* Price and delivery date can depend on the stock. Please consult SALTO.



Installation diagram for:
 CE7S0CS5;
 CE7S1CS5;
 CE7S0RS5;
 CE7S1RS5;

APPLICATION
Standard door

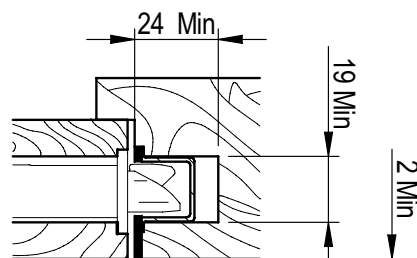

Model CE7S0RSx0

SALTO Round strike plate with straight lip for SALTO LE7S05 mortise locks.

Strike plate for mortise lock with latch to be used with LE7S05 mortise locks.

Does not include dust box and screws.

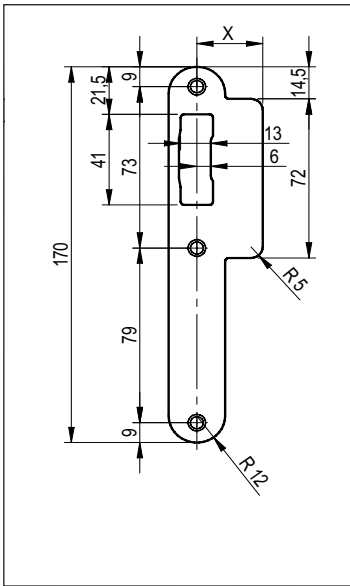

Prices - Gross prices								€	
Reference	Model	Shape	Lip shape	Lip length "X"	Option	Finish	Handing		
CE7S	0 Latch	R Round	S Straight	2*	0	IM Stainless steel	-	11,35	
				20mm					
				3*					24,5mm
				5					28mm
6*	38mm								
CE7S	0 Latch	R Round	S Straight	2*	0	EL Gold enamel	-	20,75	
				20mm					
				3*					24,5mm
				5					28mm
6*	38mm								

* Price and delivery date can depend on the stock. Please consult SALTO.

Model CE7S1RSx0

SALTO Round strike plate with straight lip for SALTO LE7S15 mortise locks.

Strike plate for mortise lock with latch and deadbolt to be used with LE7S15 mortise locks.

Does not include dust box and screws.

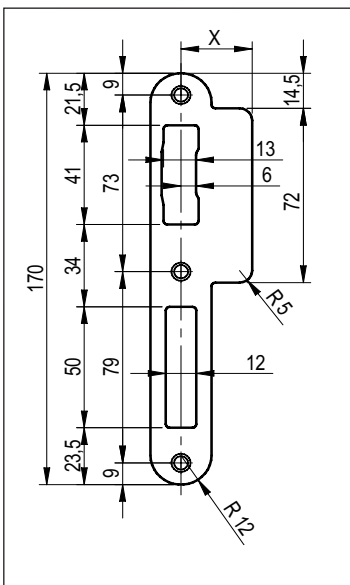

Prices - Gross prices								€	
Reference	Model	Shape	Lip shape	Lip length "X"	Option	Finish	Handing		
CE7S	1 Latch & deadbolt	R Round	S Straight	2*	0	IM Stainless steel	-	11,95	
				20mm					
				3*					24,5mm
				5					28mm
6*	38mm								
CE7S	1 Latch & deadbolt	R Round	S Straight	2*	0	EL Gold enamel	-	21,35	
				20mm					
				3*					24,5mm
				5					28mm
6*	38mm								

* Price and delivery date can depend on the stock. Please consult SALTO.



Installation diagram for:
 CE7S0CS5;
 CE7S1CS5;
 CE7S0RS5;
 CE7S1RS5;

APPLICATION
Standard door

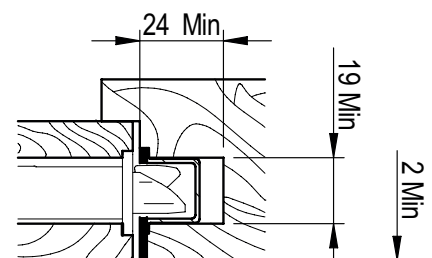

LE7S strike plates

Model CE7S0C000

SALTO Squared strike plate without lip for SALTO LE7S05 mortise locks.
Strike plate for mortise lock with latch to be used with LE7S05 mortise locks.
Includes dust box and screws.

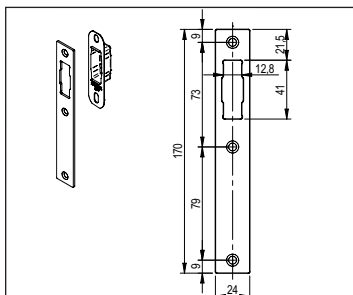

Prices - Gross prices								€
Reference	Model	Shape	Lip shape	Lip length "X"	Option	Finish	Handing	
CE7S	0 Latch	C Squared	0 No lip	0	0	IM Stainless steel	-	11,35
CE7S	0 Latch	C Squared	0 No lip	0	0	EL Gold enamel	-	20,75

Model CE7S1C000

SALTO Squared strike plate without lip for SALTO LE7S15 mortise locks.
Strike plate for mortise lock with latch and deadbolt to be used with LE7S15 mortise locks.
Includes dust box and screws.

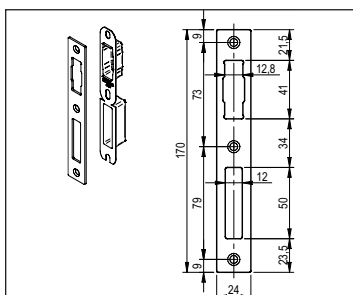

Prices - Gross prices								€
Reference	Model	Shape	Lip shape	Lip length "X"	Option	Finish	Handing	
CE7S	1 Latch & deadbolt	C Squared	0 No lip	0	0	IM Stainless steel	-	11,95
CE7S	1 Latch & deadbolt	C Squared	0 No lip	0	0	EL Gold enamel	-	21,35

Model CE7S0R000

SALTO Round strike plate without lip for SALTO LE7S05 mortise locks.
Strike plate for mortise lock with latch to be used with LE7S05 mortise locks.
Includes dust box and screws.

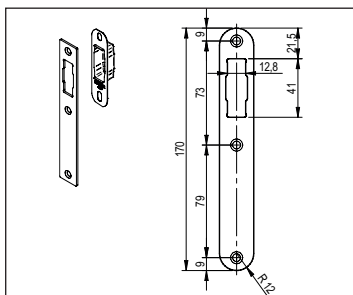

Prices - Gross prices								€
Reference	Model	Shape	Lip shape	Lip length "X"	Option	Finish	Handing	
CE7S	0 Latch	R Round	0 No lip	0	0	IM Stainless steel	-	11,35
CE7S	0 Latch	R Round	0 No lip	0	0	EL Gold enamel	-	20,75

Model CE7S1R000

SALTO Round strike plate without lip for SALTO LE7S15 mortise locks.
Strike plate for mortise lock with latch and deadbolt to be used with LE7S15 mortise locks.
Includes dust box and screws.

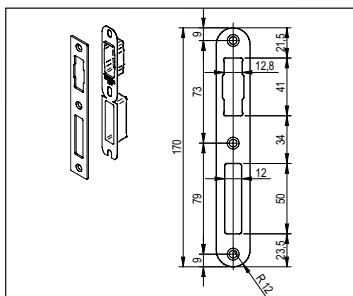

Prices - Gross prices								€
Reference	Model	Shape	Lip shape	Lip length "X"	Option	Finish	Handing	
CE7S	1 Latch & deadbolt	R Round	0 No lip	0	0	IM Stainless steel	-	11,95
CE7S	1 Latch & deadbolt	R Round	0 No lip	0	0	EL Gold enamel	-	21,35



Installation diagram for:
CE7S0C00;
CE7S1C00;
CE7S0R00;
CE7S1R00;

APPLICATION
Metal rebated door

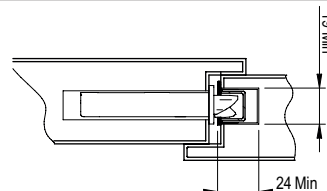

LE7S strike plates

Model CE7S0CLx0

SALTO Squared strike plate with curved lip for SALTO LE7S05 mortise locks.
Strike plate for mortise lock with latch to be used with LE7S05 mortise locks.
Does not include dust box and screws.

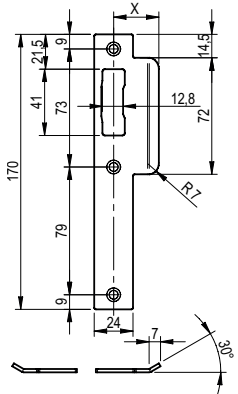

Prices - Gross prices								€
Reference	Model	Shape	Lip shape	Lip length "X"	Option	Finish	Handing	
CE7S	0 Latch	C Squared	L Curved lip	5 28mm standard	0	IM Stainless steel	L Left hand	11,90
				6* 38mm			R Right hand	
CE7S	0 Latch	C Squared	L Curved lip	5 28mm standard	0	EL Gold enamel	L Left hand	21,30
				6* 38mm			R Right hand	

* Price and delivery date can depend on the stock. Please consult SALTO.

Model CE7S1CLx0

SALTO Squared strike plate with curved lip for SALTO LE7S15 mortise locks.
Strike plate for mortise lock with latch and deadbolt to be used with LE7S15 mortise locks.
Does not include dust box and screws.

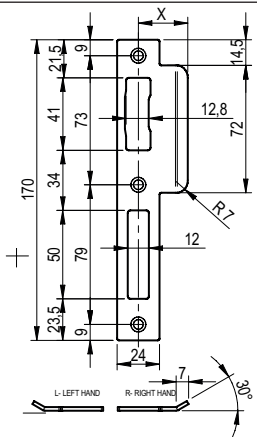

Prices - Gross prices								€
Reference	Model	Shape	Lip shape	Lip length "X"	Option	Finish	Handing	
CE7S	1 Latch & deadbolt	C Squared	L Curved lip	5 28mm standard	0	IM Stainless steel	L Left hand	12,55
				6* 38mm			R Right hand	
CE7S	1 Latch & deadbolt	C Squared	L Curved lip	5 28mm standard	0	EL Gold enamel	L Left hand	21,95
				6* 38mm			R Right hand	

* Price and delivery date can depend on the stock. Please consult SALTO.



Installation diagram for:
CE7S0CLO;
CE7S1CLO;
CE7S0RLO;
CE7S1RLO;

APPLICATION
Standard door

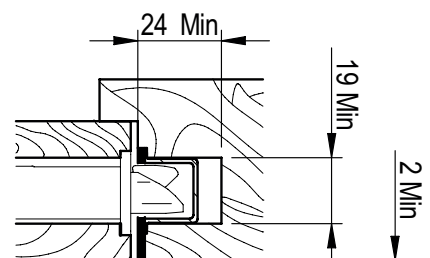

Model CE7S0RLx0

SALTO Round strike plate with curved lip for SALTO LE7S05 mortise locks.
Strike plate for mortise lock with latch to be used with LE7S05 mortise locks.
Does not include dust box and screws.

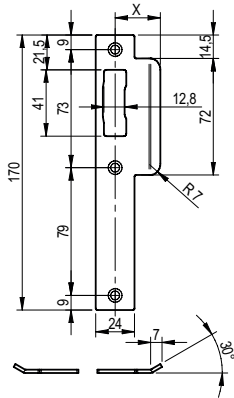

Prices - Gross prices								€
Reference	Model	Shape	Lip shape	Lip length "X"	Option	Finish	Handing	
CE7S	0 Latch	R Round	L Curved lip	5 28mm standard	0	IM Stainless steel	L Left hand	11,90
				6* 38mm			R Right hand	
CE7S	0 Latch	R Round	L Curved lip	5 28mm standard	0	EL Gold enamel	L Left hand	21,30
				6* 38mm			R Right hand	

* Price and delivery date can depend on the stock. Please consult SALTO.

Model CE7S1RLx0

SALTO Round strike plate with curved lip for SALTO LE7S15 mortise locks.
Strike plate for mortise lock with latch and deadbolt to be used with LE7S15 mortise locks.
Does not include dust box and screws.

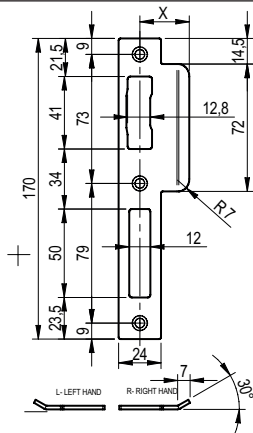

Prices - Gross prices								€
Reference	Model	Shape	Lip shape	Lip length "X"	Option	Finish	Handing	
CE7S	1 Latch & deadbolt	R Round	L Curved lip	5 28mm standard	0	IM Stainless steel	L Left hand	12,55
				6* 38mm			R Right hand	
CE7S	1 Latch & deadbolt	R Round	L Curved lip	5 28mm standard	0	EL Gold enamel	L Left hand	21,95
				6* 38mm			R Right hand	

* Price and delivery date can depend on the stock. Please consult SALTO.



Installation diagram for:
CE7S0CLO;
CE7S1CLO;
CE7S0RLO;
CE7S1RLO;

APPLICATION Standard door

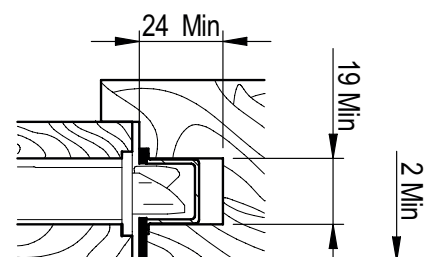

Model CE7S0CE0

SALTO Squared strike plate for rebated doors for SALTO LE7S05 mortise locks. Strike plate for mortise lock with latch to be used with LE7S05 mortise locks.

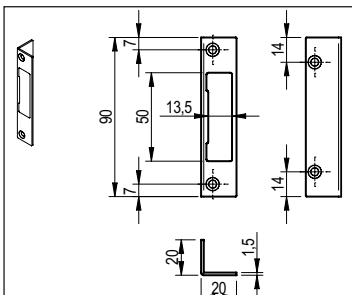

Prices - Gross prices								€
Reference	Model	Shape	Lip shape	Lip length "X"	Option	Finish	Handing	
CE7S	0 Latch	C Squared	E Angled	0	0	IM Stainless steel	-	28,75
CE7S	0 Latch	C Squared	E Angled	0	0	EL Gold enamel	-	43,20

Model CE7S1CE0

SALTO Squared strike plate for rebated doors for SALTO LE7S15 mortise locks. Strike plate for mortise lock with latch and deadbolt to be used with LE7S15 mortise locks.

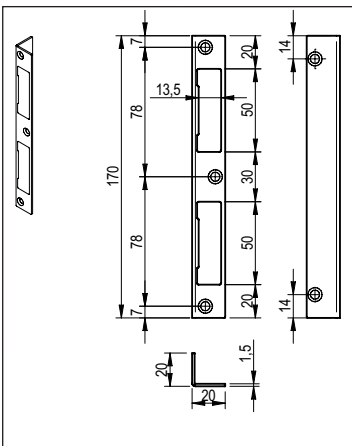

Prices - Gross prices								€
Reference	Model	Shape	Lip shape	Lip length "X"	Option	Finish	Handing	
CE7S	1 Latch & deadbolt	C Squared	E Angled	0	0	IM Stainless steel	-	28,75
CE7S	1 Latch & deadbolt	C Squared	E Angled	0	0	EL Gold enamel	-	43,20

Model CE7S0RE0

SALTO Round strike plate for rebated doors for SALTO LE7S05 mortise locks. Strike plate for mortise lock with latch to be used with LE7S05 mortise locks.

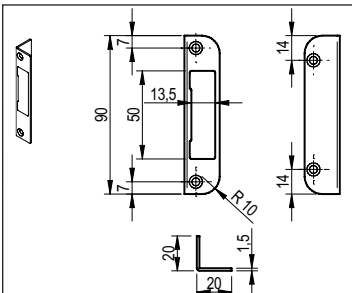

Prices - Gross prices								€
Reference	Model	Shape	Lip shape	Lip length "X"	Option	Finish	Handing	
CE7S	0 Latch	R Round	E Angled	0	0	IM Stainless steel	-	28,75
CE7S	0 Latch	R Round	E Angled	0	0	EL Gold enamel	-	43,20



Installation diagram for:
 CE7S0CE0;
 CE7S1CE0;
 CE7S0RE0;
 CE7S1RE0;

APPLICATION

Wooden rebated doors

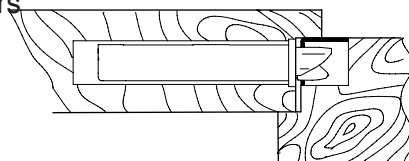

LE7S strike plates

Model CE7S1CE0

SALTO Round strike plate for rebated doors for SALTO LE7S15 mortise locks. Strike plate for mortise lock with latch and deadbolt to be used with LE7S15 mortise locks.

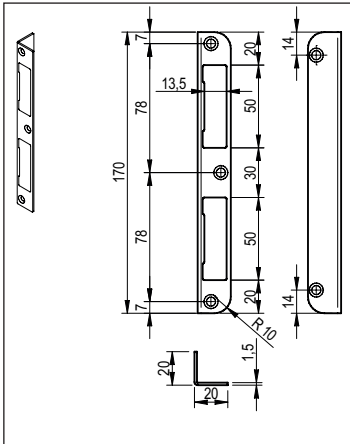

Prices - Gross prices								€
Reference	Model	Shape	Lip shape	Lip length "X"	Option	Finish	Handing	
CE7S	1 Latch & deadbolt	R Round	E Angled	0	0	IM Stainless steel	-	28,75
CE7S	1 Latch & deadbolt	R Round	E Angled	0	0	EL Gold enamel	-	43,20

Model CE7S0CB0

SALTO Squared strike plate for rebated doors with dust box for SALTO LE7S05 mortise locks. Strike plate for mortise lock with latch to be used with LE7S05 mortise locks. Includes dust box

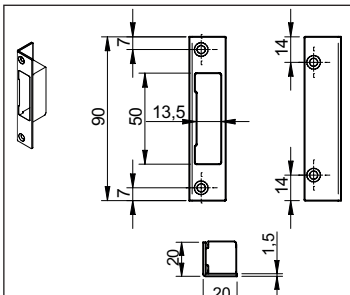

Prices - Gross prices								€
Reference	Model	Shape	Lip shape	Lip length "X"	Option	Finish	Handing	
CE7S	0 Latch	C Squared	B Angled with dust box	0	0	IM Stainless steel	-	28,75
CE7S	0 Latch	C Squared	B Angled with dust box	0	0	EL Gold enamel	-	43,20

Model CE7S1CB0

SALTO Squared strike plate for rebated doors with dust box for SALTO LE7S15 mortise locks. Strike plate for mortise lock with latch and deadbolt to be used with LE7S15 mortise locks. Includes dust box

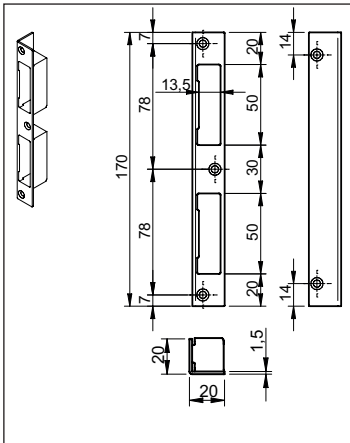

Prices - Gross prices								€
Reference	Model	Shape	Lip shape	Lip length "X"	Option	Finish	Handing	
CE7S	1 Latch & deadbolt	C Squared	B Angled with dust box	0	0	IM Stainless steel	-	28,75
CE7S	1 Latch & deadbolt	C Squared	B Angled with dust box	0	0	EL Gold enamel	-	43,20



Installation diagram for:
 CE7S0CE0;
 CE7S1CE0;
 CE7S0RE0;
 CE7S1RE0;

APPLICATION
 Wooden rebated doors

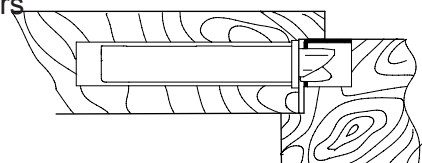

LE7S strike plates

Model CE7S0RB0

SALTO Round strike plate for rebated doors with dust box for SALTO LE7S05 mortise locks. Strike plate for mortise lock with latch to be used with LE7S05 mortise locks. Includes dust box

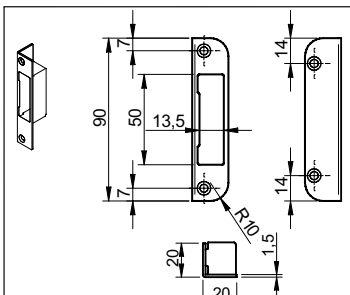

Prices - Gross prices

Reference	Model	Shape	Lip shape	Lip length "X"	Option	Finish	Handing	€
CE7S	0 Latch	R Round	B Angled with dust box	0	0	IM Stainless steel	-	28,75
CE7S	0 Latch	R Round	B Angled with dust box	0	0	EL Gold enamel	-	43,20

Model CE7S1RB0

SALTO Round strike plate for rebated doors with dust box for SALTO LE7S15 mortise locks. Strike plate for mortise lock with latch and deadbolt to be used with LE7S15 mortise locks. Includes dust box

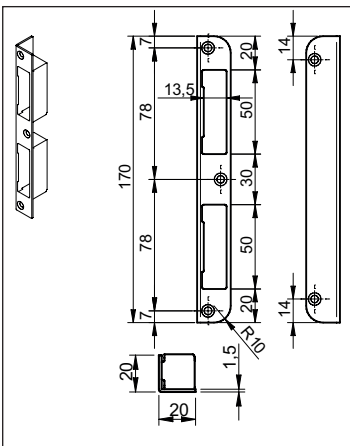

Prices - Gross prices

Reference	Model	Shape	Lip shape	Lip length "X"	Option	Finish	Handing	€
CE7S	1 Latch & deadbolt	R Round	B Angled with dust box	0	0	IM Stainless steel	-	28,75
CE7S	1 Latch & deadbolt	R Round	B Angled with dust box	0	0	EL Gold enamel	-	43,20



Installation diagram for:
CE7S0CE0;
CE7S1CE0;
CE7S0RE0;
CE7S1RE0;

APPLICATION

Wooden rebated doors

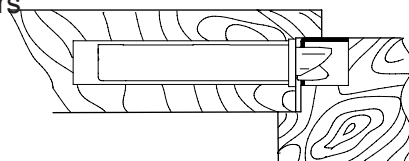

Model LE8P02

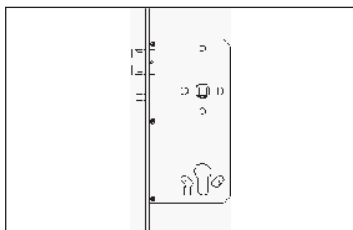

SALTO European mortise lock with projected latch. (axe distance 85mm). Only reversible projection latch, NO deadbolt. The cylinder drives the latch, reversible auxiliar latch device (anticard). The auxiliar latch (anticard) projects and deadlocks the latch.

Prices - Gross prices	€
Standard front plate price - any finish	38,80
ANSI front plate price - any finish	62,40

Mortise lock EN 12209 Grade 3 and EN 179 Grade 3 (combined with XS4 handle sets, U or H model handles) for use in busy, high traffic installations.

EN-1634 certificated Ei 60 and UL 90 in composite core door. Included screws in IM finish in any case.

Model	Backset	Front plate		Detector	Finish	Square spindle	Handing
		Shape	Size				
LE8P02	50	C Squared	0 20 mm	0 no detector	IM	8	- reversible
		R Round	3 23 mm				
	60	A ANSI type	7 27 mm				
			2 32 mm				
	70	A ANSI type	7 27 mm		EL		
			2 32 mm				

* Not all the front plate shapes and dimensions are possible. If the front plate shape is R (round) or C (squared) the size must be 0 (20mm.) or 3 (23mm.) If the front plate shape is A (ANSI type) the size must be 7 (27mm.) or 2 (32mm.).

Model LE8P12

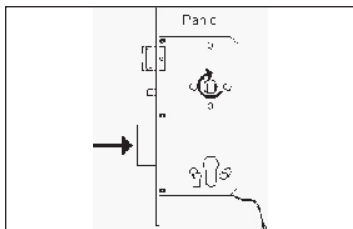

SALTO European mortise lock with projected latch and deadbolt. (axe distance 85mm). Steel mortise lock with reversible projection latch. The auxiliar latch (anticard) projects and deadlocks the latch and the lever retracts deadbolt and latch simultaneously (panic function).

Prices - Gross prices	€
Standard front plate price - any finish	53,30
ANSI front plate price - any finish	74,50

Mortise lock EN 12209 Grade 3 and EN 179 Grade 3 (combined with XS4 handle sets, U or H model handles) high frequency of use with little incentive to exercise care, public buildings. With Deadbolt detector (privacy detector).

EN-1634 certificated Ei 60 and UL 90 in composite core door. Included screws in IM finish in any case.

Model	Backset	Front plate		Detector	Finish	Square spindle	Handing
		Shape	Size				
LE8P12	50	C Squared	0 20 mm	1 Deadbolt detector (privacy)	IM	8	- reversible
		R Round	3 23 mm				
	60	A ANSI type	7 27 mm				
			2 32 mm				
	70	A ANSI type	7 27 mm		EL		
			2 32 mm				

* Not all the front plate shapes and dimensions are possible. If the front plate shape is R (round) or C (squared) the size must be 0 (20mm.) or 3 (23mm.) If the front plate shape is A (ANSI type) the size must be 7 (27mm.) or 2 (32mm.).

HANDING SALTO lock door code

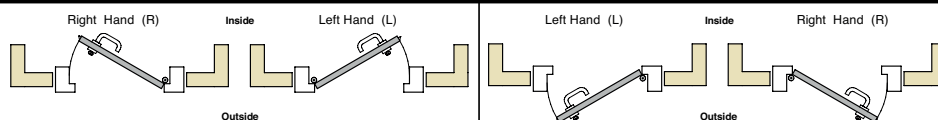

Model LE8P22

SALTO European mortise lock with projected latch and deadbolt. (axe distance 85mm). Reversible projection latch, deadbolt without panic function. The auxiliary latch (anticard) projects and deadlocks the latch and the lever retracts latch.

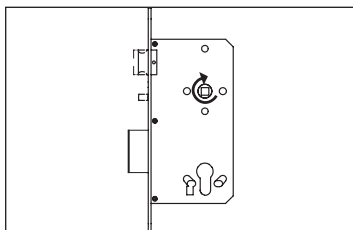

Prices - Gross prices	€
Standard front plate price - any finish	52,35
ANSI front plate price - any finish	73,55

Mortise lock EN 12209 Grade 3 for use in busy, high traffic installations.

EN-1634 certificated Ei 60 and UL 90 in composite core door. Included screws in IM finish in any case.

Model	Backset	Front plate		Detector	Finish	Square spindle	Handing
		Shape	Size				
LE8P22	50	C Squared	0 20 mm	0 no detector	IM	8	- reversible
			3 23 mm				
	60	R Round	7 27 mm				
			2 32 mm				
	70	A ANSI type					

 * Not all the front plate shapes and dimensions are possible. If the front plate shape is R (round) or C (squared) the size must be 0 (20mm.) or 3 (23mm.) If the front plate shape is A (ANSI type) the size must be 7 (27mm.) or 2 (32mm.)

HANDING SALTO lock door code

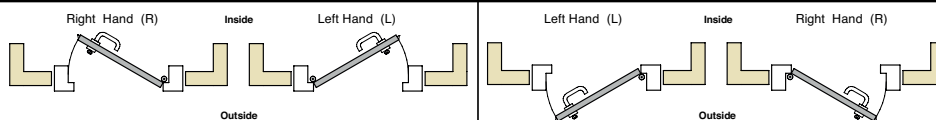

Model CE8P1CS3

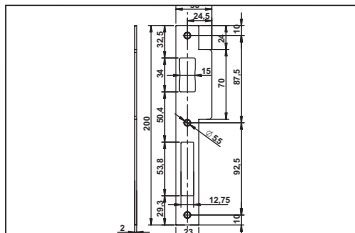

SALTO Squared strike plate with straight lip for SALTO.
For LE8P mortise lock series. Strike plate for mortise lock with latch and deadbolt to be used with LE8P12 and LE8P22 SALTO mortise locks. Includes dusbox.

Prices - Gross prices								€
Reference	Model	Shape	Lip shape	Lip length "X"	Option	Finish	Handing	
CE8P	1 Latch & deadbolt	C Squared	S Straight	3	0	IM Stainless steel	- reversible	4,65
CE8P	1 Latch & deadbolt	C Squared	S Straight	3	0	EL Gold enamel	- reversible	8,85

Model CE8P1RS3

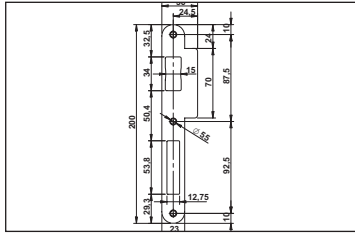

SALTO Round strike plate with straight lip for SALTO.
For LE8P mortise lock series. Strike plate for mortise lock with latch and deadbolt To be used with LE8P12 and LE8P22 SALTO mortise locks. Includes dusbox.

Prices - Gross prices								€
Reference	Model	Shape	Lip shape	Lip length "X"	Option	Finish	Handing	
CE8P	1 Latch & deadbolt	R Round	S Straight	3	0	IM Stainless steel	- reversible	4,65
CE8P	1 Latch & deadbolt	R Round	S Straight	3	0	EL Gold enamel	- reversible	8,85

Model CE8P0CS3

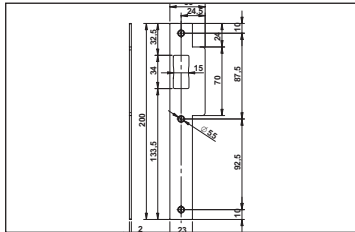

SALTO Squared strike plate with straight lip for SALTO .
LE8P mortise lock series. Strike plate for mortise lock with latch. To be used with LE8P02 SALTO mortise locks. Includes dusbox.

Prices - Gross prices								€
Reference	Model	Shape	Lip shape	Lip length "X"	Option	Finish	Handing	
CE8P	0 Latch	C Squared	S Straight	3	0	IM Stainless steel	- reversible	4,65
CE8P	0 Latch	C Squared	S Straight	3	0	EL Gold enamel	- reversible	8,85

Model CE8P0RS3

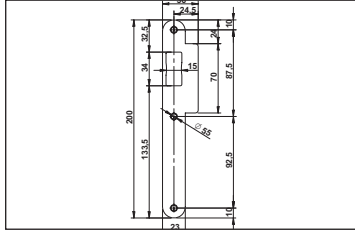

SALTO Round strike plate with straight lip for SALTO.
LE8P mortise lock series. Strike plate for mortise lock with latch. To be used with LE8P02 SALTO mortise locks. Includes dusbox.

Prices - Gross prices								€
Reference	Model	Shape	Lip shape	Lip length "X"	Option	Finish	Handing	
CE8P	0 Latch	R Round	S Straight	3	0	IM Stainless steel	- reversible	4,65
CE8P	0 Latch	R Round	S Straight	3	0	EL Gold enamel	- reversible	8,85

Installation diagram for:
CE8P1CS3;
CE8P1RS3;
CE8P0CS3;
CE8P0RS3;

APPLICATION:

STANDARD DOOR
* DOOR WIDTH CALCULATED FOR CENTERED LOCKS

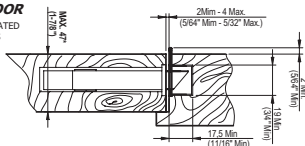

Model CE8P1C00

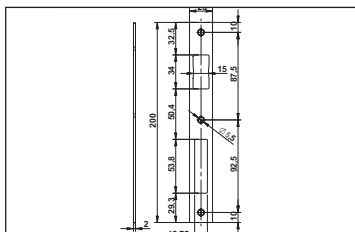

SALTO Squared strike plate without lip for SALTO. LE8P mortise lock series. Strike plate for mortise lock with latch and deadbolt SALTO mortise locks. To be used with LE8P12 and LE8P22 SALTO mortise locks. Includes dusbox.

Prices - Gross prices								€
Reference	Model	Shape	Lip shape	Lip length "X"	Option	Finish	Handing	
CE8P	1 Latch & deadbolt	C Squared	0 no lip	0	0	IM Stainless steel	- reversible	4,65
CE8P	1 Latch & deadbolt	C Squared	0 no lip	0	0	EL Gold enamel	- reversible	8,85

Model CE8P1R00

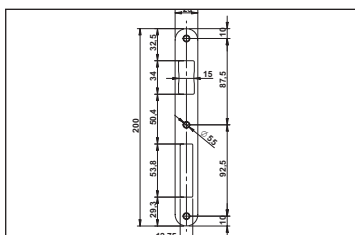

SALTO Round strike plate without lip for SALTO. LE8P mortise lock series. Strike plate for mortise lock with latch and deadbolt. To be used with LE8P12 and LE8P22 SALTO mortise locks. Includes dusbox.

Prices - Gross prices								€
Reference	Model	Shape	Lip shape	Lip length "X"	Option	Finish	Handing	
CE8P	1 Latch & deadbolt	R Round	0 no lip	0	0	IM Stainless steel	- reversible	4,65
CE8P	1 Latch & deadbolt	R Round	0 no lip	0	0	EL Gold enamel	- reversible	8,85

Model CE8P0C00

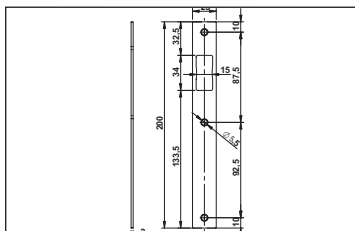

SALTO Round strike plate without lip for SALTO. For LE8P mortise lock series. Strike plate for mortise lock with latch. To be used with LE8P02 SALTO mortise locks. Includes dusbox.

Prices - Gross prices								€
Reference	Model	Shape	Lip shape	Lip length "X"	Option	Finish	Handing	
CE8P	0 Latch	C Squared	0 no lip	0	0	IM Stainless steel	- reversible	4,65
CE8P	0 Latch	C Squared	0 no lip	0	0	EL Gold enamel	- reversible	8,85

Model CE8P0R00

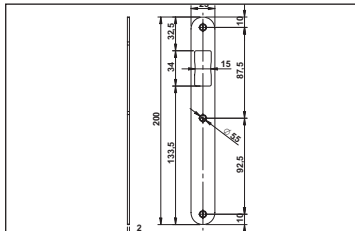

SALTO Round strike plate without lip for SALTO. For LE8P mortise lock series. Strike plate for mortise lock with latch. To be used with LE8P02 SALTO mortise locks. Includes dusbox.

Prices - Gross prices								€
Reference	Model	Shape	Lip shape	Lip length "X"	Option	Finish	Handing	
CE8P	0 Latch	R Round	0 no lip	0	0	IM Stainless steel	- reversible	4,65
CE8P	0 Latch	R Round	0 no lip	0	0	EL Gold enamel	- reversible	8,85

Installation diagram for:
 CE8P1C00;
 CE8P1R00;
 CE8P0C00
 CE8P0R00

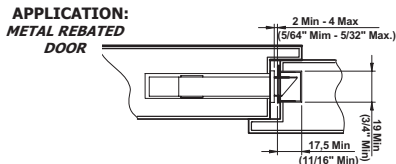

Model CE8P1CSx

SALTO Squared strike plate with lip for SALTO. LE8P mortise lock series. Strike plate for mortise lock with latch and deadbolt. to be used with LE8P12 and LE8P22 SALTO mortise locks. Includes dusbox.

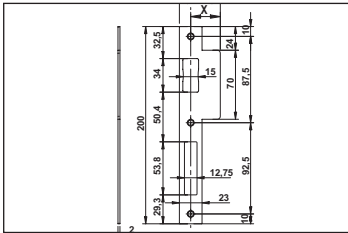

Prices - Gross prices								€
Reference	Model	Shape	Lip shape	Lip length "X"	Option	Finish	Handing	
CE8P	1 Latch & deadbolt	C Squared	S Straight	5 30mm	0	IM Stainless steel	- reversible	11,55
				6 40 mm				
CE8P	1 Latch & deadbolt	C Squared	S Straight	5 30mm	0	EL Gold enamel	- reversible	11,55
				6 40 mm				

Model CE8P1RSx

SALTO Round strike plate with lip for SALTO. LE8P mortise lock series. Strike plate for mortise lock with latch and deadbolt. To be used with LE8P12 and LE8P22 SALTO mortise locks. Includes dusbox.

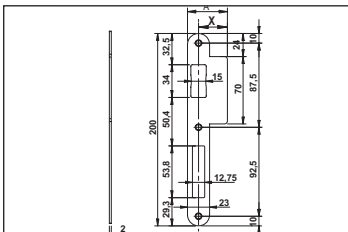

Prices - Gross prices								€
Reference	Model	Shape	Lip shape	Lip length "X"	Option	Finish	Handing	
CE8P	1 Latch & deadbolt	R Round	S Straight	5 30mm	0	IM Stainless steel	- reversible	11,55
				6 40 mm				
CE8P	1 Latch & deadbolt	R Round	S Straight	5 30mm	0	EL Gold enamel	- reversible	11,55
				6 40 mm				

Model CE8P0CSx

SALTO Squared strike plate with lip. LE8P mortise lock series. Strike plate for mortise lock with latch. To be used with LE8P02 SALTO mortise locks. Includes dusbox.

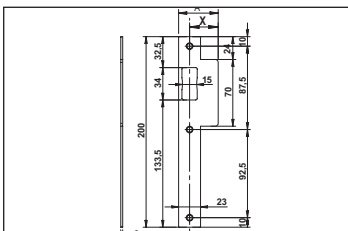

Prices - Gross prices								€
Reference	Model	Shape	Lip shape	Lip length "X"	Option	Finish	Handing	
CE8P	0 Latch	C Squared	S Straight	5 30mm	0	IM Stainless steel	- reversible	11,55
				6 40 mm				
CE8P	0 Latch	C Squared	S Straight	5 30mm	0	EL Gold enamel	- reversible	11,55
				6 40 mm				

Model CE8P0RSx

SALTO Round strike plate without lip. LE8P mortise lock series. Strike plate for mortise lock with latch. To be used with LE8P02 SALTO mortise locks. Includes dusbox.

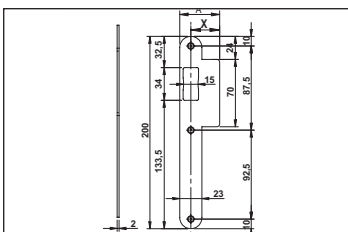

Prices - Gross prices								€
Reference	Model	Shape	Lip shape	Lip length "X"	Option	Finish	Handing	
CE8P	0 Latch	R Round	S Straight	5 30mm	0	IM Stainless steel	- reversible	11,55
				6 40 mm				
CE8P	0 Latch	R Round	S Straight	5 30mm	0	EL Gold enamel	- reversible	11,55
				6 40 mm				

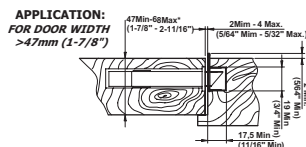

Installation diagram for:
CE8P1CS; CE8P1RS;
CE8P0CS and CE8P0RS

Model CE8P1CLx

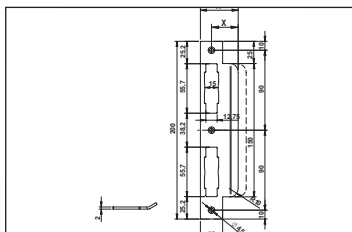

SALTO Squared strike plate with curved lip for SALTO LE8P mortise lock series. Strike plate for mortise lock with latch and deadbolt to be used with LE8Pxx SALTO mortise lock series. Can be fitted in right or left doors (reversible). Includes dusbox.

Prices - Gross prices								€
Reference	Model	Shape	Lip shape	Lip length "X"	Option	Finish	Handing	
CE8P	1 Latch & deadbolt	C Squared	L With lip	5 30mm	0	IM Stainless steel	- reversible	18,05
				6 40 mm				
CE8P	1 Latch & deadbolt	C Squared	L With lip	5 30mm	0	EL Gold enamel	- reversible	21,15
				6 40 mm				

Model CE8P1RLx

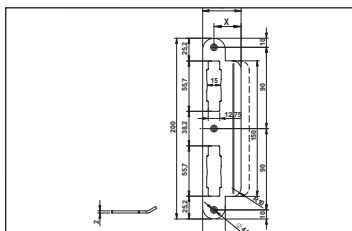

SALTO Round strike plate with curved lip for SALTO LE8P mortise lock series. Strike plate for mortise lock with latch and deadbolt to be used with LE8Pxx SALTO mortise lock series. Can be fitted in right or left doors (reversible). Includes dusbox.

Prices - Gross prices								€
Reference	Model	Shape	Lip shape	Lip length "X"	Option	Finish	Handing	
CE8P	1 Latch & deadbolt	R Round	L With lip	5 30mm	0	IM Stainless steel	- reversible	18,05
				6 40 mm				
CE8P	1 Latch & deadbolt	R Round	L With lip	5 30mm	0	EL Gold enamel	- reversible	21,15
				6 40 mm				

Model CE8P1AL2

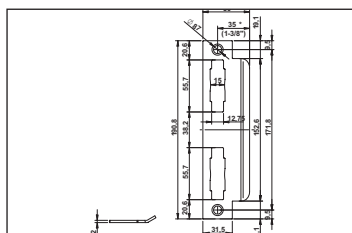

SALTO Squared ANSI strike plate with curved lip for SALTO LE8P mortise lock series. Strike plate for mortise lock with latch and deadbolt. For ANSI lock replacement, when we want to fit a European mortise lock. Reversible. Screws for metal and wood door and frames included. Includes dusbox.

Prices - Gross prices								€
Reference	Model	Shape	Lip shape	Lip length "X"	Option	Finish	Handing	
CE8P	1 Latch & deadbolt	A	L With lip	2	0	IM Stainless steel	- reversible	18,05
CE8P	1 Latch & deadbolt	A	L With lip	2	0	EL Gold enamel	- reversible	21,15

Model CE8P1CE0

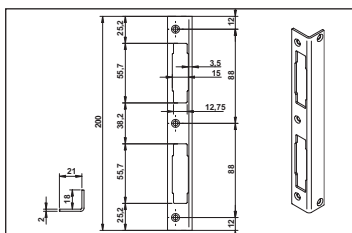

SALTO Squared strike plate without lip for SALTO LE8P mortise lock series. Strike plate for mortise lock with latch and deadbolt. To be used for wood rebated doors. Can be fitted in right or left doors (reversible). Includes dusbox.

Prices - Gross prices								€
Reference	Model	Shape	Lip shape	Lip length "X"	Option	Finish	Handing	
CE8P	1 Latch & deadbolt	C Squared	E With lip	0	0	IM Stainless steel	- reversible	18,05
CE8P	1 Latch & deadbolt	C Squared	E With lip	0	0	EL Gold enamel	- reversible	21,15

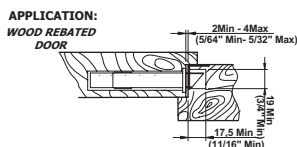

Model LE7W31

SALTO Automatic European mortise lock with steel deadlocking latch (anti card device) and deadbolt (axe distance 72mm, turning angle 30°).
The auxiliar latch (anticard) projects deadlock the deadbolt, and the lever retracts the deadbolt & latch.

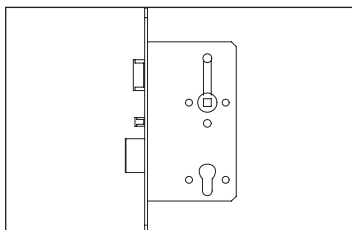

DIN 18250 mortise lock (axe distance 72mm).

For wooden doors.

Fire resistant version upon request.

For other backsets, spindles or front measures plates upon request.

Strike plate not included.

Prices - Gross prices	€
Standard price - any finish.	178,35

Model	Backset	Front plate		Detector	Finish	Square spindle	Handing
		Shape	Size				
LE7W31	60	C	4 24 mm	0 no detector	IM	8	R Right handing
							L Left handing

Model LE9W31

SALTO Automatic European mortise lock with steel deadlocking latch (anti card device) and deadbolt (axe distance 92mm, turning angle 30°).
The auxiliar latch (anticard) projects and deadlocks the deadbolt, and the lever retracts the deadbolt & latch.

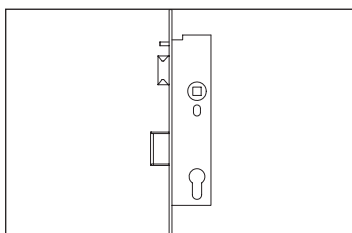

For metallic frame doors (92PZ).

Fire resistant version upon request.

Includes strike plate and 8 mm spindle adaptor.

Even if the 8mm squared spindle adaptor is included SALTO recommends to use with a 9mm squared spindle escutcheon.

Prices - Gross prices	€
Standard price - any finish.	455,15

Model	Backset	Front plate		Detector	Finish	Square spindle	Handing
		Shape	Size				
LE9W31	30	C	4 24 mm	0 no detector	IM	9	- reversible
	35						
	40						
	45						

HANDING DIN lock door code (DIN 107 code)

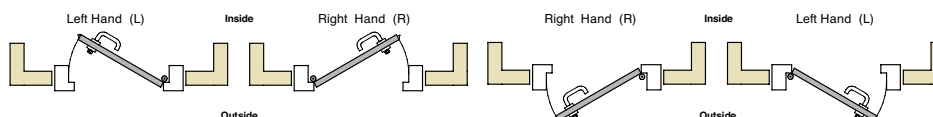

Model LE7E31

SALTO Automatic European mortise lock with steel deadlocking latch (anti card device) and deadbolt (axe distance 72mm, turning angle 50°).
The auxiliary latch (anticard) projects deadlock the deadbolt, and the lever retracts the deadbolt and latch.

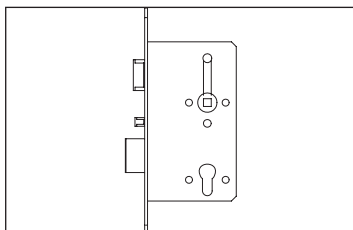

Prices - Gross prices	€
Standard price - any finish.	208,60

ECO Schulte GBS91C.

EN1125 compliant with PBE90 panic bar series (ECO Schulte EPN900) some SALTO XS4 handle sets and SALTO KP1 or 2 depending on the combination.

Check panic bar compatibilities chart on the SALTO panic bar price list.

Strike plate not included.

Model	Backset	Front plate		Detector	Finish	Square spindle	Handing
		Shape	Size				
LE7E31	55	R	0 20 mm	0 no detector	IM	9	R Right handing
	65		4 24 mm				L Left handing

Model LE9E11

SALTO European mortise lock with latch and deadbolt for profiled frame with panic function (axe distance 92mm, turning Angle 30°).
The lever retracts the deadbolt & latch.

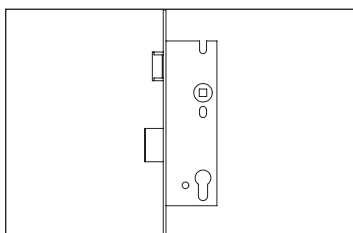

Prices - Gross prices	€
Standard price - any finish.	208,60

ECO Schulte GBS96C.

For metallic frame doors (92PZ)

Includes strike plate.

Check panic bar compatibilities chart on the SALTO panic bar price list.

Model	Backset	Front plate		Detector	Finish	Square spindle	Handing
		Shape	Size				
LE9E11	30	C	4 24 mm	0 no detector	IM	9	- Reversible
	35						
	40						
	45						

HANDING DIN lock door code (DIN 107 code)

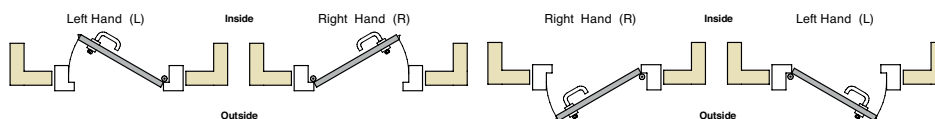

Model CE7W1CS50

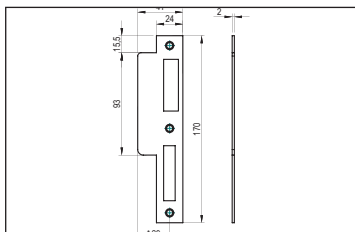

SALTO Squared strike plate with straight lip for SALTO automatic mortise lock series. Strike plate for mortise lock with latch and deadbolt. To be used with LE7W31 and LE7E31 SALTO mortise locks.

Prices - Gross prices								€
Reference	Model	Shape	Lip shape	Lip length "X"	Option	Finish	Handing	
CE7W	1 Latch & deadbolt	C Squared	S Straight	5	0	IM Stainless steel	- reversible	9,25

Model CE7W1RS50

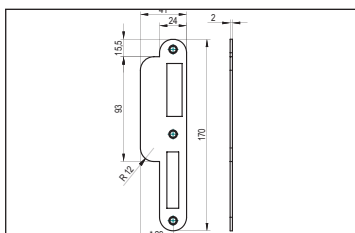

Round strike plate with straight lip rebated for SALTO automatic mortise lock series. Strike plate for mortise lock with latch and deadbolt. To be used with LE7W31 and LE7E31 SALTO mortise locks.

Prices - Gross prices								€
Reference	Model	Shape	Lip shape	Lip length "X"	Option	Finish	Handing	
CE7W	1 Latch & deadbolt	R Round	S Straight	5	0	IM Stainless steel	- reversible	9,25

Model CE7W1CE00

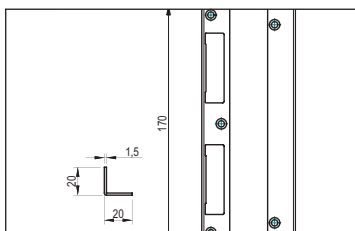

SALTO Squared strike plate with straight lip for rebated door for SALTO automatic mortise lock series. Strike plate for mortise lock with latch and deadbolt. To be used with LE7W31 and LE7E31 SALTO mortise locks. Can be fitted in right or left doors (reversible).

Prices - Gross prices								€
Reference	Model	Shape	Lip shape	Lip length "X"	Option	Finish	Handing	
CE7W	1 Latch & deadbolt	C Squared	E	0	0	IM Stainless steel	- reversible	9,25

Model CE7W1RE00

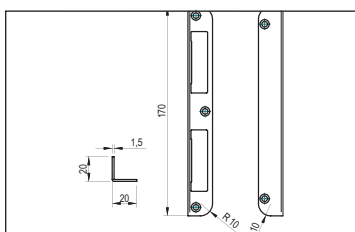

SALTO Round strike plate with straight lip for rebated door for SALTO automatic mortise lock series. Strike plate for mortise lock with latch and deadbolt. To be used with LE7W31 and LE7E31 SALTO mortise locks. Can be fitted in right or left doors (reversible).

Prices - Gross prices								€
Reference	Model	Shape	Lip shape	Lip length "X"	Option	Finish	Handing	
CE7W	1 Latch & deadbolt	R Round	E	0	0	IM Stainless steel	- reversible	9,25

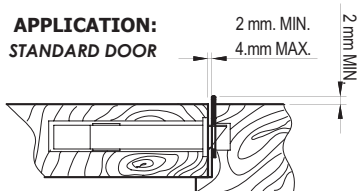

Installation diagram for the CE7W1CE00 and CE7W1RE00
For rebated doors

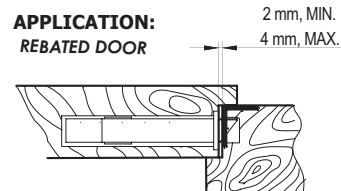

Model LA1T05

SALTO ANSI mortise lock with latch.
Auxiliar latch (anticard) deadlocks the latch

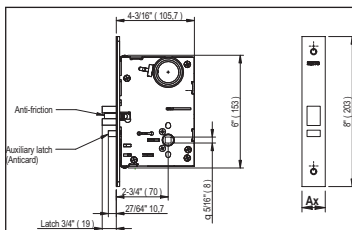

Stamped steel mortise lock with latch.
Reversible mortise lock, the handing can be changed on site.

ANSI A 156,13 Grade 1 - Heavy commercial, Institutional and industrial use.

UL Listed 3 hours rating.

Standard strike plate (reversible), dust box and screws included.

For other dimensions or options consult SALTO for availabilities

Prices - Gross prices

Standard price - any finish.

€

136,25

Model	Backset	Front plate		Detector	Finish	Square spindle	Handing
		Shape	Size				
LA1T05	70	A	7 27 mm	1 Door detector	IM standard	8 8mm	R Right handing
			2 32 mm standard		PM Satin brass		L Left handing

Model LA1T15

SALTO ANSI mortise lock with latch and deadbolt.
with panic function (axe distance 62mm).

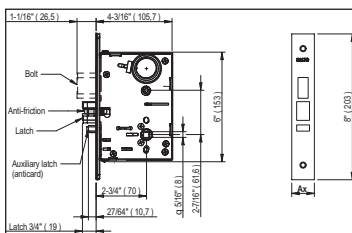

Stamped steel mortise lock with latch.
Reversible mortise lock, the handing can be changed on site.

ANSI A 156,13 Grade 1 - Heavy commercial, Institutional and industrial use.

UL Listed 3 hours rating.

Standard strike plate (reversible), dust box and screws included.

For other dimensions or options consult SALTO for availabilities

Prices - Gross prices

Standard price - any finish.

€

143,30

Model	Backset	Front plate		Detector	Finish	Square spindle	Handing
		Shape	Size				
LA1T15	70	A	7 27 mm	1 Door detector	IM standard	8 8mm	R Right handing
			2 32 mm standard		PM Satin brass		L Left handing

HANDING ANSI door lock code

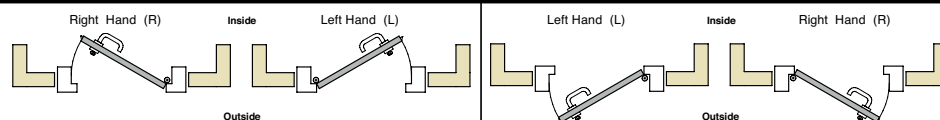
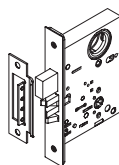
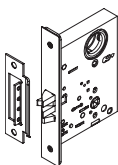

Model CE1T1AL

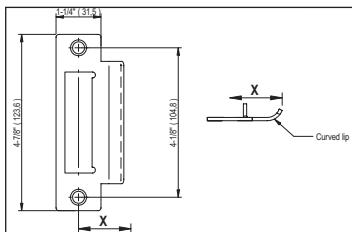

* Not in stock, consult SALTO for availability

SALTO Squared strike plate with lip for SALTO ANSI mortise locks.

To be used with LA1T0570 and LA1T1570 SALTO mortise locks. ANSI strike plate for mortise lock with latch or latch and deadbolt. Included with the mortise lock LA1T05 and LA1T15

Prices - Gross prices

Reference	Model	Shape	Lip shape	Lip length "X"	Option	Finish	Handing	€
CE1T	1 Latch & deadbolt	A ANSI	L Curved	3 X=32mm	0	IM Stainless steel	-	19,45
				8* X=38mm				
				4* X=44,5mm		PM Satin brass		
				5* X=51mm				

Model CE1T1AS

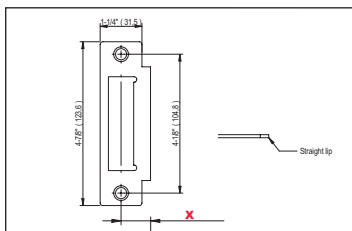

* Not in stock, consult SALTO for availability

SALTO Strike plate with straight lip for SALTO ANSI mortise locks.

To be used with LA1T0570 and LA1T1570 SALTO mortise locks. ANSI strike plate for mortise lock with latch or latch and deadbolt.

Prices - Gross prices

Reference	Model	Shape	Lip shape	Lip length "X"	Option	Finish	Handing	€
CE1T	1 Latch & deadbolt	A ANSI	S Straight	3 X=32mm	0	IM Stainless steel	-	19,45
				8* X=38mm				
				4* X=44,5mm		PM Satin brass		
				5* X=51mm				

Model CE1T1AL30IMh8

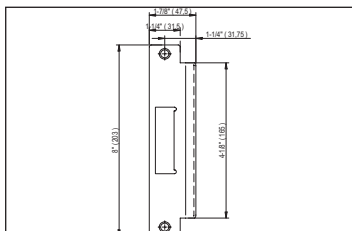

Not in stock, consult SALTO for availability

SALTO Special strike plate with curved lip for SALTO ANSI mortise locks.

To be used with LA1T0570 and LA1T1570 SALTO mortise locks. ANSI strike plate for mortise lock with latch or latch and deadbolt. Special length 203mm high (8").

Prices - Gross prices

Reference	Model	Shape	Lip shape	Lip length "X"	Option	Finish	Special	€
CE1T	1 Latch & deadbolt	A ANSI	L Curved	3 X=32mm	0	IM	8	19,45

Custom strike plate

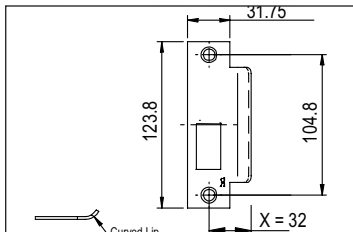

SALTO reserves the right to accept or deny any special ad-hoc strike plate request.

SALTO offers option of custom made strike plates.

If you are interested in custom made strike plates fill out the chart below detailing all the figures, then send the request to SALTO for approval.

Prices - Gross prices								€
Reference	Model	Shape	Lip shape	Lip length "X"	Option	Finish	Handing	
CE1T	1 Latch & deadbolt	A	X	X	X	X	X	19,45
						X	X	

CUSTOM STRIKE PLATES CHART Consult extra price

Items #	DIMENSION							LIP		HAND		HOLE TYPE		QUANTITY	FINISH
	A	B	X	D	E+	E-	F								
1															
2															
3															
4															
5															

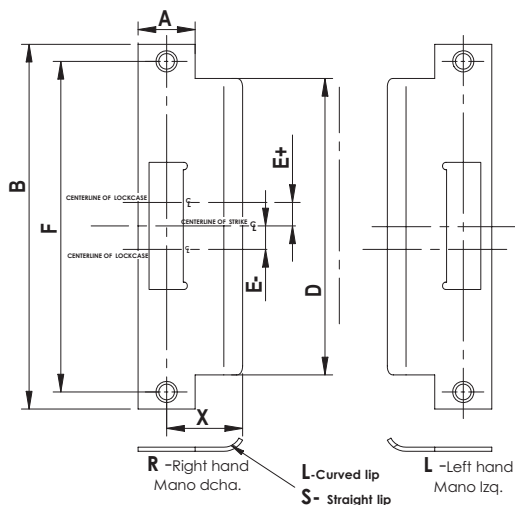

Model LC1K

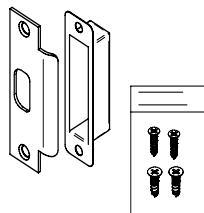
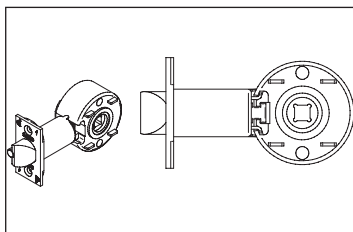

SALTO cylindrical latch grade 1.

ANSI A156.2 grade1. latch by lever either side. Auxiliar latch (anticard) deadlock the latch. Hub turning angle 58°. ASA strike, screws and dust box included.

Prices - Gross prices						€
Reference	Grade	Model	Front plate shape	Backset	Finish	
LC Cylindrical latch	1 Grade 1	K	C Squared	60 60mm - 2 3/8"	IM Satin stainless steel	95,75
					LP Polished brass	
LC Cylindrical latch	1 Grade 1	K	C Squared	70 70mm - 2 3/4"	IM Satin stainless steel	95,75
					LP Polished brass	
LC Cylindrical latch	1 Grade 1	K	C Squared	95 95mm - 3 3/4"	IM Satin stainless steel	104,45
					LP Polished brass	
LC Cylindrical latch	1 Grade 1	K	C Squared	27 127 mm - 5"	IM Satin stainless steel	104,45
					LP Polished brass	

Model LC2K

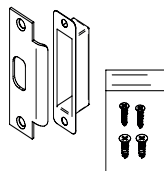
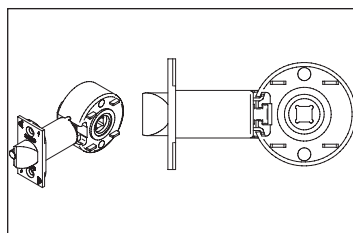

SALTO cylindrical latch grade 2.

ANSI A156.2 grade2. latch by lever either side. Auxiliar latch (anticard) deadlock the latch. Hub turning angle 58°. ASA strike, screws and dust box included.

Prices - Gross prices						€
Reference	Grade	Model	Front plate shape	Backset	Finish	
LC Cylindrical latch	2 Grade 2	K	C Squared	60 60mm - 2 3/8"	IM Satin stainless steel	95,75
					LP Polished brass	

Model 01848

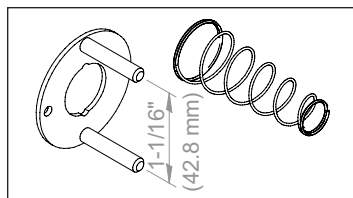

SALTO Cylindrical latch guiding support kit.

To be used when installed with Ax6xx or Ex6xxx SALTO escutcheons to fix the LCxK cylindrical latch.

Prices - Gross prices		€
Description	Reference	
SALTO Cylindrical latch guiding support kit.	0 1 8 4 8	9,20

Model CELTKA

SALTO ASA strike plate with lip for SALTO LCxK cylindrical latches.
To be used with LC1KC and LC1KC SALTO cylindrical latch.
Includes dust box and screws.

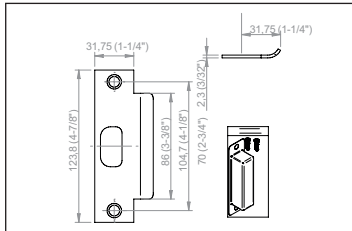

Prices - Gross prices				€
Reference	Model	Shape	Finish	
CELT	K	A ASA type	IM Stainless steel	19,45
			LP Polished brass	

Model CELTKT

SALTO T strike plate with lip for SALTO LCxK cylindrical latches.
To be used with LC1KC and LC1KC SALTO cylindrical latch.
Includes dust box and screws.

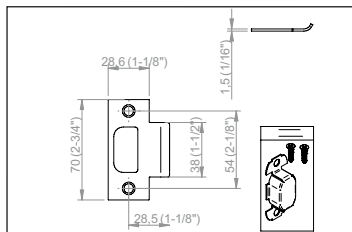

Prices - Gross prices				€
Reference	Model	Shape	Finish	
CELT	K	T T type	IM Stainless steel	19,45
			LP Polished brass	

Model CELTKL

SALTO LIP strike plate with lip for SALTO LCxK cylindrical latches.
To be used with LC1KC and LC1KC SALTO cylindrical latch.
Includes screws.

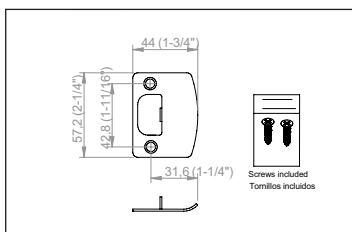

Prices - Gross prices				€
Reference	Model	Shape	Finish	
CELT	K	L LIP type	IM Stainless steel	19,45
			LP Polished brass	

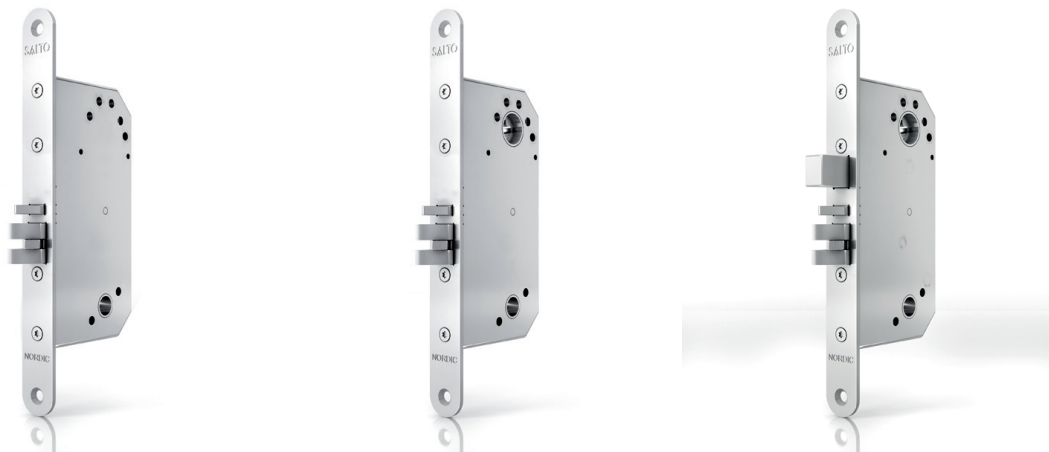

SALTO escutcheon reference example

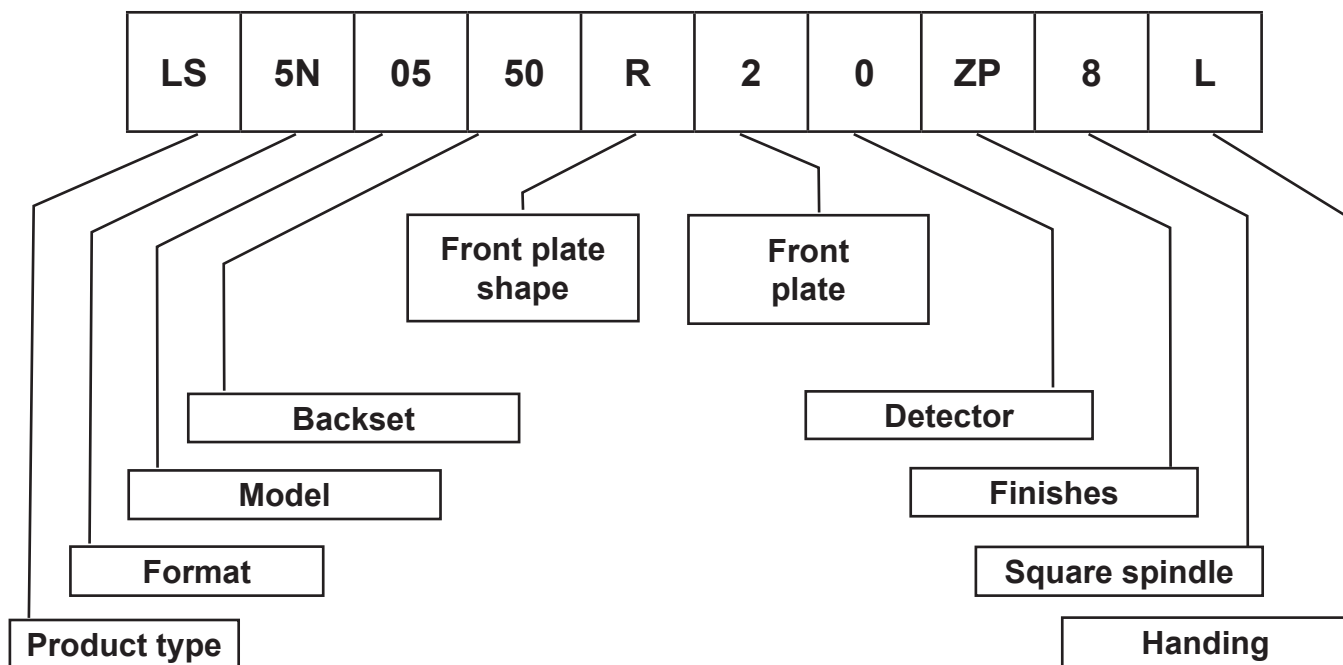

Product type:

- LS = Lock Scandinavian
- LE = European lock
- LA = ANSI lock
- LC = Cartridge cylindrical latch

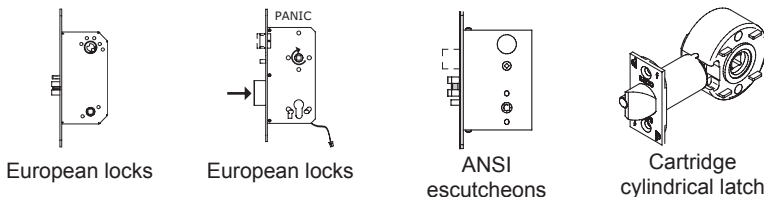

Format

5N = Standard dimensions according to SIS 817383

Models

- 04 = Self locking latch lock
- 05 = Self locking latch lock with cylinder option
- 15 = Self locking latch lock with deadbolt (panic function)
- 25 = Self locking latch lock with deadbolt

Backset:

50 = 50mm

Front plate shape:

R = Round

Front plate

2 = 22mm

Detector:

- 0 = No detector
- 1 = Door detector
- 2 = Door detector+ deadbolt detector

Finish:

ZP = Zinc plated

Square spindle:

8 = 8mm

Handing:

- = Reversible
- L = Left handing
- R = Right handing

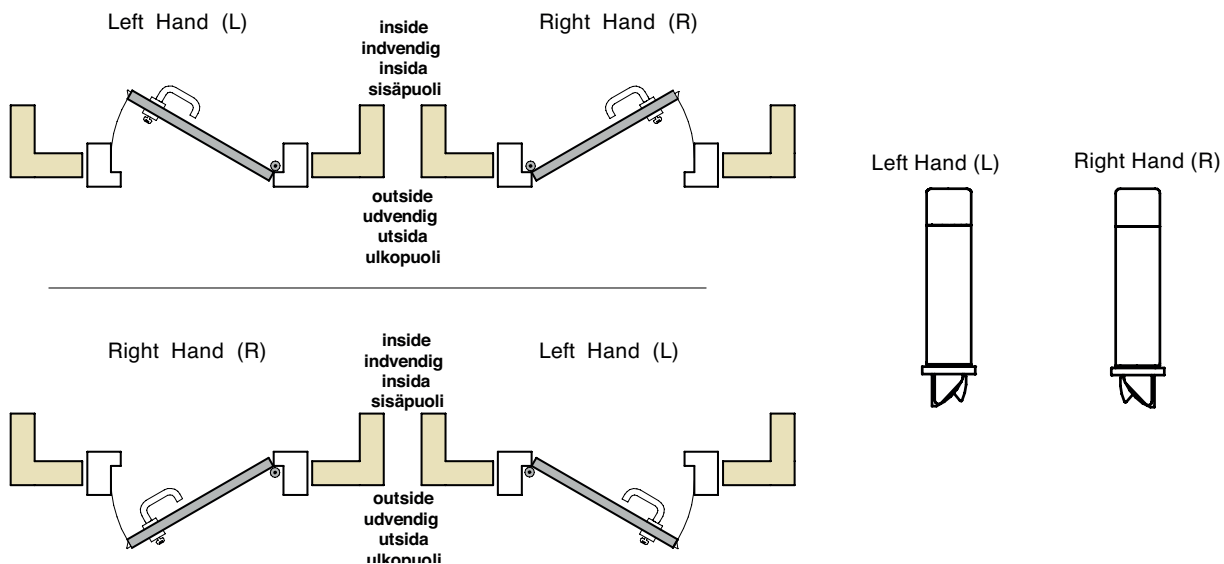

Model LS5N04

SALTO Scandinavian mortise lock
Self locking latch lock, Blocking mechanism through anti card protection.
For opening turn the level handle down.

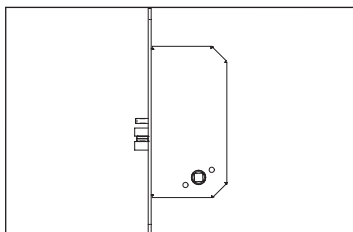

Prices - Gross prices	€
Model with no detectors - Standard price	54,80

Product type serie	Model	Backset	Front plate shape	Front plate	Detector	Finish	Square spindle	Handing
LS5N	04	50 50 mm	R Round	2 20mm	0 no detector	ZP Zinc Plated	8 8mm	L Left hand
								R Right hand

Model LS5N05

SALTO Scandinavian mortise lock
Self locking latch lock, Blocking mechanism through anti card protection.
For opening the latches can operated by key 90° For opening turn the level handle down

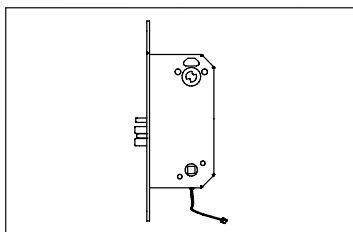

Prices - Gross prices	€
Model with no detectors - Standard price	66,85
Model with door detector - Standard price	93,40

Product type serie	Model	Backset	Front plate shape	Front plate	Detector	Finish	Square spindle	Handing
LS5N	05	50 50 mm	R Round	2 20mm	0 no detector	ZP Zinc Plated	8 8mm	L Left hand
					1 Door detector			R Right hand

Model LS5N15

SALTO Scandinavian mortise lock with deadbolt and panic function
Self locking latch lock, Blocking mechanism through anti card protection.
The latches can be operated by key or thumbturn 90°. For opening turn the handle down.

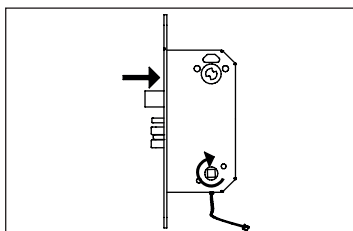

Prices - Gross prices	€
Model with no detectors - Standard price	71,60
Model with door and deadbolt detector - Standard price	111,90

Product type serie	Model	Backset	Front plate shape	Front plate	Detector	Finish	Square spindle	Handing
LS5N	15	50 50 mm	R Round	2 20mm	0 no detector	ZP Zinc Plated	8 8mm	L Left hand
					2 Door and deadbolt detector			R Right hand

Model LS5N25

SALTO Scandinavian mortise lock. Self locking latch lock, Blocking mechanism through anti card protection. No panic function. For opening retrieve the latch with a key or thumbturn turn and pull the handle down.

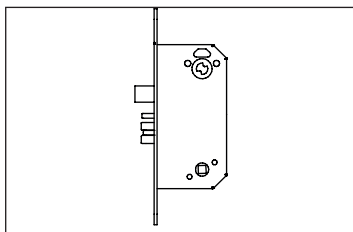

Prices - Gross prices	€
Model with no detectors - Standard price	71,60

Product type serie	Model	Backset	Front plate shape	Front plate	Detector	Finish	Square spindle	Handing
LS5N	25	50 50 mm	R Round	2 20mm	0 no detector	ZP Zinc Plated	8 8mm	L Left hand
								R Right hand

Model CE5N1R000ZP

SALTO high security strike plate for Scandinavian mortise lock. Reversible strike plate with adjustable system.

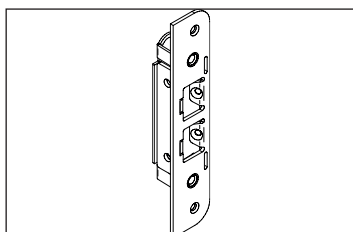

Prices - Gross prices	€
Strike plate - Standard price	21,40

Reference	Model	Shape	Lip shape	Lip length "x"	Option	Finish	Handing
CE5N	1 Latch & deadbolt	R Round	0 No Lip	0	0	ZP Zinc Plated	- reversible

Handing:

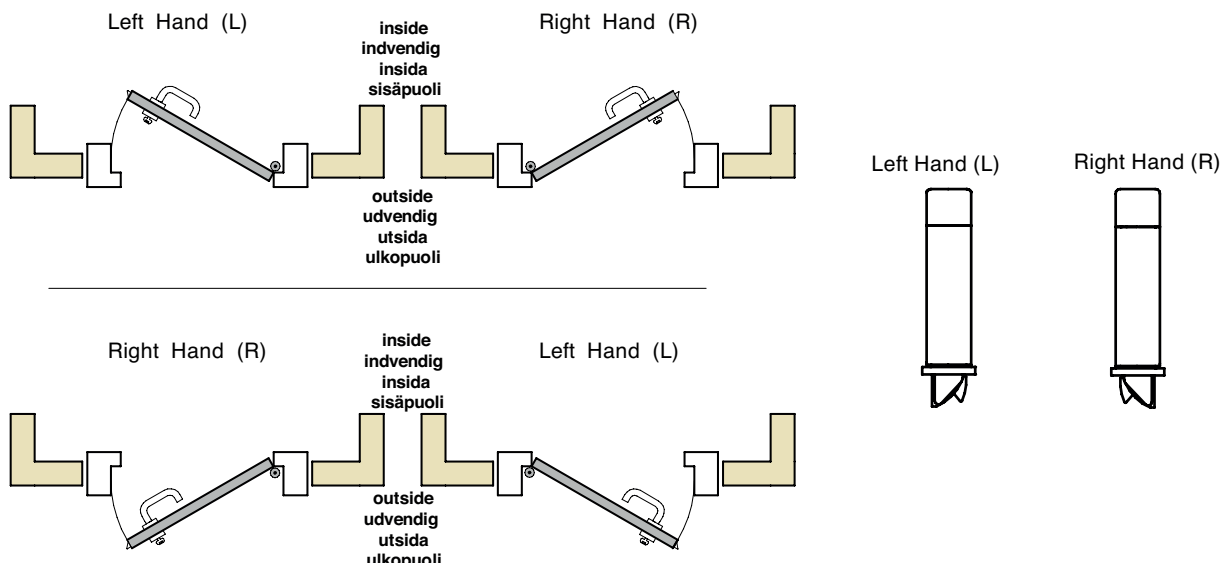

Wall readers



Model WRM7000

SALTO Modular Wall Reader.

To be used with CU50EN and/or CU50ENSVN. Includes concealed fixing covers.
! Excludes fixing base that needs to be purchased separately.



Prices - Gross prices		€
Description	Reference	
WRM Proximity Picopass for online control units	W R M 7 0 0 0	315,55

Model WRM7001

SALTO Modular Wall Reader.

To be used with CU5000, CU50EN and/or CU50ENSVN. Includes connector for PPD use. Includes concealed fixing covers. ! Excludes fixing base that needs to be purchased separately.



Prices - Gross prices		€
Description	Reference	
WRM Proximity Picopass for online and offline control units	W R M 7 0 0 1	315,55

Model WRM7000E

SALTO Modular Wall Reader for exterior use. Equipped with a special overhanging cap. To be used with CU50EN and/or CU50ENSVN. Includes concealed fixing covers.

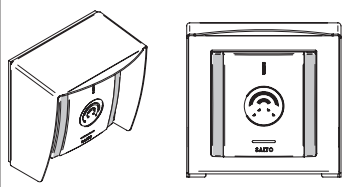

Prices - Gross prices		€
Description	Reference	
WRM Proximity Picopass with overhanging cap for online control units	W R M 7 0 0 0 E	467,95

Model WRM7001E

SALTO Modular Wall Reader for exterior use. Equipped with a special overhanging cap. To be used with CU5000, CU50EN and/or CU50ENSVN. Includes connector for PPD use. Includes concealed fixing covers.

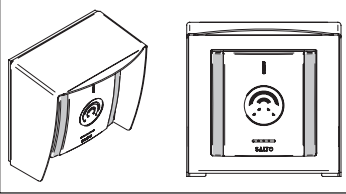

Prices - Gross prices		€
Description	Reference	
WRM Proximity Picopass for online and offline control units	W R M 7 0 0 1 E	467,95

Model WRM7000EK

SALTO Modular Wall Reader with key pad for exterior use. Equipped with a special overhanging cap. To be used with CU50EN and/or CU50ENSVN.

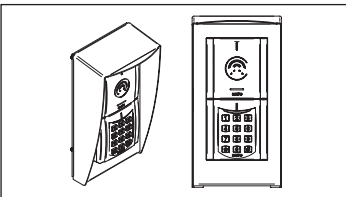

Prices - Gross prices		€
Description	Reference	
WRM Proximity Picopass with keypad and overhanging cap for online CU	W R M 7 0 0 0 E K	615,35

Model WRM7001EK

SALTO Modular Wall Reader with key pad for exterior use. Equipped with a special overhanging cap. To be used with CU5000, CU50EN and/or CU50ENSVN. Includes connector for PPD use.

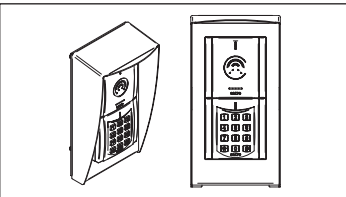

Prices - Gross prices		€
Description	Reference	
WRM Proximity Picopass with keypad & overhanging cap for online & offline CU	W R M 7 0 0 1 E K	615,35

Model WR7001FS

SALTO Wall Reader for narrow profile doors. To be used with CU5000, CU50EN and/or CU50ENSVN. Includes connector for PPD use.

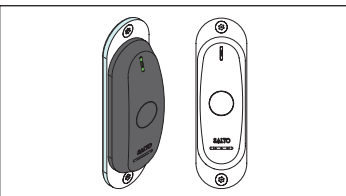

Prices - Gross prices		€
Description	Reference	
WR Proximity Picopass for narrow profile doors	W R 7 0 0 1 F S	315,55

Model WRM8000

SALTO Modular Wall Reader Proximity LEGIC.

LEGIC advant and prime compatible. To be used with CU50EN and/or CU50ENSVN. Includes concealed fixing covers. ! Excludes fixing base that needs to be purchased separately.

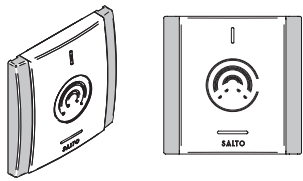

Prices - Gross prices		€
Description	Reference	
WRM Proximity LEGIC for online control units	W R M 8 0 0 0	300,60

Model WRM8001

SALTO Modular Wall Reader Proximity LEGIC.

LEGIC advant and prime compatible. To be used with CU5000, CU50EN and/or CU50ENSVN. Includes connector for PPD use. Includes. concealed fixing covers. ! Excludes fixing base that needs to be purchased separately.



Prices - Gross prices		€
Description	Reference	
WRM Proximity LEGIC for online and offline control units	W R M 8 0 0 1	300,60

Model WRM8000E

SALTO Modular Wall Reader Proximity for exterior use. Equipped with a special overhanging cap. LEGIC advant and prime compatible.

To be used with CU50EN and/or CU50ENSVN. Includes concealed fixing covers.
315,55

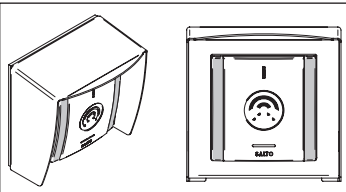

Prices - Gross prices		€
Description	Reference	
WRM Proximity LEGIC with overhanging cap for online control units	W R M 8 0 0 0 E	445,60

Model WRM8001E

SALTO Modular Wall Reader Proximity for exterior use. Equipped with a special overhanging cap. LEGIC advant and prime compatible. To be used with CU5000, CU50EN and/or CU50ENSVN. Includes connector for PPD use. Includes concealed fixing covers.

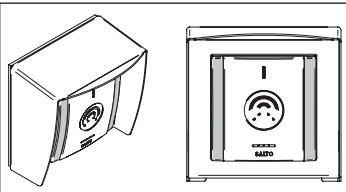

Prices - Gross prices		€
Description	Reference	
WRM Proximity LEGIC for online and offline control units	W R M 8 0 0 1 E	445,60

Model WRM8000EK

SALTO Modular Wall Reader Proximity LEGIC with key pad for exterior use. Equipped with a special overhanging cap.

LEGIC advant and prime compatible. To be used with CU50EN and/or CU50ENSVN.

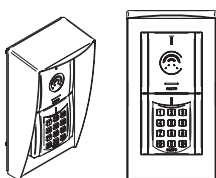

Prices - Gross prices		€
Description	Reference	
WRM Proximity LEGIC with keypad and overhanging cap for online CU	W R M 8 0 0 0 E K	792,05

Model WRM8001EK

SALTO Modular Wall Reader Proximity LEGIC with key pad for exterior use. Equipped with a special overhanging cap. LEGIC advant and prime compatible. To be used with CU5000, CU50EN and/or CU50ENSVN. Includes connector for PPD use.

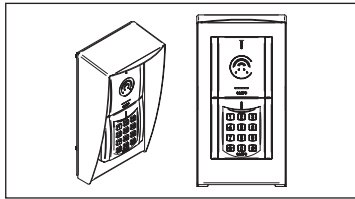

Prices - Gross prices		€
Description	Reference	
WRM Proximity LEGIC with keypad & overhanging cap for online & offline CU	W R M 8 0 0 1 E K	792,05

Model WR8001FS

SALTO Wall Reader Proximity LEGIC for narrow profile doors. LEGIC advant and prime compatible. To be used with CU5000, CU50EN and/or CU50ENSVN. Includes connector for PPD use.

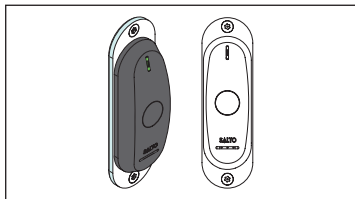

Prices - Gross prices		€
Description	Reference	
WR Proximity LEGIC for narrow profile doors	W R 8 0 0 1 F S	300,60

Model WRM9000

SALTO Modular Wall Reader Proximity DESFire/Mifare.
To be used with CU50EN and/or CU50ENSVN. Includes concealed fixing covers.
! Excludes fixing base that needs to be purchased separately.



Prices - Gross prices		€
Description	Reference	
WRM Proximity DESFire / Mifare for online control units	W R M 9 0 0 0	300,60

Model WRM9001

SALTO Modular Wall Reader Proximity DESFire/Mifare.
To be used with CU5000, CU50EN and/or CU50ENSVN. Includes connector for PPD use. Includes concealed fixing covers. ! Excludes fixing base that needs to be purchased separately.

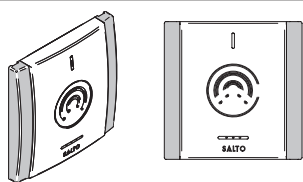

Prices - Gross prices		€
Description	Reference	
WRM Proximity DESFire / Mifare for online and offline control units	W R M 9 0 0 1	300,60

Model WRM9000E

SALTO Modular Wall Reader Proximity for exterior use. Equipped with a special overhanging cap. To be used with CU50EN and/or CU50ENSVN. Includes concealed fixing covers.

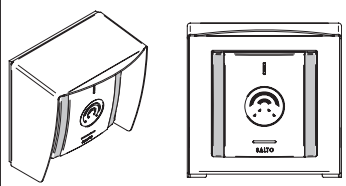

Prices - Gross prices		€
Description	Reference	
WRM Proximity DESFire / Mifare with overhanging cap for online control units	W R M 9 0 0 0 E	445,60

Model WRM9001E

SALTO Modular Wall Reader Proximity for exterior use. Equipped with a special overhanging cap. To be used with CU5000, CU50EN and/or CU50ENSVN. Includes connector for PPD use. Includes concealed fixing covers.

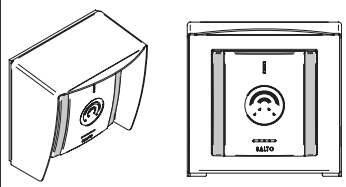

Prices - Gross prices		€
Description	Reference	
WRM Proximity DESFire / Mifare for online and offline control units	W R M 9 0 0 1 E	445,60

Model WRM9000EK

SALTO Modular Wall Reader Proximity DESFire/Mifare with key pad for exterior use. Equipped with a special overhanging cap.
To be used with CU50EN and/or CU50ENSVN.

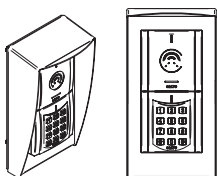

Prices - Gross prices		€
Description	Reference	
WRM Proximity DESFire / Mifare with keypad and overhanging cap for online CU	W R M 9 0 0 0 E K	792,05

Model WRM9001EK

SALTO Modular Wall Reader Proximity DESFire/Mifare with key pad for exterior use. Equipped with a special overhanging cap.
To be used with CU5000, CU50EN and/or CU50ENSVN. Includes connector for PPD use.

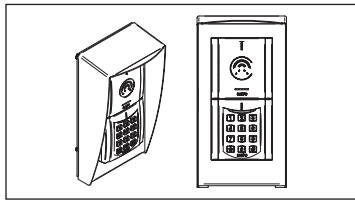

Prices - Gross prices		€
Description	Reference	
WRM Proximity DESFire/Mifare with keypad & overhanging cap for online & offline CU	W R M 9 0 0 1 E K	792,05

Model WR9001FS

SALTO Wall Reader Proximity DESFire/Mifare for narrow profile doors. To be used with CU5000, CU50EN and/or CU50ENSVN. Includes connector for PPD use.

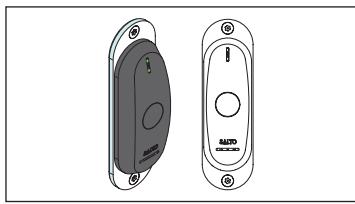

Prices - Gross prices		€
Description	Reference	
WR Proximity DESFire / Mifare for narrow profile doors	W R 9 0 0 1 F S	300,60

Model WRMH000

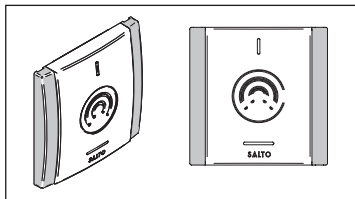

SALTO Modular Wall Reader.
To be used with CU50EN and/or CU50ENSVN. Includes concealed fixing covers.
! Excludes fixing base that needs to be purchased separately.

Prices - Gross prices		€
Description	Reference	
WRM Proximity HID i-CLASS for online control units	W R M H 0 0 0	346,40

Model WRMH001

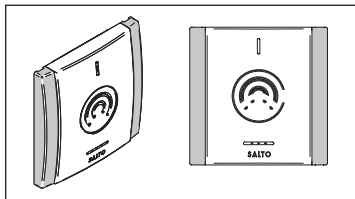

SALTO Modular Wall Reader.
To be used with CU5000, CU50EN and/or CU50ENSVN. Includes connector for PPD use. Includes concealed fixing covers. ! Excludes fixing base that needs to be purchased separately.

Prices - Gross prices		€
Description	Reference	
WRM Proximity HID i-CLASS for online and offline control units	W R M H 0 0 1	346,40

Model WRMH000E

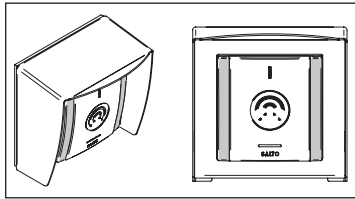

SALTO Modular Wall Reader Proximity for exterior use. Equipped with a special overhanging cap. To be used with CU50EN and/or CU50ENSVN. Includes concealed fixing covers.

Prices - Gross prices		€
Description	Reference	
WRM Proximity HID i-CLASS with overhanging cap for online control units	W R M H 0 0 0 E	527,30

Model WRMH001E

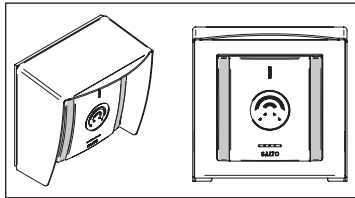

SALTO Modular Wall Reader Proximity for exterior use. Equipped with a special overhanging cap. To be used with CU5000, CU50EN and/or CU50ENSVN. Includes connector for PPD use. Includes concealed fixing covers.

Prices - Gross prices		€
Description	Reference	
WRM HID i-CLASS for online and offline control units	W R M H 0 0 1 E	527,30

Model WRMH000EK

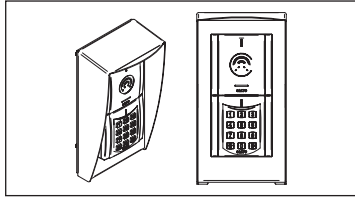

SALTO Modular Wall Reader Proximity with key pad for exterior use. Equipped with a special overhanging cap.
To be used with CU50EN and/or CU50ENSVN.

Prices - Gross prices		€
Description	Reference	
WRM Proximity HID i-CLASS with keypad and overhanging cap for online CU	W R M H 0 0 0 E K	884,75

Model
WRMH001EK

SALTO Modular Wall Reader Proximity with key pad for exterior use. Equipped with a special overhanging cap.
To be used with CU5000, CU50EN and/or CU50ENSVN. Includes connector for PPD use.

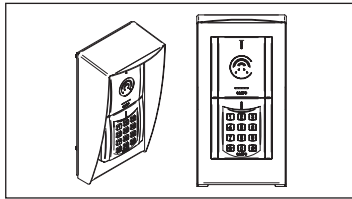

Prices - Gross prices		€
Description	Reference	
WRM Proximity HID i-CLASS with keypad & overhanging cap for online & offline CU	W R M H 0 0 1 E K	884,50

Model
WRH001FS

SALTO Wall Reader Proximity DESFire/Mifare for narrow profile doors. To be used with CU5000, CU50EN and/or CU50ENSVN. Includes connector for PPD use.

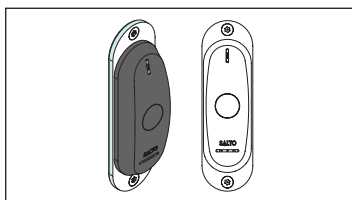

Prices - Gross prices		€
Description	Reference	
WR Proximity DESFire / Mifare for narrow profile doors	W R H 0 0 1 F S	346,40

Wall readers accessories

Model
WRMKP

SALTO Key Pad for Modular Wall Readers.
Wall Reader Key pad for dual identification. To be mounted with a WRMBL2 or a WRMBH2 base.

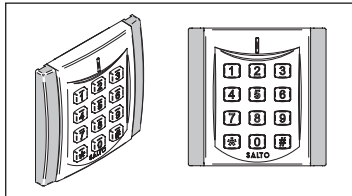

Prices - Gross prices		€
Description	Reference	
Key pad for modular wall readers	W R M K P	351,95

Model
WRMBL1

SALTO Single reader base for flush mounting for Modular Wall Readers.

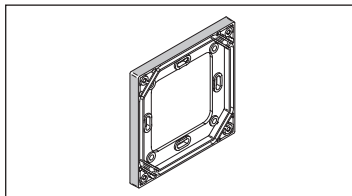

Prices - Gross prices		€
Description	Reference	
Single reader base for flush mounting	W R M B L 1	14,35

Model
WRMBL2

SALTO Double Reader Base for flush mounting for modular wall readers.

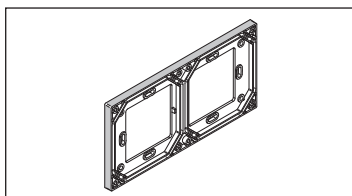

Prices - Gross prices		€
Description	Reference	
Double reader base for flush mounting for modular wall readers	W R M B L 2	17,75

Model WRMBH1

SALTO Single Reader Base for surface mounting for modular wall readers.

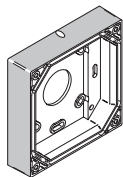

Prices - Gross prices		€
Description	Reference	
Single reader base for surface mounting for modular wall readers	W R M B H 1	15,95

Model WRMBH2

SALTO Double Reader Base for surface mounting for modular wall readers.

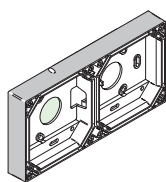

Prices - Gross prices		€
Description	Reference	
Double reader base for surface mounting for modular wall readers	W R M B H 2	19,15

Model WRMFWAV

SALTO Wall Reader Anti Vandalic Frame (for fitting with WRMBLE) for Modular Wall Readers. Base for flush mounting WRMBLE included with the WRMFWAV.

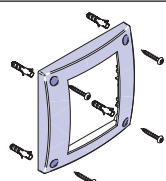

Prices - Gross prices		€
Description	Reference	
Wall reader anti vandalic frame for modular wall readers (flush mounting)	W R M F W A V	49,70

Model WRMFHAV

SALTO Wall Reader Anti Vandalic Frame (for fitting with WRMBH1) for Modular Wall Readers. Base for surface mounting WRMBH1 included with the WRMFHAV.

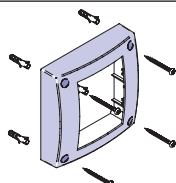

Prices - Gross prices		€
Description	Reference	
Wall reader anti vandalic frame for modular wall readers (surface mounting)	W R M F H A V	52,80

Model WRMFS

SALTO Spare concealed fixing covers for Modular Wall Readers.

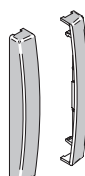

Prices - Gross prices		€
Description	Reference	
Spare concealed fixing covers (per pair).	W R M F S	3,90

Model WRMPE7SN

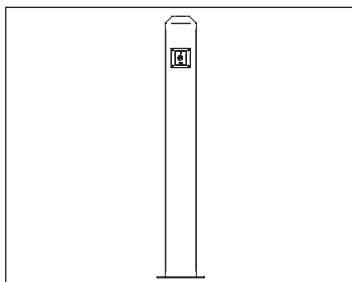

Fixing screws included (3M8x60 DIN 7991 A2 screws and 3 Fischer TA M8 Anchors).

SALTO can deliver the set mounted if ordered.

If you order WRMPENSN00, the pedestal will be delivered without wall reader and keypad, it will just have the fitting holes.

SALTO Pedestal for one WRM and one control unit.

Made of stainless steel AISI 316L bright polished.

The WRMFWAV and the base WRMBLE included if the wall reader has been ordered.

Prices - Gross prices						€
Model	Wall Reader technology	Reference pedestal	Key Pad option	Control Unit option	Control unit power supply	
WRMPE	N No wall reader	S Single wall reader	N No key pad	00 No control unit	-	1222,55
WRMPE	7 WRM7001	S Single wall reader	N No key pad	50 CU5000	EU	2059,50
					UK	
					US	
					AUS	
WRMPE	7 WRM7001	S Single wall reader	N No key pad	5E CU50EN	EU	2284,10
					UK	
					US	
					AUS	
WRMPE	7 WRM7001	S Single wall reader	N No key pad	5S CU50ENSVN	EU	2374,05
					UK	
					US	
					AUS	

Model WRMPE7SK

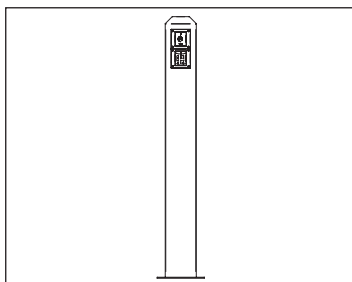

Fixing screws included (3M8x60 DIN 7991 A2 screws and 3 Fischer TA M8 Anchors).

SALTO can deliver the set mounted if ordered.

If you order WRMPENSK00, the pedestal will be delivered without wall readers and keypad, it will just have the fitting holes.

SALTO WRM pedestal for one wall reader and one key pad.

Made of stainless steel AISI 316L bright polished.

The WRMFWAV and the base WRMBLE included if the wall reader has been ordered.

Prices - Gross prices						€
Model	Wall Reader technology	Reference pedestal	Key Pad option	Control Unit option	Control unit power supply	
WRMPE	N No wall reader	S Single wall reader	K Key pad	00 No control unit	-	1258,50
WRMPE	7 WRM7001	S Single wall reader	K Key pad	50 CU5000	EU	2095,45
					UK	
					US	
					AUS	
WRMPE	7 WRM7001	S Single wall reader	K Key pad	5E CU50EN	EU	2320,10
					UK	
					US	
					AUS	
WRMPE	7 WRM7001	S Single wall reader	K Key pad	5S CU50ENSVN	EU	2410,10
					UK	
					US	
					AUS	

Model WRMPE7DN

SALTO Wall reader modular pedestal 2 wall readers (DDA compliant).

Made of stainless steel AISI 316L bright polished.

The WRMFWAV and the base WRMBLE included if the wall reader has been ordered.

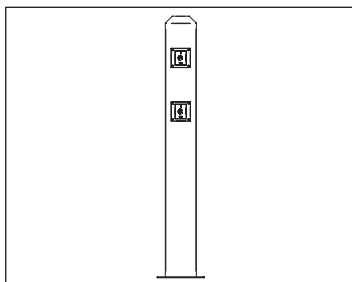

Fixing screws included (3M8x60 DIN 7991 A2 screws and 3 Fischer TA M8 Anchors).

SALTO can deliver the set mounted if ordered.

If you order WRMPENDN00, the pedestal will be delivered without wall readers and keypad, it will just have the fitting holes.

Prices - Gross prices						€
Model	Wall Reader technology	Reference pedestal	Key Pad option	Control Unit option	Control unit power supply	
WRMPE	N No wall reader	D 2 wall readers (DDA Compliant)	N No key pad	00 No control unit	-	1258,50
WRMPE	7 WRM7001	D 2 wall readers (DDA Compliant)	N No key pad	50 CU5000	EU	2411,10
					UK	
					US	
					AUS	
WRMPE	7 WRM7001	D 2 wall readers (DDA Compliant)	N No key pad	5E CU50EN	EU	2635,80
					UK	
					US	
					AUS	
WRMPE	7 WRM7001	D 2 wall readers (DDA Compliant)	N No key pad	5S CU50ENSVN	EU	2725,60
					UK	
					US	
					AUS	

Model WRMPE7DK

SALTO Pedestal for two WRM, key pad (DDA compliant) and one control unit.

Made of stainless steel AISI 316L bright polished.

The WRMFWAV and the base WRMBLE included if the wall reader has been ordered.

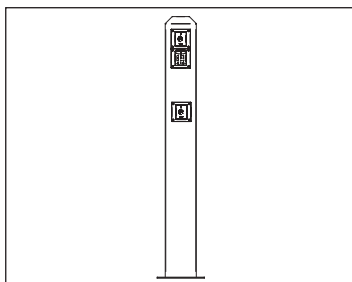

Fixing screws included (3M8x60 DIN 7991 A2 screws and 3 Fischer TA M8 Anchors).

SALTO can deliver the set mounted if ordered.

If you order WRMPENDK00, the pedestal will be delivered without wall reader and keypad, it will just have the fitting holes.

Prices - Gross prices						€
Model	Wall Reader technology	Reference pedestal	Key Pad option	Control Unit option	Control unit power supply	
WRMPE	N No wall reader	D 2 wall readers (DDA Compliant)	K Key pad	00 No control unit	-	1272,90
WRMPE	7 WRM7001	D 2 wall readers (DDA Compliant)	K Key pad	50 CU5000	EU	2425,50
					UK	
					US	
					AUS	
WRMPE	7 WRM7001	D 2 wall readers (DDA Compliant)	K Key pad	5E CU50EN	EU	2650,15
					UK	
					US	
					AUS	
WRMPE	7 WRM7001	D 2 wall readers (DDA Compliant)	K Key pad	5S CU50ENSVN	EU	2740,10
					UK	
					US	
					AUS	

Model WRMPE8SN

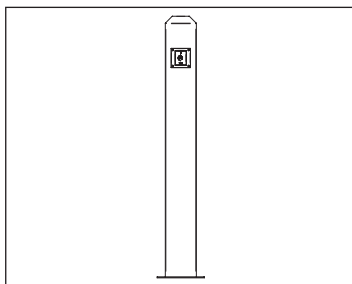

Fixing screws included (3M8x60 DIN 7991 A2 screws and 3 Fischer TA M8 Anchors).

SALTO can deliver the set mounted if ordered.

If you order WRMPENS00, the pedestal will be delivered without wall reader and keypad, it will just have the fitting holes.

SALTO Pedestal for one WRM and one control unit.

Made of stainless steel AISI 316L bright polished.

The WRMFWAV and the base WRMBLE included if the wall reader has been ordered.

Prices - Gross prices						€
Model	Wall Reader technology	Reference pedestal	Key Pad option	Control Unit option	Control unit power supply	
WRMPE	N No wall reader	S Single wall reader	N No key pad	00 No control unit	-	1222,55
WRMPE	8 WRM8001	S Single wall reader	N No key pad	50 CU5000	EU	2044,45
					UK	
					US	
					AUS	
WRMPE	8 WRM8001	S Single wall reader	N No key pad	5E CU50EN	EU	2269,10
					UK	
					US	
					AUS	
WRMPE	8 WRM8001	S Single wall reader	N No key pad	5S CU50ENSVN	EU	2359,10
					UK	
					US	
					AUS	

Model WRMPE8SK

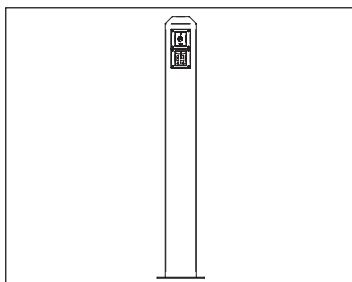

Fixing screws included (3M8x60 DIN 7991 A2 screws and 3 Fischer TA M8 Anchors).

SALTO can deliver the set mounted if ordered.

If you order WRMPENSK00, the pedestal will be delivered without wall readers and keypad, it will just have the fitting holes.

SALTO WRM pedestal for one wall reader and one key pad.

Made of stainless steel AISI 316L bright polished.

The WRMFWAV and the base WRMBLE included if the wall reader has been ordered.

Prices - Gross prices						€
Model	Wall Reader technology	Reference pedestal	Key Pad option	Control Unit option	Control unit power supply	
WRMPE	N No wall reader	S Single wall reader	K Key pad	00 No control unit	-	1258,50
WRMPE	8 WRM8001	S Single wall reader	K Key pad	50 CU5000	EU	2080,40
					UK	
					US	
					AUS	
WRMPE	8 WRM8001	S Single wall reader	K Key pad	5E CU50EN	EU	2335,00
					UK	
					US	
					AUS	
WRMPE	8 WRM8001	S Single wall reader	K Key pad	5S CU50ENSVN	EU	2395,05
					UK	
					US	
					AUS	

Model WRMPE8DN

SALTO Wall reader modular pedestal 2 wall readers (DDA compliant).

Made of stainless steel AISI 316L bright polished.

The WRMFWAV and the base WRMBLE included if the wall reader has been ordered.

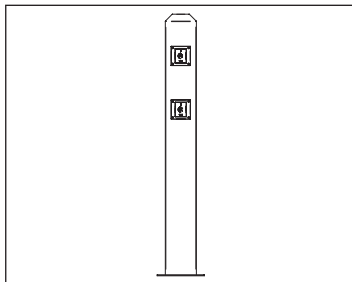

Fixing screws included (3M8x60 DIN 7991 A2 screws and 3 Fischer TA M8 Anchors).

SALTO can deliver the set mounted if ordered.

If you order WRMPENDN00, the pedestal will be delivered without wall readers and keypad, it will just have the fitting holes.

Prices - Gross prices						€
Model	Wall Reader technology	Reference pedestal	Key Pad option	Control Unit option	Control unit power supply	
WRMPE	N No wall reader	D 2 wall readers (DDA Compliant)	N No key pad	00 No control unit	-	1258,50
WRMPE	8 WRM8001	D 2 wall readers (DDA Compliant)	N No key pad	50 CU5000	EU	2381,00
					UK	
					US	
					AUS	
WRMPE	8 WRM8001	D 2 wall readers (DDA Compliant)	N No key pad	5E CU50EN	EU	2605,65
					UK	
					US	
					AUS	
WRMPE	8 WRM8001	D 2 wall readers (DDA Compliant)	N No key pad	5S CU50ENSVN	EU	2695,70
					UK	
					US	
					AUS	

Model WRMPE8DK

SALTO Pedestal for two WRM, key pad (DDA compliant) and one control unit.

Made of stainless steel AISI 316L bright polished.

The WRMFWAV and the base WRMBLE included if the wall reader has been ordered.

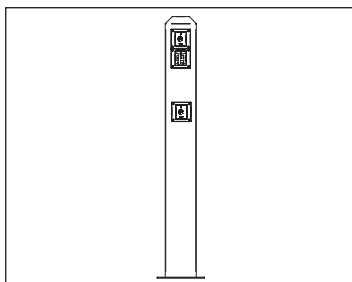

Fixing screws included (3M8x60 DIN 7991 A2 screws and 3 Fischer TA M8 Anchors).

SALTO can deliver the set mounted if ordered.

If you order WRMPENDK00, the pedestal will be delivered without wall reader and keypad, it will just have the fitting holes.

Prices - Gross prices						€
Model	Wall Reader technology	Reference pedestal	Key Pad option	Control Unit option	Control unit power supply	
WRMPE	N No wall reader	D 2 wall readers (DDA Compliant)	K Key pad	00 No control unit	-	1272,90
WRMPE	8 WRM8001	D 2 wall readers (DDA Compliant)	K Key pad	50 CU5000	EU	2395,45
					UK	
					US	
					AUS	
WRMPE	8 WRM8001	D 2 wall readers (DDA Compliant)	K Key pad	5E CU50EN	EU	2620,10
					UK	
					US	
					AUS	
WRMPE	8 WRM8001	D 2 wall readers (DDA Compliant)	K Key pad	5S CU50ENSVN	EU	2710,20
					UK	
					US	
					AUS	

Model WRMPE9SN

SALTO Pedestal for one WRM and one control unit.

Made of stainless steel AISI 316L bright polished.

The WRMFWAV and the base WRMBLE included if the wall reader has been ordered.

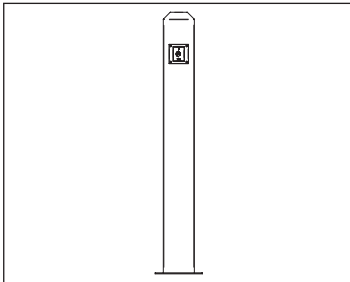

Fixing screws included (3M8x60 DIN 7991 A2 screws and 3 Fischer TA M8 Anchors).

SALTO can deliver the set mounted if ordered.

If you order WRMPENSN00, the pedestal will be delivered without wall reader and keypad, it will just have the fitting holes.

Prices - Gross prices						€
Model	Wall Reader technology	Reference pedestal	Key Pad option	Control Unit option	Control unit power supply	
WRMPE	N No wall reader	S Single wall reader	N No key pad	00 No control unit	-	1222,55
WRMPE	9 WRM9001	S Single wall reader	N No key pad	50 CU5000	EU	2044,45
					UK	
					US	
					AUS	
WRMPE	9 WRM9001	S Single wall reader	N No key pad	5E CU50EN	EU	2269,10
					UK	
					US	
					AUS	
WRMPE	9 WRM9001	S Single wall reader	N No key pad	5S CU50ENSVN	EU	2359,10
					UK	
					US	
					AUS	

Model WRMPE9SK

SALTO WRM pedestal for one wall reader and one key pad.

Made of stainless steel AISI 316L bright polished.

The WRMFWAV and the base WRMBLE included if the wall reader has been ordered.

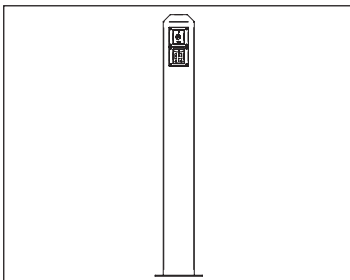

Fixing screws included (3M8x60 DIN 7991 A2 screws and 3 Fischer TA M8 Anchors).

SALTO can deliver the set mounted if ordered.

If you order WRMPENSK00, the pedestal will be delivered without wall readers and keypad, it will just have the fitting holes.

Prices - Gross prices						€
Model	Wall Reader technology	Reference pedestal	Key Pad option	Control Unit option	Control unit power supply	
WRMPE	N No wall reader	S Single wall reader	K Key pad	00 No control unit	-	1258,50
WRMPE	9 WRM9001	S Single wall reader	K Key pad	50 CU5000	EU	2080,40
					UK	
					US	
					AUS	
WRMPE	9 WRM9001	S Single wall reader	K Key pad	5E CU50EN	EU	2335,00
					UK	
					US	
					AUS	
WRMPE	9 WRM9001	S Single wall reader	K Key pad	5S CU50ENSVN	EU	2395,05
					UK	
					US	
					AUS	

Model WRMPE9DN

SALTO Wall reader modular pedestal 2 wall readers (DDA compliant).

Made of stainless steel AISI 316L bright polished.

The WRMFWAV and the base WRMBLE included if the wall reader has been ordered.

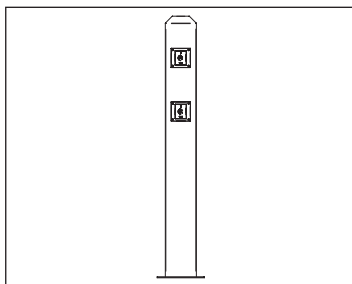

Fixing screws included (3M8x60 DIN 7991 A2 screws and 3 Fischer TA M8 Anchors).

SALTO can deliver the set mounted if ordered.

If you order WRMPENDN00, the pedestal will be delivered without wall readers and keypad, it will just have the fitting holes.

Prices - Gross prices						€
Model	Wall Reader technology	Reference pedestal	Key Pad option	Control Unit option	Control unit power supply	
WRMPE	N No wall reader	D 2 wall readers (DDA Compliant)	N No key pad	00 No control unit	-	1258,50
WRMPE	9 WRM9001	D 2 wall readers (DDA Compliant)	N No key pad	50 CU5000	EU	2381,00
					UK	
					US	
					AUS	
WRMPE	9 WRM9001	D 2 wall readers (DDA Compliant)	N No key pad	5E CU50EN	EU	2605,65
					UK	
					US	
					AUS	
WRMPE	9 WRM9001	D 2 wall readers (DDA Compliant)	N No key pad	5S CU50ENSVN	EU	2695,70
					UK	
					US	
					AUS	

Model WRMPE9DK

SALTO Pedestal for two WRM, key pad (DDA compliant) and one control unit.

Made of stainless steel AISI 316L bright polished.

The WRMFWAV and the base WRMBLE included if the wall reader has been ordered.

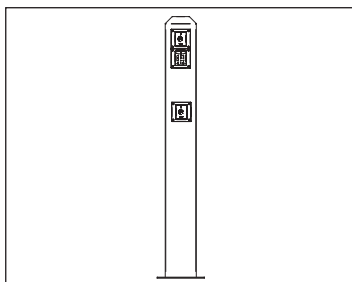

Fixing screws included (3M8x60 DIN 7991 A2 screws and 3 Fischer TA M8 Anchors).

SALTO can deliver the set mounted if ordered.

If you order WRMPENDK00, the pedestal will be delivered without wall reader and keypad, it will just have the fitting holes.

Prices - Gross prices						€
Model	Wall Reader technology	Reference pedestal	Key Pad option	Control Unit option	Control unit power supply	
WRMPE	N No wall reader	D 2 wall readers (DDA Compliant)	K Key pad	00 No control unit	-	1272,90
WRMPE	9 WRM9001	D 2 wall readers (DDA Compliant)	K Key pad	50 CU5000	EU	2395,45
					UK	
					US	
					AUS	
WRMPE	9 WRM9001	D 2 wall readers (DDA Compliant)	K Key pad	5E CU50EN	EU	2620,10
					UK	
					US	
					AUS	
WRMPE	9 WRM9001	D 2 wall readers (DDA Compliant)	K Key pad	5S CU50ENSVN	EU	2710,20
					UK	
					US	
					AUS	

Model WRMPEHSN

SALTO Pedestal for one WRM and one control unit.
 Made of stainless steel AISI 316L bright polished.
 The WRMFWAV and the base WRMBLE included if the wall reader has been ordered.

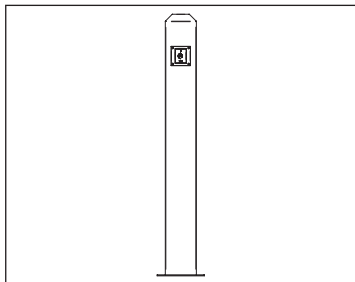

Fixing screws included (3M8x60 DIN 7991 A2 screws and 3 Fischer TA M8 Anchors).

SALTO can deliver the set mounted if ordered.

If you order WRMPENS00, the pedestal will be delivered without wall reader and keypad, it will just have the fitting holes.

Prices - Gross prices						€
Model	Wall Reader technology	Reference pedestal	Key Pad option	Control Unit option	Control unit power supply	
WRMPE	N No wall reader	S Single wall reader	N No key pad	00 No control unit	-	1222,55
WRMPE	H WRMH001	S Single wall reader	N No key pad	50 CU5000	EU	2074,35
					UK	
					US	
					AUS	
WRMPE	H WRMH001	S Single wall reader	N No key pad	5E CU50EN	EU	2299,00
					UK	
					US	
					AUS	
WRMPE	H WRMH001	S Single wall reader	N No key pad	5S CU50ENSVN	EU	2388,85
					UK	
					US	
					AUS	

Model WRMPEHSK

SALTO WRM pedestal for one wall reader and one key pad.
 Made of stainless steel AISI 316L bright polished.
 The WRMFWAV and the base WRMBLE included if the wall reader has been ordered.

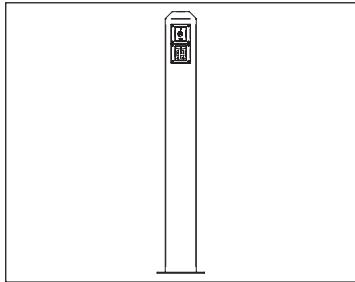

Fixing screws included (3M8x60 DIN 7991 A2 screws and 3 Fischer TA M8 Anchors).

SALTO can deliver the set mounted if ordered.

If you order WRMPENSK00, the pedestal will be delivered without wall readers and keypad, it will just have the fitting holes.

Prices - Gross prices						€
Model	Wall Reader technology	Reference pedestal	Key Pad option	Control Unit option	Control unit power supply	
WRMPE	N No wall reader	S Single wall reader	K Key pad	00 No control unit	-	1258,50
WRMPE	H WRMH001	S Single wall reader	K Key pad	50 CU5000	EU	2110,40
					UK	
					US	
					AUS	
WRMPE	H WRMH001	S Single wall reader	K Key pad	5E CU50EN	EU	2335,00
					UK	
					US	
					AUS	
WRMPE	H WRMH001	S Single wall reader	K Key pad	5S CU50ENSVN	EU	2424,95
					UK	
					US	
					AUS	

Model WRMPEHDN

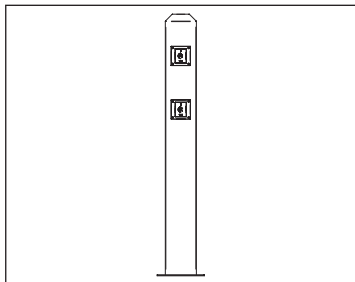

Fixing screws included (3M8x60 DIN 7991 A2 screws and 3 Fischer TA M8 Anchors).

SALTO can deliver the set mounted if ordered.

If you order WRMPEHDN00, the pedestal will be delivered without wall readers and keypad, it will just have the fitting holes.

SALTO Wall reader modular pedestal 2 wall readers (DDA compliant).

Made of stainless steel AISI 316L bright polished.

The WRMFWAV and the base WRMBLE included if the wall reader has been ordered.

Prices - Gross prices						€
Model	Wall Reader technology	Reference pedestal	Key Pad option	Control Unit option	Control unit power supply	
WRMPE	N No wall reader	D 2 wall readers (DDA Compliant)	N No key pad	00 No control unit	-	1258,50
WRMPE	H WRMH001	D 2 wall readers (DDA Compliant)	N No key pad	50 CU5000	EU	2440,85
					UK	
					US	
					AUS	
WRMPE	H WRMH001	D 2 wall readers (DDA Compliant)	N No key pad	5E CU50EN	EU	2665,50
					UK	
					US	
					AUS	
WRMPE	H WRMH001	D 2 wall readers (DDA Compliant)	N No key pad	5S CU50ENSVN	EU	2755,45
					UK	
					US	
					AUS	

Model WRMPEHDK

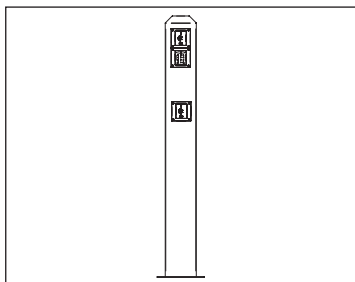

Fixing screws included (3M8x60 DIN 7991 A2 screws and 3 Fischer TA M8 Anchors).

SALTO can deliver the set mounted if ordered.

If you order WRMPEHDK00, the pedestal will be delivered without wall reader and keypad, it will just have the fitting holes.

SALTO Pedestal for two WRM, key pad (DDA compliant) and one control unit.

Made of stainless steel AISI 316L bright polished.

The WRMFWAV and the base WRMBLE included if the wall reader has been ordered.

Prices - Gross prices						€
Model	Wall Reader technology	Reference pedestal	Key Pad option	Control Unit option	Control unit power supply	
WRMPE	N No wall reader	D 2 wall readers (DDA Compliant)	K Key pad	00 No control unit	-	1272,90
WRMPE	H WRMH001	D 2 wall readers (DDA Compliant)	K Key pad	50 CU5000	EU	2455,25
					UK	
					US	
					AUS	
WRMPE	H WRMH001	D 2 wall readers (DDA Compliant)	K Key pad	5E CU50EN	EU	2679,80
					UK	
					US	
					AUS	
WRMPE	H WRMH001	D 2 wall readers (DDA Compliant)	K Key pad	5S CU50ENSVN	EU	2769,90
					UK	
					US	
					AUS	

WRMPExSNxx
One Wall Reader

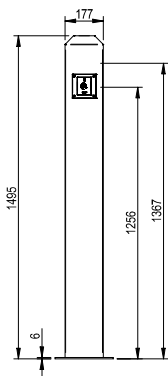

WRMPExSKxx
One Wall Reader and Key pad

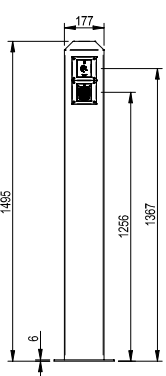

WRMPExDNxx
Two Wall Readers
DDA compliant

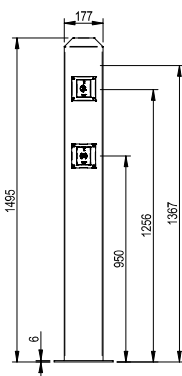

WRMPExDKxx
Two Wall Readers and one
Key pad.
DDA compliant

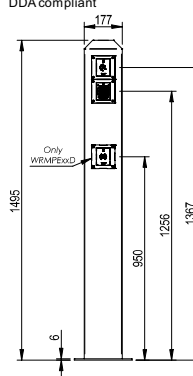



Model WRDB0x4x

SALTO reader Proximity BLE DESFire/Mifare.
For European standard. Squared or conical shape.
To be used with CU42xxx range

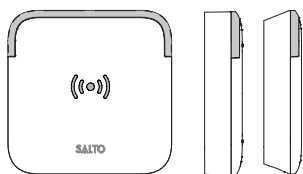

Prices - Gross prices

Description	Reference
WRD DESFire / Mifare - White colour - Conical base	W R D B 0 E 4 W
WRD DESFire / Mifare - Black colour - Conical base	W R D B 0 E 4 B
WRD DESFire / Mifare - White colour - Squared base	W R D B 0 S 4 W
WRD DESFire / Mifare - Black colour - Squared base	W R D B 0 S 4 B

€

300,60

Model WRDB0x4xK

SALTO reader Proximity BLE DESFire/Mifare with keypad.
For European standard. Squared and conical shape.
To be used with CU42xxx range

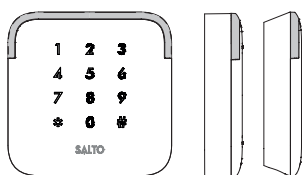

Prices - Gross prices

Description	Reference
WRD Proximity BLE DESFire / Mifare - White colour	W R D B 0 E 4 W K
WRD Proximity BLE DESFire / Mifare - Black colour	W R D B 0 E 4 B K
WRD DESFire / Mifare - White colour - Squared base	W R D B 0 S 4 W K
WRD DESFire / Mifare - Black colour - Squared base	W R D B 0 S 4 B K

€

460,40

Model WRDB0A4x

SALTO reader Proximity BLE DESFire/Mifare.
For ANSI standard. Rectangular.
To be used with CU42xxx range

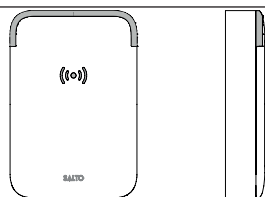

Prices - Gross prices

Description	Reference
WRD Proximity BLE DESFire / Mifare - White colour	W R D B 0 A 4 W
WRD Proximity BLE DESFire / Mifare - Black colour	W R D B 0 A 4 B

€

314,70

<p>Model WRDB0A4xK</p>	<p>SALTO reader Proximity BLE DESFire/Mifare with keypad. For ANSI standard. Rectangular. To be used with CU42xxx range</p>
--	---

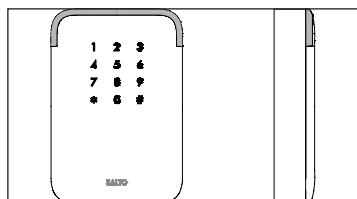

Prices - Gross prices		€
Description	Reference	462,30
WRD Proximity BLE DESFire / Mifare - White colour	W R D B 0 A 4 W K	
WRD Proximity BLE DESFire / Mifare - Black colour	W R D B 0 A 4 B K	

<p>Model WRMB004x</p>	<p>SALTO Modular Wall Reader Proximity BLE DESFire/Mifare. To be used with CU42xxx range. Includes concealed fixing covers. ! Excludes fixing base that needs to be purchased separately.</p>
---	---

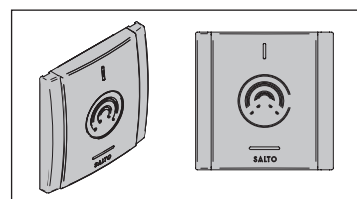

Prices - Gross prices		€
Description	Reference	300,60
SALTO Modular Wall Reader BLE MIFARE black finish	W R M B 0 0 4 B	
SALTO Modular Wall Reader BLE MIFARE white finish	W R M B 0 0 4 W	
SALTO Modular Wall Reader BLE MIFARE silver finish	W R M B 0 0 4 S	

<p>Model WRDB0M4x</p>	<p>SALTO XS4 Mullion Reader Proximity BLE DESFire/Mifare. Mullion reader to be fitted in narrow profile surfaces. To be used with CU42xxx range</p>
---	---

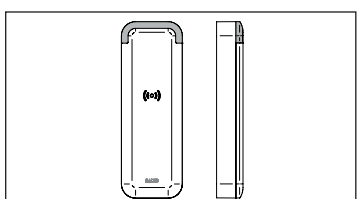

Prices - Gross prices		€
Description	Reference	300,60
Mullion reader BLE DESFire / Mifare - White colour	W R D B 0 M 4 W	
Mullion reader BLE DESFire / Mifare - Black colour	W R D B 0 M 4 B	

<p>Model WRDB0P40</p>	<p>SALTO XS4 Panel Reader Proximity BLE DESFire/Mifare. Includes white and silver stickers. To be used with CU42xxx range</p>
---	---

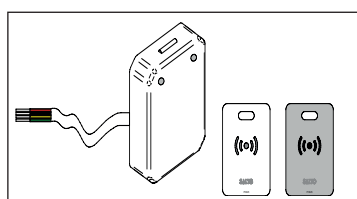

Prices - Gross prices		€
Description	Reference	300,60
Panel reader BLE DESFire / Mifare	W R D B 0 P 4 0	

Model WRDG0x4xK

SALTO reader Proximity BLE LEGIC ADVANT with keypad.
For European standard. Squared and conical shape.
To be used with CU42xxx range

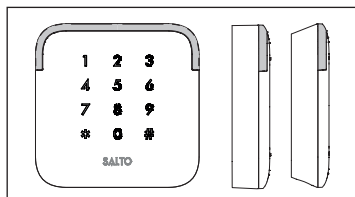

Prices - Gross prices		€
Description	Reference	
WRD BLE LEGIC ADVANT - White colour	W R D G 0 E 4 W K	344,65
WRD BLE LEGIC ADVANT - Black colour	W R D G 0 E 4 B K	
WRD BLE LEGIC ADVANT - White colour - Squared base	W R D G 0 S 4 W K	
WRD BLE LEGIC ADVANT - Black colour - Squared base	W R D G 0 S 4 B K	

Model WRDG0A4xK

SALTO reader Proximity BLE LEGIC ADVANT with keypad.
For ANSI standard. Rectangular.
To be used with CU42xxx range

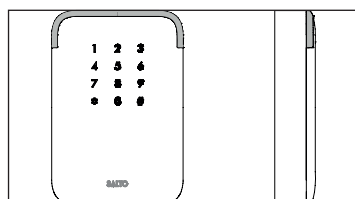

Prices - Gross prices		€
Description	Reference	
WRD BLE LEGIC ADVANT - White colour	W R D G 0 A 4 W K	346,10
WRD BLE LEGIC ADVANT - Black colour	W R D G 0 A 4 B K	

Model WRDJ0x4

SALTO reader Proximity BLE HID iCLASS.
For European standard. Squared or conical shape.
To be used with CU42xxx range

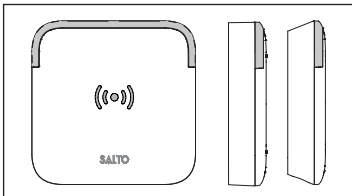

Prices - Gross prices		€
Description	Reference	
WRD BLE HID iCLASS - White colour - Conical base	W R D J 0 E 4 W	346,40
WRD BLE HID iCLASS - Black colour - Conical base	W R D J 0 E 4 B	
WRD BLE HID iCLASS - White colour - Squared base	W R D J 0 S 4 W	
WRD BLE HID iCLASS - Black colour - Squared base	W R D J 0 S 4 B	

Model WRDJ0x4xK

SALTO reader Proximity BLE HID iCLASS with keypad.
For European standard. Squared and conical shape.
To be used with CU42xxx range

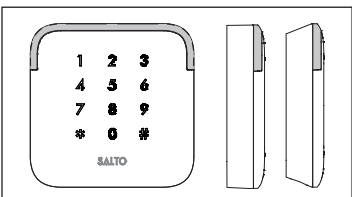

Prices - Gross prices		€
Description	Reference	
WRD Proximity BLE HID iCLASS - White colour	W R D J 0 E 4 W K	530,50
WRD Proximity BLE HID iCLASS - Black colour	W R D J 0 E 4 B K	
WRD BLE HID iCLASS - White colour - Squared base	W R D J 0 S 4 W K	
WRD BLE HID iCLASS - Black colour - Squared base	W R D J 0 S 4 B K	

Model WRDJ0Ax

SALTO reader Proximity BLE HID iCLASS.
For ANSI standard. Rectangular.
To be used with CU42xxx range

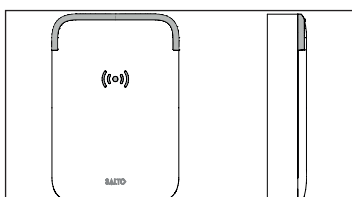

Prices - Gross prices		€
Description	Reference	
WRD Proximity BLE HID iCLASS - White colour	W R D J 0 A 4 W	362,65
WRD Proximity BLE HID iCLASS - Black colour	W R D J 0 A 4 B	

Model WRDJ0AxK

SALTO reader Proximity BLE HID iCLASS with keypad.
For ANSI standard. Rectangular.
To be used with CU42xxx range

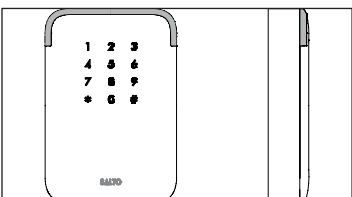

Prices - Gross prices		€
Description	Reference	
WRD Proximity BLE HID iCLASS - White colour	W R D J 0 A 4 W K	532,65
WRD Proximity BLE HID iCLASS - Black colour	W R D J 0 A 4 B K	

Model WRMJ004x

SALTO Modular Wall Reader Proximity BLE HID iCLASS.

To be used with CU42xxx range. Includes concealed fixing covers.
! Excludes fixing base that needs to be purchased separately.

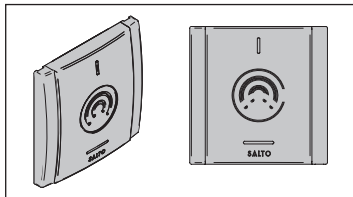

Prices - Gross prices		€
Description	Reference	
SALTO Modular Wall Reader BLE HID iCLASS black finish	W R M J 0 0 4 B	346,40
SALTO Modular Wall Reader BLE HID iCLASS white finish	W R M J 0 0 4 W	
SALTO Modular Wall Reader BLE HID iCLASS silver finish	W R M J 0 0 4 S	

Model WRDJ0M4x

SALTO XS4 Mullion Reader Proximity BLE HID iCLASS.

Mullion reader to be fitted in narrow profile surfaces.

To be used with CU42xxx range

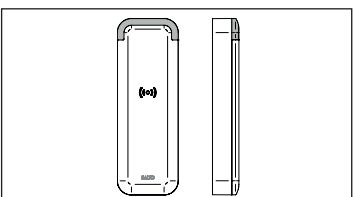

Prices - Gross prices		€
Description	Reference	
Mullion reader BLE HID iCLASS - White colour	W R D J 0 M 4 W	346,40
Mullion reader BLE HID iCLASS - Black colour	W R D J 0 M 4 B	

Model WRDJ0P40

SALTO XS4 Panel Reader Proximity BLE HID iCLASS.

Includes white and silver stickers.

To be used with CU42xxx range

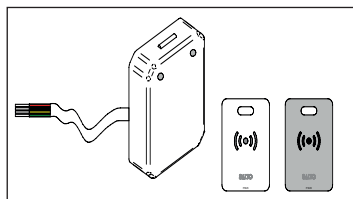

Prices - Gross prices		€
Description	Reference	
Panel reader BLE HID iCLASS	W R D J 0 P 4 0	346,40

Model WRMBL1x

SALTO Single reader base for flush mounting for Modular Wall Readers.

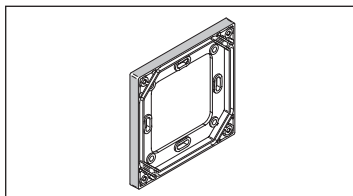

Prices - Gross prices		€
Description	Reference	
Single reader base for flush mounting black finish	W R M B L 1 B	14,35
Single reader base for flush mounting white finish	W R M B L 1 W	
Single reader base for flush mounting silver finish	W R M B L 1 S	

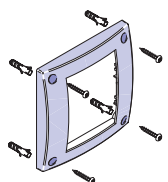
Model WRMFWAV	SALTO Wall Reader Anti Vandalic Frame (for fitting with WRMBLE) for Modular Wall Readers. Base for flush mounting WRMBLE included with the WRMFWAV.		
	Prices - Gross prices		€
	Description	Reference	
	Wall reader anti vandalic frame for modular wall readers (flush mounting)	W R M F W A V	49,70

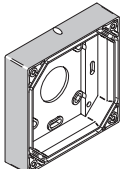
Model WRMBH1x	SALTO Single Reader Base for surface mounting for modular wall readers.		
	Prices - Gross prices		€
	Description	Reference	
	Single reader base for surface mounting black finish	W R M B H 1 B	15,95
	Single reader base for surface mounting white finish	W R M B H 1 W	
Single reader base for surface mounting silver finish	W R M B H 1 S		

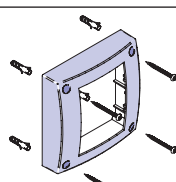
Model WRMFHAV	SALTO Wall Reader Anti Vandalic Frame (for fitting with WRMBH1) for Modular Wall Readers. Base for surface mounting WRMBH1 included with the WRMFHAV.		
	Prices - Gross prices		€
	Description	Reference	
	Wall reader anti vandalic frame for modular wall readers (surface mounting)	W R M F H A V	52,80

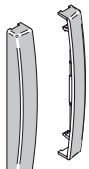
Model WRMFS	SALTO Spare concealed fixing covers for Modular Wall Readers.		
	Prices - Gross prices		€
	Description	Reference	
	Spare concealed fixing covers (per pair). Black finish	W R M F S B	3,90
	Spare concealed fixing covers (per pair). White finish	W R M F S W	
Spare concealed fixing covers (per pair). Silver finish	W R M F S S		

Model CU42E0x

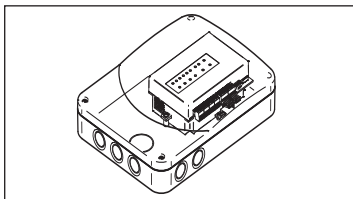

SALTO XS4 Controller - ethernet (with housing).
 Two reader option. To be used in combination with SALTO Readers range (WRDBxxx series).
 Connection up to 4 CU4200 control units by bus 485. 12V power supply included.

Prices - Gross prices		€
Description	Reference	
SALTO XS4 Controller - ethernet Grey housing	C U 4 2 E 0 G *	835,90
SALTO XS4 Controller ethernet Translucent housing	C U 4 2 E 0 T *	835,90

Model CU42E0

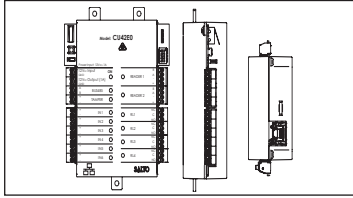

SALTO XS4 Controller - ethernet.
 Two reader option. To be used in combination with SALTO Readers range (WRDBxxx series).
 Connection up to 4 CU4200 control units by bus 485. 12V power supply included.

Prices - Gross prices		€
Description	Reference	
SALTO XS4 Controller - ethernet	C U 4 2 E 0 *	835,90

Model CU4200x

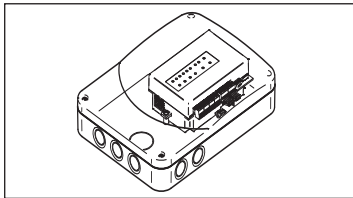

SALTO XS4 Controller - auxiliary (with housing).
 Two reader option. To be used in combination with SALTO Readers range (WRDBxxx series).
 Can work offline, or online linked to a CU42E.12V power supply included.

Prices - Gross prices		€
Description	Reference	
SALTO XS4 Controller - auxiliary Grey housing	C U 4 2 0 0 G	417,95
SALTO XS4 Controller - auxiliary Translucent housing	C U 4 2 0 0 T	417,95

Model CU4200

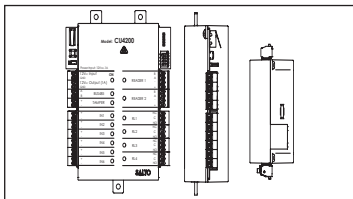

SALTO XS4 Controller - auxiliary.
 Two reader option. To be used in combination with SALTO Readers range (WRDBxxx series).
 Can work offline, or online linked to a CU42E.12V power supply included.

Prices - Gross prices		€
Description	Reference	
SALTO XS4 Controller - auxiliary	C U 4 2 0 0 *	417,95

* If you want the CU with a power adaptor for your region the reference must finish by:
 EU = EU power adaptor US = US power adaptor
 UK = UKpower adaptor AUS = Australian power adpator

Model SPCU4BOXx

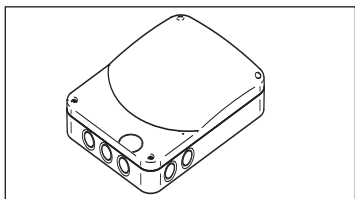

SALTO XS4 Controller - housing.
 Housing box for CU42xx Controllers.
 Fixing accessories included.

Prices - Gross prices		€
Description	Reference	
SALTO XS4 Controller - Grey housing	S P C U 4 B O X G	33,20
SALTO XS4 Controller - Translucent housing	S P C U 4 B O X T	33,20

Model SP224861

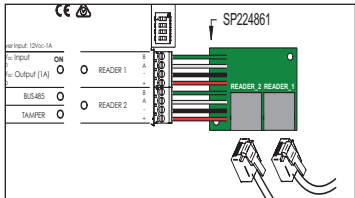

SALTO XS4 Controller RJ45 CU42xx connecting circuit adaptor.
 Connecting circuit RJ45 cable adaptor for CU42E0 or CU4200.
 For Reader 1 and Reader 2.

Prices - Gross prices		€
Description	Reference	
RJ45 CU42xx connecting circuit adaptor	S P 2 2 4 8 6 1	36,15

Model SP224895

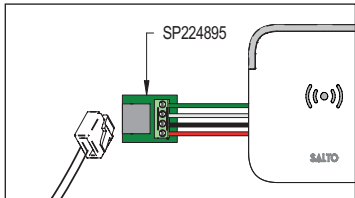

SALTO XS4 Controller RJ45 WRDBxxx connecting circuit adaptor.
 Connecting circuit adaptor for RJ45 cable for WRDBxxx series.
 For one wall reader.

Prices - Gross prices		€
Description	Reference	
RJ45 WRDBxxx connecting circuit adaptor	S P 2 2 4 8 9 5	36,15

Model CU4EB8

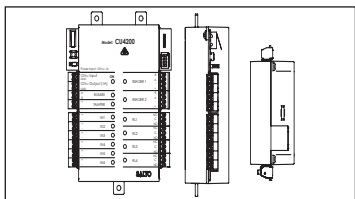

SALTO XS4 Controller - input / output expansion unit.
 8 relay outputs, 4 inputs. To be used in combination with XS4 Controller (CU4200).
 12V power supply included.

Prices - Gross prices		€
Description	Reference	
SALTO XS4 Controller - input / output expansion unit.	C U 4 E B 8 *	359,40

* If you want the CU with a power adaptor for your region the reference must finish by:
 EU = EU power adaptor
 UK = UKpower adaptor
 US = US power adaptor
 AUS = Australian power adpator

Model CU4EB8x

SALTO XS4 Controller - input / output expansion unit with housing.
 8 relay outputs, 4 inputs. To be used in combination with XS4 Controller (CU4200).
 12V power supply included. Fixing accessories included.

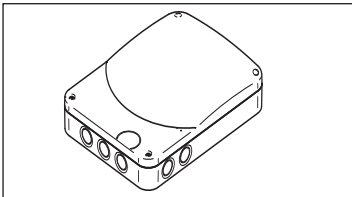

Prices - Gross prices		€
Description	Reference	
SALTO XS4 Controller - input / output expansion unit Grey housing	C U 4 E B 8 G *	359,40
SALTO XS4 Controller - input / output expansion unit Translucent housing	C U 4 E B 8 T *	359,40



Model WRLUD1

SALTO XS4 UHF Long Distance Reader. Up to 3 meters distance reading. To be used with CU42E0 controller. Needs a WRLUD-SIC1 to be connected to the CU. Cable and WRLUD-SIC1 not included.

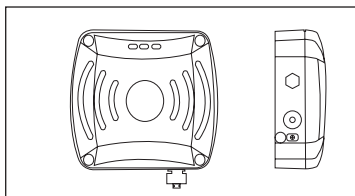

Prices - Gross prices		€
Description	Reference	
WRLUD1 - European frequency compliant	W R L U D 1 4 B E U	1409,50

Model WRLUD2

SALTO XS4 UHF Long Distance Reader. Up to 7 meters distance reading. To be used with CU42E0 controller. Needs a WRLUD-SIC1 to be connected to the CU. Mounting bracket included. Cable and WRLUD-SIC1 not included.

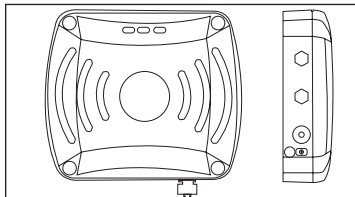

Prices - Gross prices		€
Description	Reference	
WRLUD2 - European frequency compliant	W R L U D 2 4 B E U	1567,70
WRLUD2 - US frequency compliant	W R L U D 2 4 B U S	
WRLUD2 - Australian frequency compliant	W R L U D 2 4 B A U S	

Model WRLUD-SIC1

SALTO XS4 UHF Long Distance Reader SIC module.
LD Reader - CU42E0 Wiegand signal converter device.

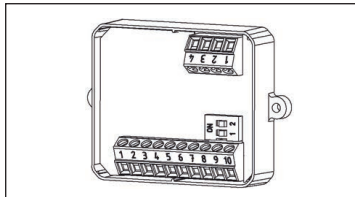

Prices - Gross prices		€
Description	Reference	
WRLUD-SIC1 - Wiegand signal converter	W R L U D - S I C 1	179,80

The Prices for the SALTO Long distance reader and its accessories are subject to own discount rates.
For details, please contact the SALTO sales office.

Model WRLUD-C10	SALTO XS4 UHF Long Distance Reader 10 meters cable. Connection cable - 10m with 4 pin connector.
------------------------	---

Prices - Gross prices		€
Description	Reference	
WRLUD-C10 - Connection cable with connector - 10m length - 10m length	W R L U D - C 1 0	83,40

Model WRLUD-4PC	SALTO XS4 UHF Long Distance Reader 4 pin connector. Connector spare part (included with the WRLUD1 and WRLUD2 references).
------------------------	---

Prices - Gross prices		€
Description	Reference	
WRLUD-4PC - 4 pin connector for WRLUD wall readers	W R L U D - 4 P C	56,25

Model WRLUD-MB4	SALTO XS4 UHF Long Distance Reader reader mounting base. Fixing screws to the wall included.
------------------------	---

Prices - Gross prices		€
Description	Reference	
WRLUD-MB4 - Mounting base for WRLUD wall readers	W R L U D - M B 4	242,00

Model WRLUD-SNG3	SALTO XS4 UHF Long Distance Reader USB to RS485 converter. Maintenance tool to change default channel configuration. Needs a WRLUD-PS24.
-------------------------	---

Prices - Gross prices		€
Description	Reference	
WRLUD-SNG3 - USB to RS485 converter	W R L U D - S N G 3	271,85

The Prices for the SALTO Long distance reader and its accessories are subject to own discount rates.
For details, please contact the SALTO sales office.

Model WRLUD-PS24	SALTO XS4 UHF Long Distance Reader 24V power supply for converter. To be used with the WRLUDS-NG3 converter tool.
-----------------------------------	--

Prices - Gross prices		€
Description	Reference	
WRLUD-PS24 - 24V power supply for WRLUD-SNG3 converter	W R L U D - P S 2 4	194,20

Model WRLUD-POC08	SALTO XS4 UHF Long Distance Reader POC-UHF field detector. Single led test tool to check the UHF signal.
--------------------------	---

Prices - Gross prices		€
Description	Reference	
WRLUD-POC08 - POC-UHF field detector for WRLUD wall readers	W R L U D - P O C 0 8	172,60

Model WRLUD-4TT08	SALTO XS4 UHF Long Distance Reader set of 4 test transponders. 4 cards test tool kit: 100% / 66% / 33% / "Test-Mode On" transponders.
--------------------------	--

Prices - Gross prices		€
Description	Reference	
WRLUD-4TT08 - Set of 4 test transponders for WRLUD wall readers	W R L U D - 4 T T 0 8	174,80

WRLUD Credentials	SALTO XS4 UHF Long Distance Reader credentials. Special combi credentials 8 bytes UHF + RFID technology
--------------------------	--

Prices - Net price - no discount		€
Description	Reference	
Combi cards DESFire EV1 8 kbytes and UHF 8 bytes for SALTO WRLUD readers. SALTO Design. UHF UID printed on the card.	P C D 0 8 K U H 8	11,45
Combi cards MIFARE 4 kbytes and UHF 8 bytes for SALTO WRLUD readers. SALTO Design. UHF UID printed on the card.	P C M 0 4 K U H 8	9,50
Windshield transponder ISO-Format UHF 8 bytes for SALTO WRLUD readers. White neutral. UHF UID printed on the card.	P W U 0 0 8 B	5,95
On metal transponder ISO-Format UHF 8 bytes for SALTO WRLUD readers. White neutral. UHF UID printed on the card.	P M U 0 0 8 B	17,65

The Prices for the SALTO Long distance reader and its accessories are subject to own discount rates.
For details, please contact the SALTO sales office.

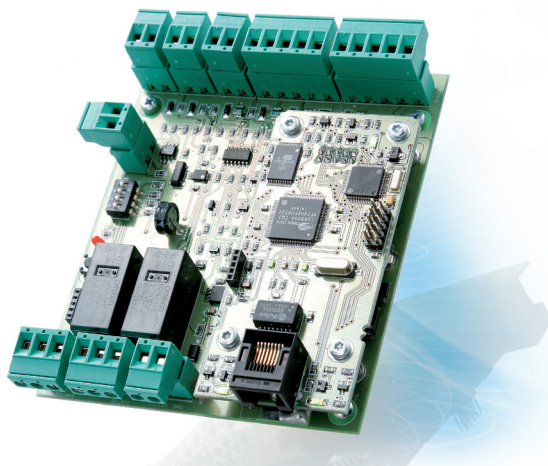

Model CU5000

SALTO Read-Write offline control unit.
In & out reader options.
2 relay outputs. To be used with WR2000, WR7000, WR8000, WR9000 and WRH000 ranges.

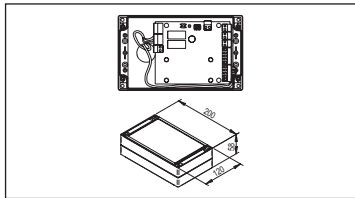

Prices - Gross prices		€
Description	Reference	
SALTO Read-Write offline control unit	C U 5 0 0 0 *	521,25

Model CU50EN

SALTO Read-Write online control unit.
In & out reader options. 2 relay outputs, IP connection.
To be used with WR2000, WR7000, WR8000, WR9000 and WRH000 ranges.

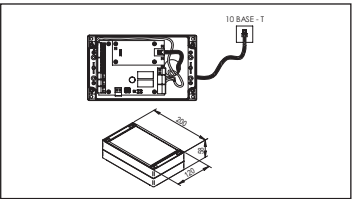

Prices - Gross prices		€
Description	Reference	
SALTO Read-Write online control unit	C U 5 0 E N *	745,90

Model CU50ENSVN

SALTO Read-Write online control unit with SALTO Virtual Network capabilities.
In & out reader options. 2 relay outputs, IP connection.
To be used with WR2000, WR7000, WR8000, WR9000 and WRH000 ranges.

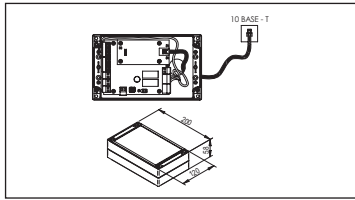

Prices - Gross prices		€
Description	Reference	
SALTO Read-Write SVN online control unit	C U 5 0 E N S V N *	835,90

* if you want the CU with a power adaptor for your region just end the reference by:
 UK = without power adaptor
 UK2 = withUK power adaptor
 US = US power adaptor
 AUS = Australian power adaptor

Model PB212S

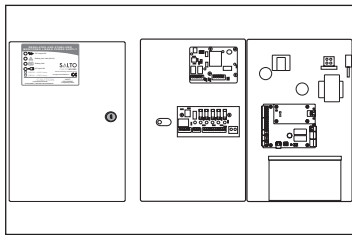

PB212S-50 (One CU5000).
 PB212S-SV (One CU50ENSVN)
 Emergency battery not supplied

SALTO Power supply electric box 1 control unit.
 Input Voltage: 220 - 240 VAC 50Hz - Output Voltage: 12VDC 2 amp
 Dimensions: 335 high x 225mm wide x 85mm depth.

Prices - Gross prices						€
Model	Input voltage	Output voltage	Box size	Primary device	Secondary device	
PB	2 220-240 VAC 50Hz	12 12 VDC 2amp	S Small	-	-	369,70
PB	2 220-240 VAC 50Hz	12 12 VDC 2amp	S Small	50 CU5000	-	891,00
PB	2 220-240 VAC 50Hz	12 12 VDC 2amp	S Small	SV CU50ENSVN	-	1205,55

Model PB212L

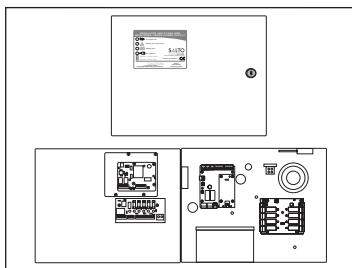

PB212L-50 (One CU5000)
 PB212L-SV (One CU50ENSVN)
 PB212L-50EB (One CU5000 and one EB5008)
 PB212LSVEB (One CU50ENSVN and one EB5008)
 Emergency battery not supplied

SALTO Power supply electric box for 1 control unit and one relay extension board. Input Voltage: 220 - 240 VAC 50Hz - Output Voltage: 12VDC 2 amp.
 Dimensions: 310 high x 410mm wide x 100mm depth.

Prices - Gross prices						€
Model	Input voltage	Output voltage	Box size	Primary device	Secondary device	
PB	2 220-240 VAC 50Hz	12 12 VDC 2amp	L Large	-	-	424,30
PB	2 220-240 VAC 50Hz	12 12 VDC 2amp	L Large	50 CU5000	-	945,55
PB	2 220-240 VAC 50Hz	12 12 VDC 2amp	L Large	SV CU50ENSVN	-	1260,25
PB	2 220-240 VAC 50Hz	12 12 VDC 2amp	L Large	SV CU50ENSVN	SV CU50ENSVN	2096,10
PB	2 220-240 VAC 50Hz	12 12 VDC 2amp	L Large	50 CU5000	EB EB5008	1305,05
PB	2 220-240 VAC 50Hz	12 12 VDC 2amp	L Large	SV CU50ENSVN	EB EB5008	1619,55

Model EB5008

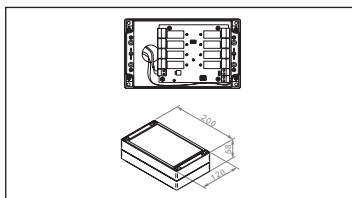

SALTO Relay extension board (8 relays).
 E.g. for managing elevators. Can be connected to 16 relay extension board (128 outputs).

Prices - Gross prices		€
Description	Reference	
Relay extension board EB5008	E B 5 0 0 8	359,40

Model WRADAP

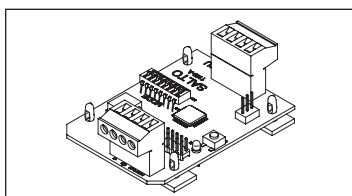

SALTO wall reader PC board adapter.
 PC board adapter, in order to allows SALTO wall readers to connect to external systems.

Prices - Gross prices		€
Description	Reference	
SALTO wall reader PC board adapter	W R A D A P	162,85

Model CUADAP

SALTO Control unit PC board adapter,
PC board adapter, in order to allows SALTO control units to connect to external systems.

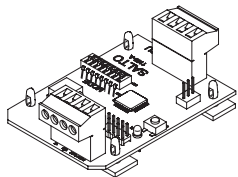

Prices - Gross prices

Description	Reference	€
SALTO control unit PC board adapter	C U A D A P	110,00

Model CU5EN-PCB

SALTO Ethernet EN-PCB allows CU5000 to upgrade to a CU50EN.
Dimensions: 9,5 x 4,5 cm.

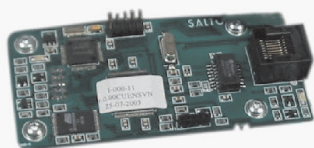

Prices - Gross prices

Description	Reference	€
SALTO Ethernet EN- PCB	C U 5 E N - P C B	318,95

**Model
CU5SVN-PCB**

SALTO Ethernet EN-PCB allows CU5000 or CU50EN to upgrade to a CU50ENSVN.
Dimensions: 9,5 x 4,5 cm.

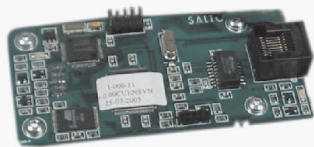

Prices - Gross prices

Description	Reference	€
SALTO Ethernet ENSVN - PCB	C U 5 S V N - P C B	409,00

**UBOX 8000
Legic Advant**

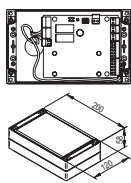

SALTO Updater kit.
Updater kit for integrations. To be used only on integration projects with integrated systems.
Includes Modular wall reader WRM8000, Ubox and CU adaptor.

Prices - Net price - no discount		€
Description	Reference	
Legic Advant SALTO Updater kit	U B O X 8 0 0 0	201,00

**UBOX 8001
Legic Advant**

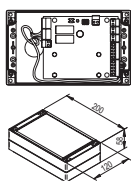

SALTO Updater kit.
Updater kit for integrations. To be used only on integration projects with integrated systems.
Includes Modular wall reader WRM8001, Ubox and CU adaptor.

Prices - Net price - no discount		€
Description	Reference	
Legic Advant SALTO Updater kit	U B O X 8 0 0 1	201,00

**UBOX 9000
Mifare DESFire**

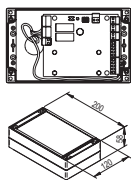

SALTO Updater kit.
Updater kit for integrations. To be used only on integration projects with integrated systems.
Includes Modular wall reader WRM9000, Ubox and CU adaptor.

Prices - Net price - no discount		€
Description	Reference	
Mifare SALTO Updater kit	U B O X 9 0 0 0	201,00

**UBOX 9001
Mifare DESFire**

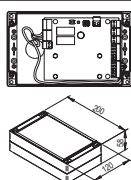

SALTO Updater kit.
Updater kit for integrations. To be used only on integration projects with integrated systems.
Includes Modular wall reader WRM9001, Ubox and CU adaptor.

Prices - Net price - no discount		€
Description	Reference	
Mifare SALTO Updater kit	U B O X 9 0 0 1	201,00



If the reader need to be samed with the Integrators SAM codes, please contact SALTO.

**UBOX H000
HID ICLASS**

SALTO Updater kit.
Updater kit for integrations. To be used only on integration projects with integrated systems.
Includes Modular wall reader WRMH000, Ubox and CU adaptor.

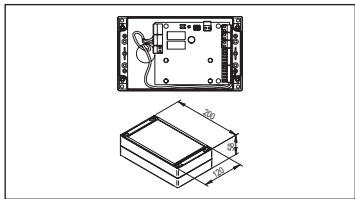

Prices - Net price - no discount		€
Description	Reference	
HID iCLASS SALTO Updater kit	U B O X H 0 0 0	275,40

Updater kit UBOX

SALTO Updater kit.
Updater kit for integrations. To be used only on integration projects with integrated systems.
Includes Ubox and CU adaptor.

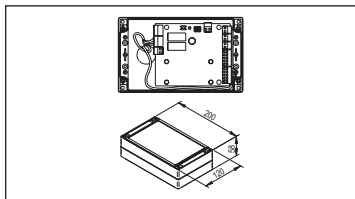

Prices - Net price - no discount		€
Description	Reference	
SALTO Updater kit	U P D A T E R 0 1	213,75

* if you want the WRADAP with an power adaptor for your region just end the reference by:
UK = UK power adaptor
US = US power adaptor
AUS = Australian power adaptor



If the reader need to be samed with the Integrators SAM codes, please contact SALTO.



Model EPS100

Emergency power supply

Smile emergency power supply battery back for AAA batteries (not included).



Prices - Gross prices		€
Description	Reference	
SALTO SMILE emergency power supply	E P S 1 0 0	38,25

Model PPD800

SALTO Portable Programming Device (PPD).

Contactless capabilities for compatibility with XS4 products.
Cable included to connect to the lock. USB connection to the PC.

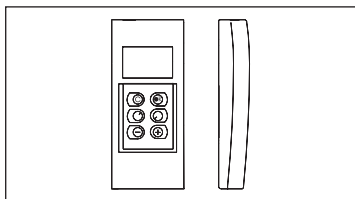

Prices - Gross prices		€
Description	Reference	
SALTO PPD	P P D 8 0 0	526,70

SP226093

PPD cable for ÆElement Fusion*

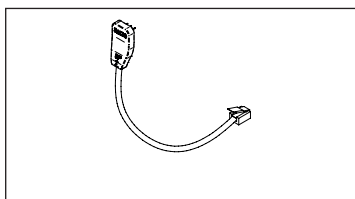

Prices - Gross prices		€
Description	Reference	
PPD cable for ÆElement Fusion	S P 2 2 6 0 9 3	11,35

* Works with ÆElement also

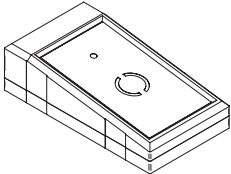
Model EC7000	SALTO proximity card encoder Picopass. RS232 connection.		
	Prices - Gross prices		€
	Description	Reference	
	SALTO serial proximity card encoder	E C 7 0 0 0 *	615,10

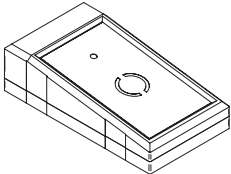
Model EC70USB	SALTO proximity card encoder Picopass. USB connection. Powered by the USB port. No power adaptor needed.		
	Prices - Gross prices		€
	Description	Reference	
	SALTO USB proximity card encoder	E C 7 0 U S B	615,10

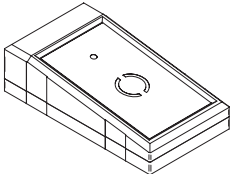
Model EC70EN	SALTO proximity card encoder Picopass. Ethernet connection.		
	Prices - Gross prices		€
	Description	Reference	
	SALTO Ethernet proximity card encoder	E C 7 0 E N *	840,25

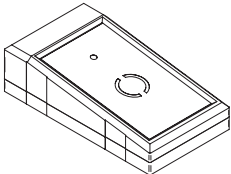
Model EC70DR	SALTO proximity card desktop reader Picopass. Serial port connection. Data read by the desktop reader: ROM code, Tracks on key, Wiegand code.		
	Prices - Gross prices		€
	Description	Reference	
	SALTO serial proximity card desktop reader	E C 7 0 D R *	701,60

* if you want the encoder with a power adaptor for your region just end the reference by:
 UK = UK power adaptor
 US = US power adaptor
 AUS = Australian power adaptor

Model PPD800

SALTO Portable Programming Device (PPD).
Contactless capabilities for compatibility with XS4 products.
Cable included to connect to the lock. USB connection to the PC.

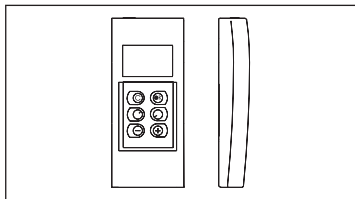

Prices - Gross prices		€
Description	Reference	
SALTO PPD	P P D 8 0 0	526,70

Model EC8000

SALTO proximity card encoder LEGIC.
RS232 connection.

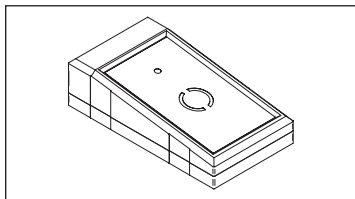

Prices - Gross prices		€
Description	Reference	
SALTO serial proximity card encoder	E C 8 0 0 0 *	615,15

Model EC80USB

SALTO proximity card encoder LEGIC.
USB connection. Powered by the USB port. No power adaptor needed.

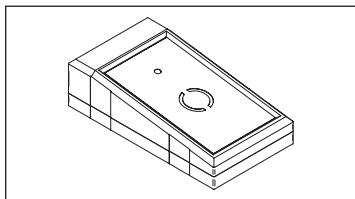

Prices - Gross prices		€
Description	Reference	
SALTO USB proximity card encoder	E C 8 0 U S B	615,15

Model EC80EN

SALTO proximity card encoder LEGIC.
Ethernet connection.

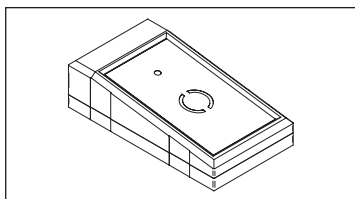

Prices - Gross prices		€
Description	Reference	
SALTO Ethernet proximity card encoder	E C 8 0 E N *	840,25

Model EC80DR

SALTO proximity card desktop reader LEGIC.
Serial port connection.
Data read by the desktop reader: ROM code, Tracks on key, Wiegand code.

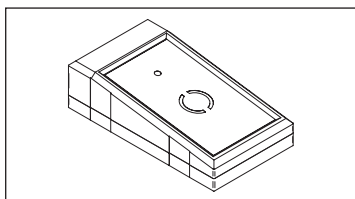

Prices - Gross prices		€
Description	Reference	
SALTO serial proximity card desktop reader	E C 8 0 D R *	701,65

* if you want the encoder with a power adaptor for your region just end the reference by:
UK = UK power adaptor
US = US power adaptor
AUS = Australian power adaptor

Model PPD800

SALTO Portable Programming Device (PPD).
Contactless capabilities for compatibility with XS4 products.
Cable included to connect to the lock. USB connection to the PC.

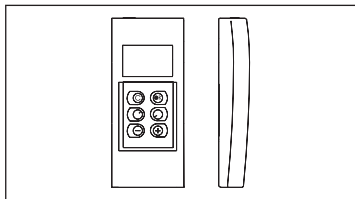

Prices - Gross prices		€
Description	Reference	
SALTO PPD	P P D 8 0 0	526,70

Model ECB04B0

NCode - Proximity card encoder Mifare/DESFire BLE.
USB and Ethernet connections. DHCP addressing. Desktop reader capabilities.

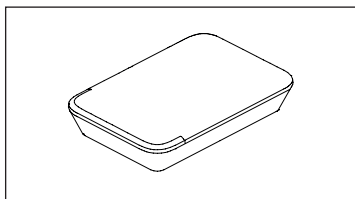

Prices - Gross prices		€
Description	Reference	
SALTO NCode - Encoder/Desktop reader	E C B 0 4 B 0 *	585,85

* if you want the encoder with a power adaptor for your region just end the reference by:
EU = EU power adaptor
UK = UK power adaptor
US = US power adaptor
AUS = Australian power adaptor

Model EC9000

SALTO proximity card encoder Mifare/DESFire.
RS232 connection.

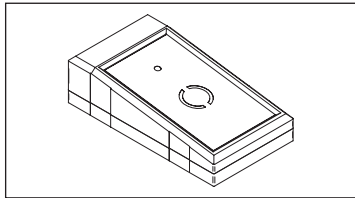

Prices - Gross prices		€
Description	Reference	
SALTO serial proximity card encoder	E C 9 0 0 0 *	585,85

Model EC90USB

SALTO proximity card encoder Mifare/DESFire.
USB connection. Powered by the USB port. No power adaptor needed.

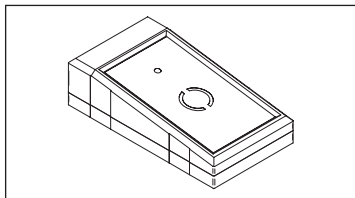

Prices - Gross prices		€
Description	Reference	
SALTO USB proximity card encoder	E C 9 0 U S B	585,85

* if you want the encoder with a power adaptor for your region just end the reference by:
UK = UK power adaptor
US = US power adaptor
AUS = Australian power adaptor

Model EC90EN

SALTO proximity card encoder Mifare/DESFire.
 Ethernet connection.

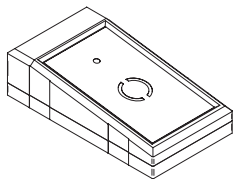

Prices - Gross prices		€
Description	Reference	
SALTO Ethernet proximity card encoder	E C 9 0 E N *	800,30

Model EC90DR

SALTO proximity card desktop reader Mifare/DESFire.
 Serial port connection.
 Data read by the desktop reader: ROM code, Tracks on key, Wiegand code.

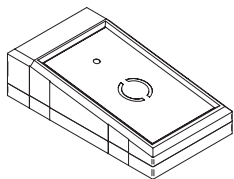

Prices - Gross prices		€
Description	Reference	
SALTO serial proximity card desktop reader	E C 9 0 D R *	668,20

* if you want the encoder with a power adaptor for your region just end the reference by:
 UK = UK power adaptor
 US = US power adaptor
 AUS = Australian power adaptor

Model PPD800

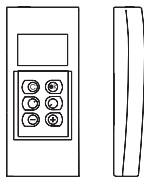

SALTO Portable Programming Device (PPD).
Contactless capabilities for compatibility with XS4 products.
Cable included to connect to the lock. USB connection to the PC.

Prices - Gross prices		€
Description	Reference	
SALTO PPD	P P D 8 0 0	526,70

Model ECJ04B0

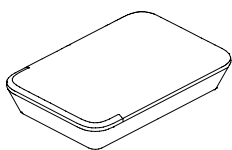

NCoder - Proximity card encoder iCLASS Seos BLE.
USB and Ethernet connections. DHCP addressing. Desktop reader capabilities.

Prices - Gross prices		€
Description	Reference	
SALTO NCoder - Encoder/Desktop reader	E C J 0 4 B 0 *	798,25

* if you want the encoder with a power adaptor for your region just end the reference by:
EU = EU power adaptor
UK = UK power adaptor
US = US power adaptor
AUS = Australian power adaptor

Model ECH000

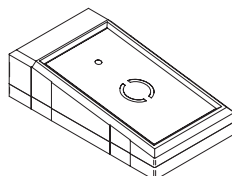

SALTO proximity card encoder HID i-CLASS.
RS232 connection.

Prices - Gross prices		€
Description	Reference	
SALTO serial proximity card encoder	E C H 0 0 0 *	798,25

Model ECH0USB

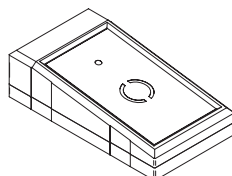

SALTO proximity card encoder HID i-CLASS.
USB connection. Powered by the USB port. No power adaptor needed.

Prices - Gross prices		€
Description	Reference	
SALTO USB proximity card encoder	E C H 0 U S B	798,25

* if you want the encoder with a power adaptor for your region just end the reference by:
UK = UK power adaptor
US = US power adaptor
AUS = Australian power adaptor

Model ECH0EN

SALTO proximity card encoder HID i-CLASS.
Ethernet connection.

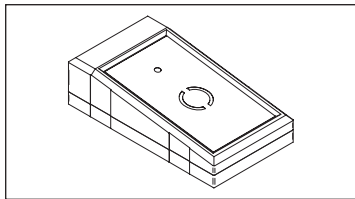

Prices - Gross prices		€
Description	Reference	
SALTO Ethernet proximity card encoder	E C H 0 E N *	1082,20

Model ECH0DR

SALTO proximity card desktop reader HID i-CLASS.
Serial port connection.
Data read by the desktop reader: ROM code, Tracks on key, Wiegand code.

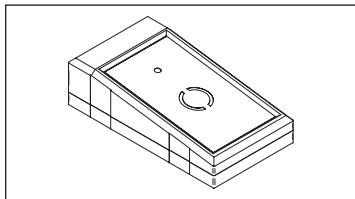

Prices - Gross prices		€
Description	Reference	
SALTO serial proximity card desktop reader	E C H 0 D R *	747,05

* if you want the encoder with a power adaptor for your region just end the reference by:
 UK = UK power adaptor
 US = US power adaptor
 AUS = Australian power adaptor



XS4 locker reference example

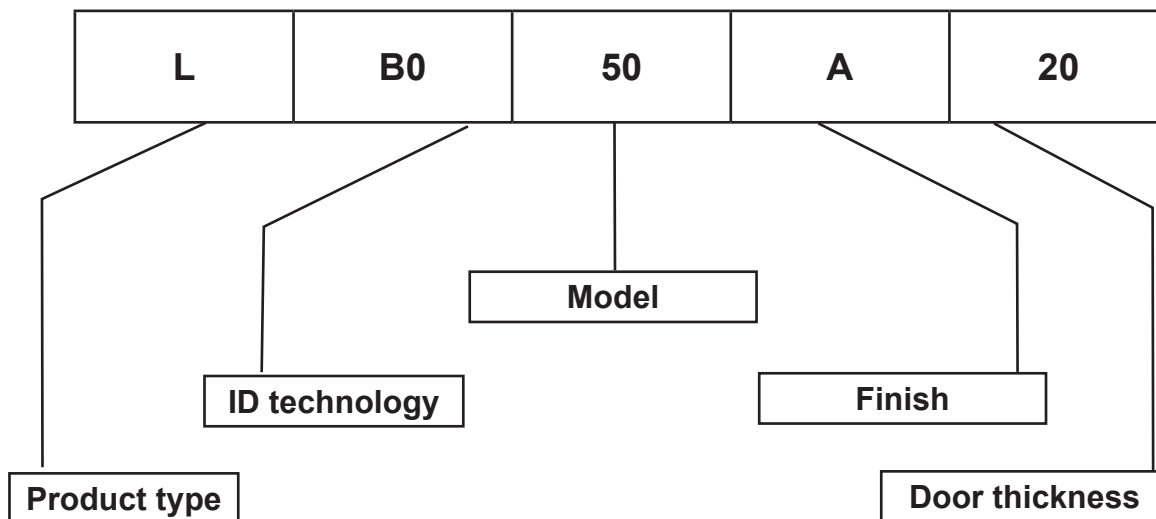

Product type:

L = locker lock

ID technology:

80 = Legic ADVANT
B0 =BLE DESFire MIFARE
J0 = BLE HID iCLASS Seos

Model:

50 = Standard Locker lock

Finish:

A = Anthracite inside and outside
M = Anthracite inside and white outside

Door thickness mm:

20 = 10-20mm 50 = 40-50mm
30 = 20-30mm
40 = 30-40mm

Model Lx050x

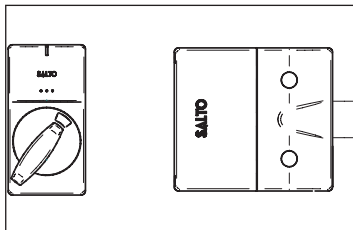

No handing, for Right hand and Left hand for door thickness >10mm

XS4 Locker Lock contactless

Surface mounting. Sandwich construction with reader on the outside and lock case on the inside. BioCoted antimicrobial technology inside.

Prices - Gross prices	€
Legic ADVANT - Prime - Standard price	227,25
BLE DESFire MIFARE - Standard price	207,05
BLE HID iCLASS Seos- Standard price	286,40

Product reference				
Product	Technology	Model	Finish	Door thickness
L	80	50	A	20 10-20mm
	Prox Legic ADVANT			30 20-30mm
	B0		M	40 30-40mm
	BLE DESFire MIFARE			50 40-50mm
J0	White reader Anthracite battery pack			
	BLE HID iCLASS Seos			



For orders over 100 lockers call SALTO to access special volume discounts.

XS4 Locker distance plates

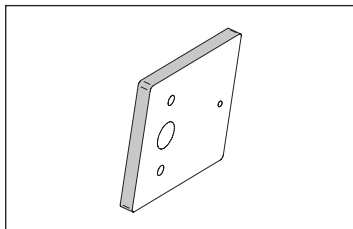

SALTO XS4 Locker distance plates.

Acc. Skirting board to fit any kind of Locker door.
For door thickness < 10mm

Prices - Gross prices		€
Description	Reference	
Plate thickness 10mm	S P 2 2 0 6 4 0	7,00

XS4 Locker distance plates

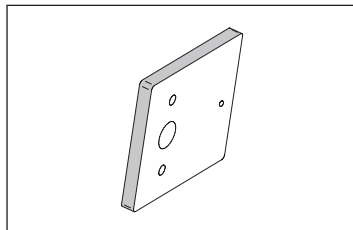

SALTO XS4 Locker distance plates.

Acc. Skirting board to fit any kind of Locker door.
For door thickness < 15mm

Prices - Gross prices		€
Description	Reference	
Plate thickness 15 mm	S P 2 2 0 6 4 0 - 1 5	7,00

Bolt enlarger

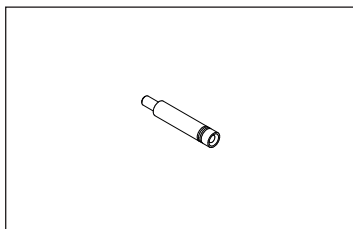

Bolt enlarger

For door thickness >40 mm

Prices - Gross prices		€
Description	Reference	
Bolt enlargers	S P 2 2 0 3 3 3 - 2 0	73,75



Model ESD9000

SALTO Energy Saver ESD9000.
Proximity Mifare / DESFire smart energy saver device. With 2 Micro Switches.
Output of 110V/ 16A - 220V/ 16A. Offline device.

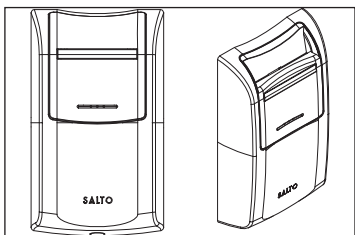

Time delay adjustable by software (5-60 seconds).

Indicator light for guidance of the card.

With window detector.

Prices - Gross prices	€
Proximity Mifare ESD offline with two outputs - Standard price.	268,95

Product reference				
Model	Outputs	Voltage	Finishes	Online device
ESD9	2 Two outputs	U Output of 110V / 16A. - 220V / 16A.	I Iron blue	- Offline
			C Gold champagne	

**Model ESD9000
online**

SALTO Energy Saver ESD9000.
Proximity Mifare / DESFire Smart Energy saver device. With 2 Micro Switches.
Output of 110V/ 16A - 220V/ 16A . Online device.

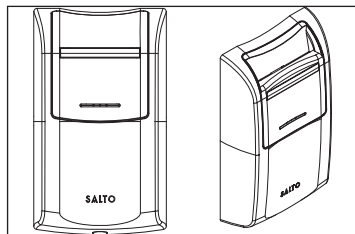

Time delay adjustable by software (5-60 seconds).

Indicator light for guidance of the card.

With window detector.

connection with the PC BUS 486 through one control unit as a hub.

Prices - Gross prices	€
Proximity Mifare ESD online with two outputs - Standard price.	319,05

Product reference				
Model	Outputs	Voltage	Finishes	Online device
ESD9	2 Two outputs	U Output of 110V / 16A. - 220V / 16A.	I Iron blue	C Online
			C Gold champagne	



		SPABASIC	SPAONLINE	SPAIDSYS	SPAPART	SPADEMO	SPATRIAL
	Users	4 000 000	4 000 000	4 000 000	4 000 000	20	4 000 000
	Doors	65 000	65 000	65 000	65 000	20	65 000
	Expiration period	No expiry	No expiry	No expiry	No expiry	No expiry	90 days
Functions							
	OPT-Nr						
Lockers	0001	Included	Included	Included	Included	Included	Included
Online Monitoring	0004	Included	Included	Included	Included	Included	Included
Lockdown	0005	Not included	Included	Included	Included	Included	Included
Antipassback	0006	Not included	Included	Included	Included	Included	Included
Event Stream	0007	Not included	Included	Included	Included	Included	Included
Automatic Key Assignment	0008	Not included	Included	Included	Included	Included	Included
Roll Call	0009	Not included	Included	Included	Included	Included	Included
Limited Occupancy	0010	Not included	Included	Included	Included	Included	Included
Card printing module	0012	Not included	Not included	Included	Included	Included	Included
Visitors management	0013	Possible add-on	Possible add-on	Included	Included	Included	Included
Department Operator	0011	Not included	Not included	Not included	Included	Included	Included
Locations & Function	0015	Possible add-on	Possible add-on	Possible add-on	Possible add-on	Included	Included
Mobile users module	0016	Possible add-on	Possible add-on	Possible add-on	Possible add-on	Included	Included
Database Synchronization	0017	Possible add-on	Possible add-on	Possible add-on	Possible add-on	Included	Included
SHIP Integration	0018	Possible add-on	Possible add-on	Possible add-on	Possible add-on	Included	Included
Graphical Mapping compatibility	0019	Possible add-on	Possible add-on	Possible add-on	Possible add-on	Included	Included
SAM Custom Keys	0020	Included	Included	Included	Included	Included	Included
SAM Custom Keys defined by user	0029	Possible add-on	Possible add-on	Possible add-on	Possible add-on	Not included	Not included
RFnet wireless	0021	Possible add-on	Possible add-on	Possible add-on	Possible add-on	Included	Included
Alarms & Communication	0032	Possible add-on	Possible add-on	Possible add-on	Possible add-on	Included	Included
SALTO BLUEnet wireless	0033	Possible add-on	Possible add-on	Possible add-on	Possible add-on	Included	Included
Elevator integration feature	0035	Possible add-on	Possible add-on	Possible add-on	Possible add-on	Included	Included
SALTO BLUEnet wireless Lockers	0036	Possible add-on	Possible add-on	Possible add-on	Possible add-on	Included	Included
Attendance Reporting	0037	Not included	Included	Included	Included	Included	Included
Hotel module	0022	Possible add-on	Possible add-on	Possible add-on	Possible add-on	Included	Included
BAS Integration	0023	Possible add-on	Possible add-on	Possible add-on	Possible add-on	Included	Included
Mobile Guest Keys	0028	Possible add-on	Possible add-on	Possible add-on	Possible add-on	Included	Included

SALTO ProAccess SPACE software - Basic package Access Control Management Software. Web-based Interface	Gross prices
--	--------------

Description	Reference	€
SALTO ProAccess SPACE software - Basic SALTO ProAccess SPACE software Web-based software with SALTO ProAccess service. Includes: - Basic access control management functions - Up to 4 000 000 users - 64 000 doors - Lockers management	S P A B A S I C	421,15

SALTO ProAccess SPACE software - Online package Access Control Management Software. Web-based Interface with Online module.	Gross prices
---	--------------

Description	Reference	€
SALTO ProAccess SPACE software - Online SALTO ProAccess SPACE software Web-based software with SALTO ProAccess service. Includes: - All the features included in the SALTO ProAccess SPACE Basic package, plus: - Additional features: Lockdown, Antipassback, Event Stream, Automatic Key Assignment, Roll Call, Limited Occupancy	S P A O N L I N E	787,00

SALTO ProAccess SPACE software - ID System package Access Control Management Software. Web-based Interface with Identification module.	Gross prices
--	--------------

Description	Reference	€
SALTO ProAccess SPACE software - ID System SALTO ProAccess SPACE software Web-based software with SALTO ProAccess service. Includes: - All the features included in the SALTO ProAccess SPACE Online package, plus: - Additional features: - Card printing module - Visitors management module	S P A I D S Y S	1623,85

SALTO ProAccess SPACE software - Partitional package Access Control Management Software. Web-based Interface with department operator capabilities.	Gross prices
---	---------------------

Description	Reference	€
SALTO ProAccess SPACE software - Partition SALTO ProAccess SPACE software Web-based access control software with SALTO ProAccess service. Includes: <ul style="list-style-type: none"> - All the features included in the SALTO ProAccess SPACE ID System package - Partitional functionalities (department operator) 	S P A P A R T	1900,95

SALTO ProAccess SPACE software - DEMO - DEMO purposes Access Control Management Software. Web-based Interface - DEMO	Net Price
--	------------------

Description	Reference	€
SALTO ProAccess SPACE software - DEMO SALTO ProAccess SPACE software Web-based access control software with SALTO ProAccess service. Includes: <ul style="list-style-type: none"> - Up to 20 users and 20 doors - Unlimited functionalities 	S P A D E M O	72,80

SALTO ProAccess SPACE software - Trial - Trial purposes Access Control Management Software. Web-based Interface -	Net Price
---	------------------

Description	Reference	€
SALTO ProAccess SPACE software - Trial SALTO ProAccess SPACE software Web-based access control software with SALTO ProAccess service. Includes: <ul style="list-style-type: none"> - Unlimited functionalities - 90 days Expiration 	S P A T R I A L	0,00

SALTO Graphical mapping software Interface for ProAccess SPACE software	Gross prices
--	---------------------

Description	Reference	€
SALTO Graphical Mapping Interface. To be used with SALTO ProAccess SPACE software	G M I 4 S P A C E	1141,90

SALTO ProAccess SPACE software - additional features Features that can be ordered separately to customise your version of ProAccess SPACE.		Gross prices
Description	Reference	€
<p>SALTO ProAccess SPACE software - Matrix location and functions</p> <p>The combination of users to doors and their different functions can cause occasionally keying problems when setting out the access plan. The Matrix Access Function simplifies and streamlines the link between users and doors making access planning simple and straightforward.</p> <p>Feature only available individually and is not included in any package</p>	SPACE - OPT - 0015	221,65
<p>SALTO ProAccess SPACE software - SALTO Mobile Users (JustIN mSVN (Mobile SVN - JustIN Mobile for users))</p> <p>SALTO Mobile Users permits the use of the SALTO mobile platform to users to have their credential on their smartphones through justIN mobile technology or to update their credentials through their smartphones through JustINmSVN technology.</p> <p>Feature included in all packages the first year - subject to yearly renovation Price per user/year</p>	SPACE - OPT - 0016 - 1	2,20
<p>SALTO ProAccess SPACE software - Data base synchronization</p> <p>Data base synchronization feature establish the link between databases and the ability to integrate different applications into different databases.</p> <p>Feature only available individually and is not included in any package</p>	SPACE - OPT - 0017	110,90
<p>SALTO ProAccess SPACE software - SHIP interface</p> <p>The SALTO Host Interface protocol enables users to integrate their SALTO Access Control system to other systems i.e. CCTV, fire alarm, traditional access control, etc all via the same software.</p> <p>Feature only available individually and is not included in any package</p>	SPACE - OPT - 0018	221,65
<p>SALTO ProAccess SPACE software - Graphical mapping</p> <p>Graphical mapping is a visual interface that permits monitorization of useres' access to online wired and wireless access points in realtime throughout the building lay out.</p> <p>Feature only available individually and is not included in any package Needs to be purchase with software GMI4SPACE</p>	SPACE - OPT - 0019	0,00
<p>SALTO ProAccess SPACE software - SAM Custom keys</p> <p>SAM Custom keys permit you to enbed on your system your SAM codes, and release them onto the SALTO devices through the PPD just by initializing the devices.</p> <p>Feature only available individually and is not included in any package Needs to be purchased with SAMKIT</p>	SPACE - OPT - 0020	Included
<p>SALTO ProAccess SPACE software - SAM Custom keys defined by user</p> <p>SAM Custom keys defined by user permits you to define your own SAM codes in order to increase the security.</p> <p>Feature only available individually and is not included in any package</p>	SPACE - OPT - 0029	Upon request

SALTO ProAccess SPACE software - additional features		Gross prices
Features that can be ordered separately to customise your version of ProAccess SPACE.		
Description	Reference	€
<p>SALTO ProAccess SPACE software - SALTO Wireless RFnet</p> <p>This feature permits you to enable the communication RFnet between your system and SALTO wireless online RFnet locks and cylinders.</p> <p>Feature only available individually and is not included in any package</p>	SPACE - OPT - 0021	55,40
<p>SALTO ProAccess SPACE software - Visitors module</p> <p>The Visitor module enables you to issue visitor cards for a few hours, a few days or for something in between, and all with a built-in cancellation date that will disable the credential automatically.</p> <p>Features included in the SALTO ProAccess SPACE ID System package</p>	SPACE - OPT - 0013	140,55
<p>SALTO ProAccess SPACE software - SALTO event-alarms & communication module</p> <p>This feature permits you to enable event alarms and also send emails to the operators generated by the events</p> <p>Feature only available individually and is not included in any package</p>	SPACE - OPT - 0032	532,65
<p>SALTO ProAccess SPACE software - SALTO Wireless BLUEnet</p> <p>The SALTO Wireless BLUEnet feature permits ProAccess SPACE Software to enable BLUEnet locks to convert them into Wireless online locks.</p> <p>Feature only available individually and is not included in any package Price per door. Not subject to yearly renovation.</p>	SPACE - OPT - 0033	62,65
<p>SALTO ProAccess SPACE software - Elevator feature</p> <p>This feature permits you to enable the elevators communication module to manage systems like Schindler PORT protocole.</p> <p>Feature only available individually and is not included in any package</p>	SPACE - OPT - 0035	522,25
<p>SALTO ProAccess SPACE software - SALTO Wireless BLUEnet Lockers</p> <p>The SALTO Wireless BLUEnet feature permits ProAccess SPACE Software to enable the lockers to be connected to the BLUEnet wireless network.</p> <p>Feature only available individually and is not included in any package Price per door. Not subject to yearly renovation.</p>	SPACE - OPT - 0036	10,00

SALTO ProAccess SPACE software - additional features Features that can be ordered separately to customise your version of ProAccess SPACE.		Gross prices
Description	Reference	€
Hotel features		
SALTO ProAccess SPACE software - Hotel The SALTO Hotel module is a special feature designed for the hospitality industry and enables your SALTO ProAccess SPACE software to work with rooms, guests, suites Group check-in, Rerooming through RF, Extended stay through RF Feature only available individually and is not included in any package	SPACE - OPT - 0022	0,00
SALTO ProAccess SPACE software - BAS Interface SALTO BAS Integration permits the integration of SALTO wireless electronic locks with Building Automation Systems. Please consult SALTO about the different BMS integrations available. Feature must be ordered with hotel function SPACE-OPT-0022	SPACE - OPT - 0023	554,20
SALTO ProAccess SPACE software - JustIN Mobile guest keys JustIN Mobile allow hotel guests to use their BLE-enabled smartphone to receive keys and open assigned doors. Feature included in all packages with SPACE-OPT-0022 for the first year after purchase and is subject to yearly renovation - Price shown per room per year.	SPACE - OPT - 0028 - 1	13,10
SALTO ProAccess SPACE software - JustIN Mobile guest keys subscription renewal fee JustIN Mobile allows hotel guests to use their BLE-enabled smartphone and receive keys to open assigned doors. Mobile guest keys function yearly renovation fee.	SPACE - OPT - 0028 - 2	325,95

SALTO Pro Access ROM software Access Control Management Software for ROM systems.		Gross prices
Description	Reference	€
ROM Pro Access. 20 Up-to 20 users.	P A 0 0 2 0	269,60
ROM Pro Access 100. Up-to 100 users.	P A 0 1 0 0	431,45
ROM Pro Access 500. Up-to 500 users.	P A 0 5 0 0	629,30
ROM Pro Access 1000. Up-to 1.000 users.	P A 1 0 0 0	898,70

SALTO Pro Access RW software Access Control Management Software for read and write systems.		Gross prices
Description	Reference	€
RW Pro Access 100. Up-to 100 users. 4 on line doors.	P A 1 0 0 R W	338,25
RW Pro Access 500. Up-to 500 users. 8 on line doors.	P A 5 0 0 R W	527,05
RW Pro Access Excellence. Up-to 64.000 Users. 16 on line doors.	P A E X C R W	784,40
RW Pro Access Connected. Up-to 64.000 users. Unlimited on line doors. Online features.	P A C O N R W	1534,90
RW Pro Access Connected SHIP. Up-to 64.000 users. Unlimited on line doors. Online features. SHIP protocol included.	P A C O N R W S	4403,75
RW Pro Access Department Operator. Up-to 64.000 users. Unlimited on line doors. Online features.	P A D E P R W	2648,95
RW Pro Access Department Operator SHIP. Up-to 64.000 users. Unlimited on line doors. Online features. SHIP protocol included.	P A D E P R W S	5571,30

SALTO Pro Access RW software MS SQL compatible Access Control Management Software for read and write systems for MS SQL Server data bases.		Gross prices
Description	Reference	€
RW Pro Access 100 SQL. Up-to 100 users. 4 on line doors. Unlimited wireless doors.	N P A 1 0 0	338,25
RW Pro Access 500 SQL. Up-to 500 users. 8 on line doors. Unlimited wireless doors.	N P A 5 0 0	527,05
RW Pro Access Excellence SQL. Up-to 4.000.000 Users. 16 on line doors. Unlimited wireless doors.	N P A E X C	784,40
RW Pro Access Connected SQL. Up-to 4.000.000 users. Online features. Unlimited on line doors.	N P A C O N	1534,90
RW Pro Access Connected SQL SHIP. Up-to 4.000.000. Online features. Unlimited on line doors. SHIP protocol included.	N P A C O N S H	4403,75
RW Pro Access Department Operator SQL. Up-to 4.000.000. Online features. Unlimited on line doors.	N P A D E P	2648,95
RW Pro Access Department Operator SQL On line SHIP. Up-to 4.000.000. Online features. Unlimited on line doors. SHIP protocol included.	N P A D E P S H	5571,30

SALTO Pro Access RW Microsoft SERVICE software Access Control Management Software for RW systems. Based on Microsoft Service		Gross prices
Description	Reference	€
RW Pro Access Connected for Service. Up-to 4.000.000 users. Online features. Unlimited on line doors. SHIP protocol included.	N P A C O N 4 S	1534,90
RW Pro Access Connected Plus for Service Up-to 4.000.000 users. Online features. Unlimited on line doors. Badging functionalities. SHIP protocol included.	N P A C + N 4 S	2229,60
RW Pro Access Department Operator for Service Up-to 4.000.000 users. Online features. Unlimited on line doors. Department Operator functionalities. SHIP protocol included.	N P A D E P 4 S	2648,95

SALTO HAMS RW software HOTEL Access Management Software for read and write systems.		Gross prices
Description	Reference	€
RW HAMS 100. Up-to 100 users. 4 on line doors.	H A M S 1 0 0	191,65
RW HAMS 500. Up-to 500 users. 8 on line doors.	H A M S 5 0 0	380,45
RW HAMS Excellence. Up-to 64.000 Users. 16 on line doors.	H A M S E X C	637,75
RW HAMS Connected. Up-to 64.000 users. Unlimited on line doors. Online features.	H A M S C O N	1388,15
RW HAMS Connected SHIP. Up-to 64.000 users. Unlimited on line doors. Online features. SHIP protocol included.	H A M S C O N S	4403,75
RW HAMS Department Operator. Up-to 64.000 users. Unlimited on line doors. Online features.	H A M S D E P	2502,10
RW HAMS Department Operator SHIP. Up-to 64.000 users. Unlimited on line doors. Online features. SHIP protocol included.	H A M S D E P S	5571,30

SALTO HAMS RW software MS SQL compatible HOTEL Access Management Software for read and write systems for MS SQL Server data bases.		Gross prices
Description	Reference	€
RW HAMS 100. Up-to 100 users SQL. Up-to 100 users. 4 on line doors. Unlimited wireless doors.	N H A 1 0 0	191,65
RW HAMS 100. Up-to 500 users SQL. Up-to 500 users. 8 on line doors. Unlimited wireless doors.	N H A 5 0 0	380,45
RW HAMS Excellence SQL. Up-to 4.000.000 Users. 16 on line doors. Unlimited wireless doors.	N H A E X C	637,75
RW HAMS Connected SQL. Up-to 4.000.000 users. Online features. Unlimited on line doors.	N H A C O N	1388,15
RW HAMS Connected SQL SHIP. Up-to 4.000.000 users. Online features. Unlimited on line doors. SHIP protocol inclu.	N H A C O N S H	4403,75
RW HAMS Department Operator SQL. Up-to 4.00.000 users. Online features. Unlimited on line doors.	N H A D E P	2502,10
RW HAMS Department Operator SQL SHIP. Up-to 4.000.000 users. Online features. Unlimited on line doors. SHIP protocol inclu.	N H A D E P S H	5571,30

SALTO HAMS RW software MS SQL compatible HOTEL Access Management Software for read and write systems for MS SQL Server data bases.		Gross prices
--	--	---------------------

Description	Reference	€
RW HAMS Connected for Service. Up-to 4.000.000 users. Online features. Unlimited on line doors. SHIP protocol included.	N H A C O N 4 S	1388,15
RW HAMS Connected Plus for Service. Up-to 4.000.000 users. Online features. Unlimited on line doors. Badging functionalities. SHIP protocol included.	N H A C + N 4 S	1982,10
RW HAMS Department Operator for Service. Up-to 4.000.000 users. Online features. Unlimited on line doors. Department Operator functionalities. SHIP protocol included.	N H A D E P 4 S	2502,10

SALTO Graphical mapping software Interface		Gross prices
---	--	---------------------

Description	Reference	€
SALTO Graphical Mapping Interface. To be used with SALTO software 4 service versions.	G M I 4 S	1141,90

Contactless SUPERTAG LEGIC Smart Cards		Gross prices
Description	Reference	€
Contactless Smart Card Legic 256Bytes. White. Neutral. Pack of 50 cards	P C L 0 2 5 6 B - 5 0	388,10
Contactless Smart Card Legic 1024Bytes. White. Neutral. Pack of 50 cards	P C L 0 1 K B - 5 0	517,50
Contactless Smart Card Legic 256Bytes. Salto Design, 1 colour. Pack of 50 cards	P C L 0 2 5 6 - 5 0	356,50
Contactless Smart Card Legic 1024Bytes. Salto Design, 1 colour. Pack of 50 cards	P C L 0 1 K - 5 0	485,85
Contactless Smart Construction Card Legic 256Bytes. Salto Design.	P C L 0 2 5 6 C	7,15

Contactless SUPERTAG LEGIC Keyfobs and Bracelets		Gross prices
Description	Reference	€
Contactless Smart Fob, Blue frame and white centre. 256Bytes. Pack of 10 fobs	P F L 0 2 5 6 B - 1 0	116,70
Contactless Smart bracelet. Black with white centre. 256Bytes. Pack of 10 bracelets	P B L 0 2 5 6 B - 1 0	186,85

Contactless LEGIC advant cards		
Description	Reference	€
LEGIC advant Contactless Smart cards, 4Kbytes blank. Pack of 50 cards Net Price.	P C A 0 4 K B - 5 0	147,50

Contactless LEGIC advant SAM KIT		
Description	Reference	€
LEGIC advant SAM KIT Net Price.	S A M K I T 8	500,00

Model ECADVANT



SALTO LEGIC advant SAM equipment

To Issue Customer SAM cards Includes SAM Card, LEGIC Software and LEGIC encoder **Net Price.**

Note. The price includes the SAM card. The deliver of the SAM card is subject to the sending of the SAM kit form.

Prices - Net prices		€
Description	Reference	
LEGIC advant SAM equipment	E C A D V A N T	2500,00

SALTO contactless Mifare & DESFire cards

Description	Reference	€
Contactless smart card Mifare 1KByte. SALTO design, 1 colour. Net Price. Pack of 50 cards	P C M 0 1 K - 5 0	56,65
Contactless smart card Mifare 1KByte. White neutral. Net Price. Pack of 50 cards	P C M 0 1 K B - 5 0	59,05
Contactless smart card Mifare 4KBytes. SALTO design,1 colour. Net Price. Pack of 50 cards	P C M 0 4 K - 5 0	98,40
Contactless smart card Mifare 4KBytes. White neutral. Net Price. Pack of 50 cards	P C M 0 4 K B - 5 0	101,40
Contactless smart card DESFire 4KBytes. White neutral. Net Price. Pack of 50 cards	P C D 0 4 K B - 5 0	95,40
Contactless dual smart card Mifare 1KByte & magstripe HICO, White neutral. Net Price. Pack of 50 cards	P C M 0 1 K B H - 5 0	66,80
Contactless dual smart card Mifare 1KByte & magstripe LOCO, White neutral. Net Price. Pack of 50 cards	P C M 0 1 K B L - 5 0	65,60
Contactless smart construction card Mifare. SALTO design. Net Price.	P C M 0 1 K C	1,15
Contactless smart CUSTOMIZED card Mifare. Net Price. ¹ Printing not included - consult SALTO	P C M 0 1 K C U	1,15

SALTO contactless Mifare Ultralight C cards

Description	Reference	€
Contactless smart card Mifare Ultralight C. White neutral. Net Price.	P C M U L C B	0,45

SALTO contactless Mifare silicone bracelet

Description	Reference	€
Contactless smart silicone bracelet Mifare 1KByte. Yellow. Size M Pack of 5 bracelet. Net Price.	W B M 0 1 K Y M - 5	9,85
Contactless smart silicone bracelet Mifare 1KByte. Green. Size M Pack of 5 bracelet. Net Price.	W B M 0 1 K G M - 5	9,85
Contactless smart silicone bracelet Mifare 1KByte. Blue. Size M Pack of 5 bracelet. Net Price.	W B M 0 1 K B M - 5	9,85
Contactless smart silicone bracelet Mifare 1KByte. Red. Size M Pack of 5 bracelet. Net Price.	W B M 0 1 K R M - 5	9,85
Contactless smart silicone bracelet Mifare 1KByte. Pink. Size M Pack of 5 bracelet. Net Price.	W B M 0 1 K P M - 5	9,85
Contactless smart silicone bracelet Mifare 1KByte. White. Size M Pack of 5 bracelet. Net Price.	W B M 0 1 K W M - 5	9,85

SALTO contactless Mifare & DESFire Fobs

Description	Reference	€
Contactless smart FOB Mifare 1KByte. Blue frame & white centre. SALTO logo. Pack of 10 fobs. Net Price.	P F M 0 1 K B - 1 0	29,80
Contactless smart FOB Mifare 1KByte. Red frame & white centre. SALTO logo. Pack of 10 fobs. Net Price.	P F M 0 1 K R - 1 0	29,80
Contactless smart FOB Mifare 1KByte. Green frame & white centre. SALTO logo. Pack of 10 fobs. Net Price.	P F M 0 1 K G - 1 0	29,80
Contactless smart FOB Mifare 1KByte. Yellow frame & white centre. SALTO logo. Pack of 10 fobs. Net Price.	P F M 0 1 K Y - 1 0	29,80
Contactless smart FOB Mifare 1KByte. Black frame & white centre. SALTO logo. Pack of 10 fobs. Net Price.	P F M 0 1 K N - 1 0	29,80
Contactless smart FOB Mifare 4KByte. Blue frame & white centre. SALTO logo. Pack of 10 fobs. Net Price.	P F M 0 4 K B - 1 0	56,80
Contactless smart FOB Mifare 4KByte. Red frame & white centre. SALTO logo. Pack of 10 fobs. Net Price.	P F M 0 4 K R - 1 0	56,80
Contactless smart FOB Mifare 4KByte. Green frame & white centre. SALTO logo. Pack of 10 fobs. Net Price.	P F M 0 4 K G - 1 0	56,80
Contactless smart FOB Mifare 4KByte. Yellow frame & white centre. SALTO logo. Pack of 10 fobs. Net Price.	P F M 0 4 K Y - 1 0	56,80
Contactless smart FOB Mifare 4KByte. Black frame & white centre. SALTO logo. Pack of 10 fobs. Net Price.	P F M 0 4 K N - 1 0	56,80
Contactless smart FOB DESFire 4KByte. Blue frame & white centre. SALTO logo. Pack of 10 fobs. Net Price.	P F D 0 4 K B - 1 0	34,50
Contactless smart FOB DESFire 4KByte. Red frame & white centre. SALTO logo. Pack of 10 fobs. Net Price.	P F D 0 4 K R - 1 0	34,50
Contactless smart FOB DESFire 4KByte. Green frame & white centre. SALTO logo. Pack of 10 fobs. Net Price.	P F D 0 4 K G - 1 0	34,50
Contactless smart FOB DESFire 4KByte. Yellow frame & white centre. SALTO logo. Pack of 10 fobs. Net Price.	P F D 0 4 K Y - 1 0	34,50
Contactless smart FOB DESFire 4KByte. Black frame & white centre. SALTO logo. Pack of 10 fobs. Net Price.	P F D 0 4 K N - 1 0	34,50

SALTO contactless Mifare Bracelets

Description	Reference	€
Contactless smart bracelet Mifare 1KByte. Black & white centre. Pack of 10 bracelet. Net Price.	P B M 0 1 K N - 1 0	53,70
Contactless smart bracelet Mifare 1KByte. Red & white centre. Pack of 10 bracelet. Net Price.	P B M 0 1 K R - 1 0	53,70
Contactless smart bracelet Mifare 1KByte. Green & white centre. Pack of 10 bracelet. Net Price.	P B M 0 1 K G - 1 0	53,70
Contactless smart bracelet Mifare 1KByte. Blue & white centre. Pack of 10 bracelet. Net Price.	P B M 0 1 K B - 1 0	53,70

SALTO contactless Mifare & DESFire Stickers

Description	Reference	€
Contactless smart sticker Mifare 1KByte. White. Net Price. Pack of 20 stickers	P S M 0 1 K - 2 0	27,45
Contactless smart sticker Mifare 4KByte. White. Net Price. Pack of 20 stickers	P S M 0 4 K - 2 0	56,05

SALTO ESD key card set

For remote reporting of room problems. For hospitality projects.

Description	Reference	€
SALTO ESD key card kit. Net Price.	P C M 0 1 K E S D K I T	18,15

SALTO Contactless Self Programmable Sets

For self programmable SALTO Mifare systems.

Description	Reference	€
Contactless Mifare self programmable programming card. Net Price. Includes shadow programming card	P C M P S	11,95
Contactless Mifare self programmable office mode card. Net Price.	P C M O F	9,55
Contactless Mifare self programmable user set. Net Price. Includes shadow user card	P C M 0 1 K U S	2,40
Contactless Mifare self programmable user set. Net Price. Includes user key fob and shadow user card	P F M 0 1 K U S	6,55

SALTO SAM software

For custom card issuing.

Description	Reference	€
SAM demo Kit. Includes SAM DEMO Software. Net Price. Not sold without a EC9000. Will only work with SALTO Mifare samples.	S A M D E M O 9	34,05
SAM Software Kit. Includes SAM Software, SAM card. Gross Price To order fill out the SAM REQUEST FORM	S A M K I T 9	5542,25

Issue External Carriers

Operation of issuing external carriers (not SALTO carriers). Minimum 100 carriers.

Description	Reference	€
Issue External Carriers. Net Price.	C A R D I S	1,80

(Minimum 100 pcs, or a fix cost for the value of 100 carriers job)
Such orders of less than 100 cards MUST be pre-authorized by SALTO

SALTO SAM software
For customr card issuing.

Description	Reference	€
SAM Software Kit. Includes SAM Software, SAM card. Net price To order fill out the SAM REQUEST FORM	S A M K I T H	691,75

SALTO contactless HID i-CLASS cards

Description	Reference	€
Contactless smart card HID i-CLASS 16 Kbites 16 Pages. White neutral. Net Price. Pack of 50 cards	P C H 0 0 2 - 5 0	287,50
Contactless smart card HID i-CLASS 32 Kbites 16 Pages. White neutral. Net Price. Pack of 50 cards	P C H 0 0 4 - 5 0	287,50
Contactless Construction card HID i-CLASS. Net Price.	P C H 0 0 2 C	5,75

Terms and conditions

Valid as from July 2020

Prices are ex. VAT. Prices are Ex-Works Oiartzun.

Standard delivery date approx 4 weeks. The standard delivery time is an estimate only and cannot be guaranteed by SALTO.

The information contained in this price list can be modified by SALTO without prior notice.

If an order is cancelled within 2 weeks of shipment date, SALTO will charge 30% of the order cost.

SALTO is not responsible for any technical or printing errors contained in this price list.

This price list does not form a contract between SALTO and any third parties.

