

# Installation Solution Simulator

## Q-series

ver. Oct. 2022

Ø95.4mm (3.75") / 2 holes

QND-6072R1    QND-6082R    QND-6082R1    QND-7082R    QND-8080R

Ø120.6mm (4.75") / 3 holes

QNV-6070R    QNV-7080R

Ø106mm (4.17") / 2 holes

QNV-6010R    QNV-6020R    QNV-6030R    QNV-7010R    QNV-7020R    QNV-7030R

Ø95.3mm (3.752") / 2 holes

QND-6012R1    QND-6022R1    QND-6032R1    QND-7012R    QND-7022R    QND-7032R    QND-8010R    QND-8020R    QND-8030R

Ø109mm (4.29") / 2 holes

QNE-8011R    QNE-8021R

Ø127.8mm (5.03") / 3 holes

QNE-6080RVW    QNE-7080RVW

Ø127.8mm (5.03") / 3 holes

QNE-6080RV    QNE-7080RV

Ø95.3mm (3.752") / 2 holes

QND-6010R    QND-6020R    QND-6030R    QND-7010R    QND-7020R    QND-7030R

Ø95.4mm (3.75") / 2 holes

QND-6070R    QND-7080R

Ø73mm (2.87") / 3 Shafts

QNP-6250H    QNP-6320H

Ø120.2mm (4.73") / 4 holes

QNP-6250    QNP-6320

Ø120.2mm (4.73") / 4 holes

QNP-6230

1-1/2 inch PF TAP

QNP-6230H    QNP-6230RH

Ø83.5mm (3.29") / 2 holes

QND-6011    QND-6021    QND-8011    QND-8021

1/4"-20 UNC TAP / 2 holes

QNB-6002    QNB-8002

Ø120.6mm (4.75") / 3 holes

QNV-6072R1    QNV-6082R    QNV-6082R1    QNV-7082R    QNV-8080R

Ø65.5mm (2.58") / 3 holes

QNO-6010R    QNO-6012R1    QNO-6020R    QNO-6022R1    QNO-6030R    QNO-6032R1    QNO-6070R    QNO-6072R1    QNO-6082R    QNO-6082R1    QNO-7010R

Ø106mm (4.17") / 2 holes

QNV-6012R1    QNV-6022R1    QNV-6032R1    QNV-7012R    QNV-7022R    QNV-7032R    QNV-8010R    QNV-8020R    QNV-8030R

Ø65.5mm (2.58") / 3 holes

QNO-7012R    QNO-7020R    QNO-7022R    QNO-7030R    QNO-7032R    QNO-7080R    QNO-7082R    QNO-8010R    QNO-8020R    QNO-8030R    Ø70mm (2.76") / 3 holes QNO-8080R

Full Lineup of Q-series Camera

Camera	Full Lineup of Acc.	Ceiling	Wall	Pole	Corner	Parapet
Dome						
QND - 6072R1 / 6082R(1) / 7082R / 8080R	●	●	●	●	●	●
QND - 6012R1 / 6022R1 / 6032R1 / 7012R / 7022R / 7032R / 8010R / 8020R / 8030R	●	●	●	●	●	●
QND - 6010R / 6020R / 6030R / 7010R / 7020R / 7030R (ivory)	●	●	●	●	●	●
QND - 6070R / 7080R (ivory)	●	●	●	●	●	●
Vandal						
QND - 6011 / 6021 / 8011 / 8021	●	●	●	●	●	●
QNV - 6072R1 / 6082R(1) / 7082R / 8080R	●	●	●	●	●	●
QNV - 6012R1 / 6022R1 / 6032R1 / 7012R / 7022R / 7032R / 8010R / 8020R / 8030R	●	●	●	●	●	●
QNV - 6070R / 7080R (ivory)	●	●	●	●	●	●
QNV - 6010R / 6020R / 6030R / 7010R / 7020R / 7030R (ivory)	●	●	●	●	●	●
Flat Dome						
QNE - 8011R / 8021R	●	●	●	●	●	●
QNE - 6080RVW / 7080RVW	●	●	●	●	●	●
QNE - 6080RV / 7080RV (ivory)	●	●	●	●	●	●
PTZ						
QNP - 6250H / 6320H	●	●	●	●	●	●
QNP - 6250 / 6320	●	●	●	●	●	●
QNP - 6230 (ivory)	●	●	●	●	●	●
QNP - 6230H / 6230RH (ivory)	●	●	●	●	●	●
Box						
QNB - 6002 / 8002	●					
Bullet						
QNO - 6010R / 6012R1 / 6020R / 6022R1 / 6030R / 6032R1 / 6070R / 6072R1 / 6082R / 6082R1 / 7010R / 7012R / 7020R / 7022R / 7030R / 7032R / 7080R / 7082R / 8010R / 8020R / 8030R / 8080R	●			●		

Ø95.4mm (3.75") / 2 holes

QND-6072R1



Ø119.8 x 98.8mm (Ø4.72 x 3.89")  
320g (0.705 lb)

QND-6082R



Ø119.8 x 98.8mm (Ø4.72 x 3.89")  
320g (0.705 lb)

QND-6082R1



Ø119.8 x 98.8mm (Ø4.72 x 3.89")  
320g (0.705 lb)

QND-7082R



Ø119.8 x 98.8mm (Ø4.72 x 3.89")  
320g (0.705 lb)

QND-8080R



Ø120.3x102.0mm (Ø4.74x4.02")  
430g (0.95 lb)

Camera spec.

**Full Lineup of Acc.**

Ceiling













Wall

Pole

Corner

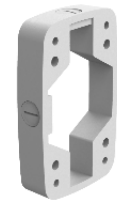
Parapet

QND - 6072R1 / 6082R(1) / 7082R / 8080R

				
<p><b>Hanging Mount</b> SBP-122HMW</p>	<p><b>Ceiling Mount</b> SBP-300CMW</p>	<p><b>In-ceiling Housing</b> SHD-1198FW</p>	<p><b>In-ceiling Housing</b> SHD-1408FPW</p>	<p><b>Wall Mount</b> SBP-300WMW1</p>
				
<p><b>Wall Mount</b> SBP-300WMW</p>	<p><b>Wall Mount</b> SBP-390WMW2</p>	<p><b>Wall Mount</b> SBP-120WMW</p>	<p><b>Wall Mount Base</b> SBP-300BW</p>	<p><b>Pole Mount</b> SBP-300PMW1</p>
				
<p><b>Corner Mount</b> SBP-300KMW1</p>	<p><b>Parapet Mount</b> SBP-300LMW</p>	<p><b>Installation Box</b> SBP-300NBW</p>		

QND - 6072R1 / 6082R(1) / 7082R / 8080R



Ceiling Mount



SBP-300CMW



Hanging Mount



SBP-122HMW



In-ceiling Housing



SHD-1198FW

or

Plenum



SHD-1408FPW

QND - 6072R1 / 6082R(1) / 7082R / 8080R



Wall Mount



SBP-120MMW

Wall Mount

Option



Installation Box  
SBP-300NBW



SBP-390MMW2



Option



Installation Box  
SBP-300NBW

Option

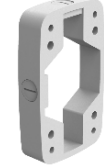

Wall Mount Base  
SBP-300BW



SBP-300MMW1



SBP-300MMW



Hanging Mount



SBP-122HMW

QND - 6072R1 / 6082R(1) / 7082R / 8080R



**Pole Mount**



SBP-300PMW1



**Option**



Installation Box  
SBP-300NBW



SBP-390MMW2

or



SBP-300MMW1

or



SBP-300MMW



**Hanging Mount**



SBP-122HMW



QND - 6072R1 / 6082R(1) / 7082R / 8080R

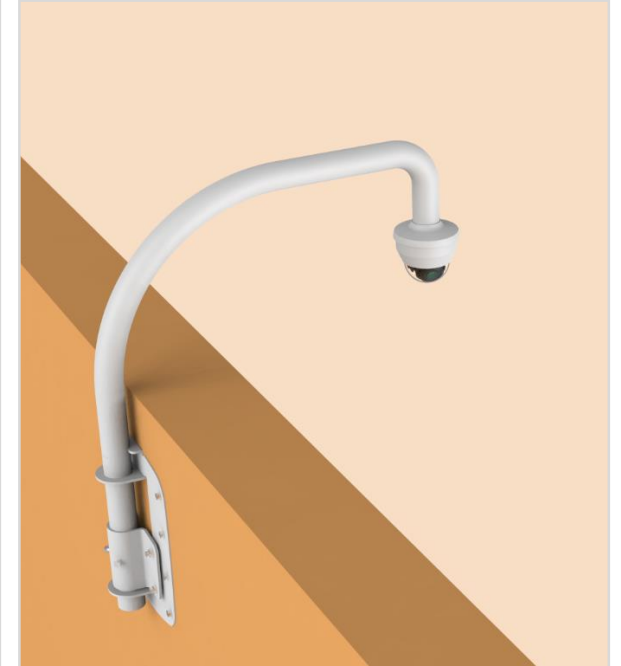

Corner Mount



SBP-300KMW1



Option



Installation Box  
SBP-300NBW



Wall Mount



SBP-390WMW2

or



SBP-300WMW1

or



SBP-300WMW



Hanging Mount



SBP-122HMW

Parapet Mount



SBP-300LMW











Hanging Mount



SBP-122HMW

Ø95.3mm (3.752") / 2 holes

QND-6012R1	QND-6022R1	QND-6032R1	QND-7012R	QND-7022R	QND-7032R	QND-8010R	QND-8020R	QND-8030R
								
Ø110.6x86.0mm (Ø4.33x3.39") 255g (0.562 lb)	Ø110.6x86.0mm (Ø4.33x3.39") 255g (0.562 lb)	Ø110.6x86.0mm (Ø4.33x3.39") 255g (0.562 lb)	Ø110.6x86.0mm (Ø4.33x3.39") 255g (0.562 lb)	Ø110.6x86.0mm (Ø4.33x3.39") 255g (0.562 lb)	Ø110.6x86.0mm (Ø4.33x3.39") 255g (0.562 lb)	Ø110.6x89.5mm (Ø4.35x3.52") 360g(0.79 lb)	Ø110.6x89.5mm (Ø4.35x3.52") 360g(0.79 lb)	Ø110.6x89.5mm (Ø4.35x3.52") 360g(0.79 lb)

Camera spec.

**Full Lineup of Acc.**

Ceiling













Wall

Pole

Corner

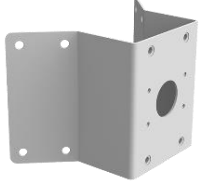
Parapet

QND - 6012R1 / 6022R1 / 6032R1 / 7012R / 7022R / 7032R / 8010R / 8020R / 8030R

				
<p><b>Hanging Mount</b> SBP-300HMW7</p>	<p><b>ceiling Mount</b> SBP-300CMW</p>	<p><b>In-ceiling Housing</b> SHD-1128FPW</p>	<p><b>Wall Mount</b> SBP-300WMW1</p>	<p><b>Wall Mount</b> SBP-300WMW</p>
				
<p><b>Wall Mount</b> SBP-390WMW2</p>	<p><b>Wall Mount</b> SBP-120WMW</p>	<p><b>Wall Mount Base</b> SBP-300BW</p>	<p><b>Pole Mount</b> SBP-300PMW1</p>	<p><b>Corner Mount</b> SBP-300KMW1</p>
				
<p><b>Parapet Mount</b> SBP-300LMW</p>	<p><b>Installation Box</b> SBP-300NBW</p>	<p><b>Black Dome Cover</b> SPG-IND12B</p>		

QND - 6012R1 / 6022R1 / 6032R1 / 7012R / 7022R / 7032R / 8010R / 8020R / 8030R



Ceiling Mount



SBP-300CMW



Hanging Mount



SBP-300HMW7



In-ceiling Housing

Plenum



QND - 6012R1 / 6022R1 / 6032R1 / 7012R / 7022R / 7032R / 8010R / 8020R / 8030R



Wall Mount



SBP-120MMW

Wall Mount

Option



Installation Box  
SBP-300NBW



SBP-390MMW2



Option



Installation Box  
SBP-300NBW



Wall Mount Base  
SBP-300BW



SBP-300MMW1



SBP-300MMW



SBP-300HMW7

Hanging Mount

QND - 6012R1 / 6022R1 / 6032R1 / 7012R / 7022R / 7032R / 8010R / 8020R / 8030R



Pole Mount



SBP-300PMW1



Option



Installation Box  
SBP-300NBW



SBP-390MMW2

or



SBP-300MMW1

or



SBP-300MMW



Hanging Mount



SBP-300HMW7

QND - 6012R1 / 6022R1 / 6032R1 / 7012R / 7022R / 7032R / 8010R / 8020R / 8030R

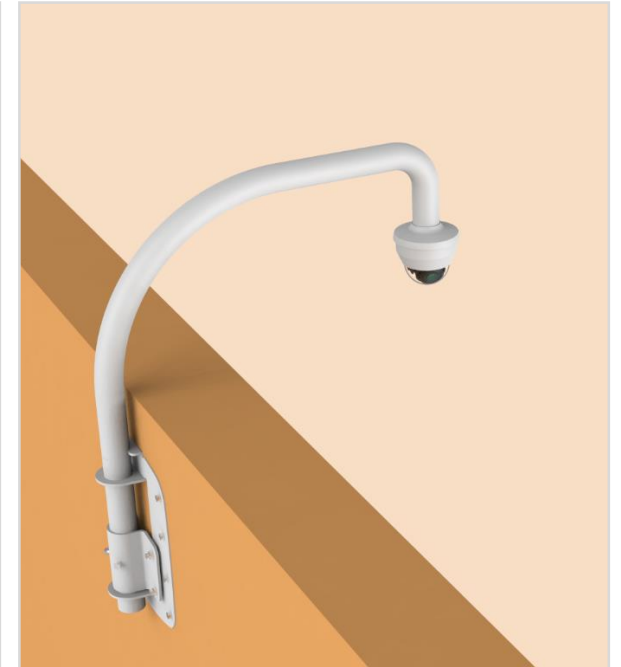

**Corner Mount**

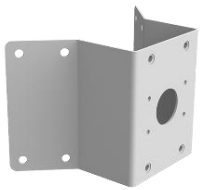

SBP-300KMW1



Option



Installation Box  
SBP-300NBW



SBP-390MMW2

or



SBP-300MMW1

or



SBP-300MMW



**Hanging Mount**



SBP-300HMW7

**Parapet Mount**



SBP-300LMW



**Hanging Mount**



SBP-300HMW7

Ø106mm (4.17") / 2 holes

QND-6010R

QND-6020R

QND-6030R

QND-7010R

QND-7020R

QND-7030R



Ø110.6x86.0mm(Ø4.33x3.39")  
290g(0.64 lb)

Ø110.6x86.0mm(Ø4.33x3.39")  
290g(0.64 lb)

Ø110.6x86.0mm(Ø4.33x3.39")  
290g(0.64 lb)

Ø110.6x86.0mm(Ø4.33x3.39")  
290g(0.64 lb)

Ø110.6x86.0mm(Ø4.33x3.39")  
290g(0.64 lb)

Ø110.6x86.0mm(Ø4.33x3.39")  
290g(0.64 lb)



Camera spec.

**Full Lineup of Acc.**

Ceiling















Wall1 / Wall2

Pole

Corner

Parapet

QND - 6010R / 6020R / 6030R / 7010R / 7020R / 7030R (ivory)

				
<p><b>Back Plate</b> SBD-110GP</p>	<p><b>Hanging Mount</b> SBP-300HM7</p>	<p><b>Ceiling Mount</b> SBP-300CM</p>	<p><b>In-ceiling Housing (White)</b> SHD-1128FPW</p>	<p><b>Wall Mount</b> SBP-300WM1</p>
				
<p><b>Wall Mount</b> SBP-300WM</p>	<p><b>Wall Mount</b> SBP-390WM2</p>	<p><b>Wall Mount</b> SBP-120WM</p>	<p><b>Wall Mount Base</b> SBP-300B</p>	<p><b>Pole Mount</b> SBP-300PM1</p>
				
<p><b>Corner Mount</b> SBP-300KM1</p>	<p><b>Parapet Mount</b> SBP-300LM</p>	<p><b>Smoke Dome Cover</b> SPB-IND12</p>	<p><b>Black Dome Cover</b> SPG-IND12B</p>	

QND - 6010R / 6020R / 6030R / 7010R / 7020R / 7030R (ivory)



Mount Plate



SBD-110GP

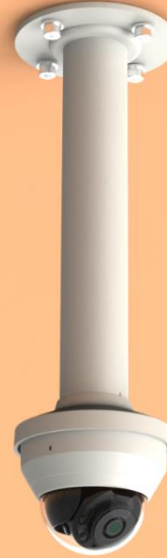

Ceiling Mount



SBP-300CM



Hanging Mount



SBP-300HM7



In-ceiling Housing

Plenum



SHD-1128FPW

QND - 6010R / 6020R / 6030R / 7010R / 7020R / 7030R (ivory)



Mount Plate



SBD-110GP



Wall Mount



SBP-120WM

QND - 6010R / 6020R / 6030R / 7010R / 7020R / 7030R (ivory)



Wall Mount

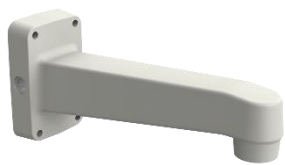

SBP-390WM2

or

Option

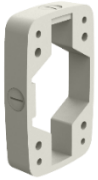

Wall Mount Base  
SBP-300B

+



SBP-300WM1

or



SBP-300WM

+

Hanging Mount



SBP-300HM7

QND - 6010R / 6020R / 6030R / 7010R / 7020R / 7030R (ivory)



**Pole Mount**



SBP-300PM1



**Wall Mount**

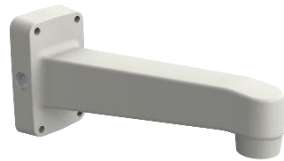

SBP-390WM2

or



SBP-300WM1

or



SBP-300WM



**Hanging Mount**



SBP-300HM7

QND - 6010R / 6020R / 6030R / 7010R / 7020R / 7030R (ivory)

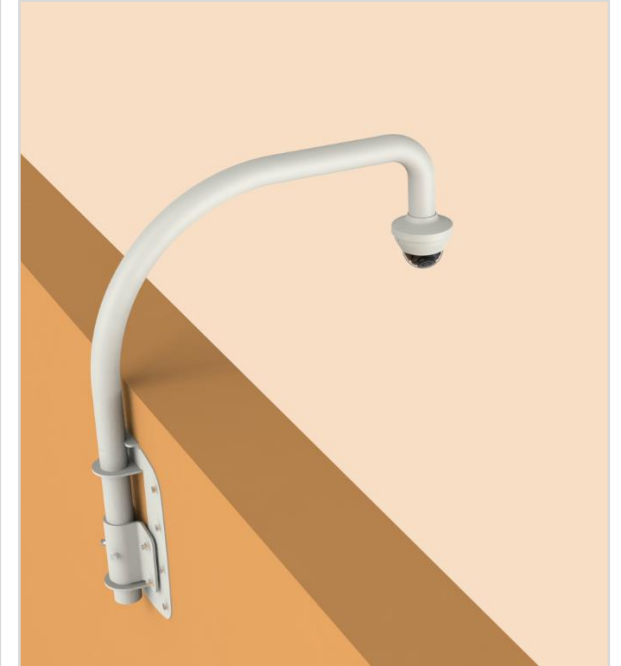

Corner Mount



SBP-300KM1



Wall Mount

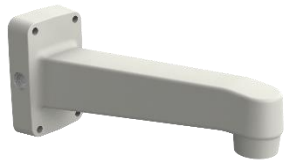

SBP-390WM2

or



SBP-300WM1

or



SBP-300WM



Hanging Mount



SBP-300HM7



Parapet Mount



SBP-300LM

Hanging Mount



SBP-300HM7

Ø95.4mm (3.75") / 2 holes

QND-6070R



Ø119.8 x 98.8mm (Ø4.72 x 3.89")  
325g(0.72 lb)

QND-7080R



Ø119.8 x 98.8mm (Ø4.72 x 3.89")  
355g(0.78 lb)

Camera spec.

**Full Lineup of Acc.**

Ceiling

















Wall1 / Wall2

Pole

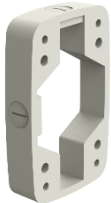
Corner

Parapet

QND - 6070R / 7080R (ivory)

					
<b>Back Plate</b> SBD-120GP	<b>Hanging Mount</b> SBP-122HM	<b>In-ceiling Housing</b> SHD-3000F2	<b>In-ceiling Housing</b> SHD-1198FW	<b>In-ceiling Housing</b> SHD-1408FPW	<b>Ceiling Mount</b> SBP-300CM
					
<b>Wall Mount</b> SBP-300WM1	<b>Wall Mount</b> SBP-300WM	<b>Wall Mount</b> SBP-390WM2	<b>Wall Mount</b> SBP-120WM	<b>Wall Mount Base</b> SBP-300B	<b>Pole Mount</b> SBP-300PM1
					
<b>Corner Mount</b> SBP-300KM1	<b>Parapet Mount</b> SBP-300LM	<b>Smoke Dome Cover</b> SPB-IND72	<b>Black Dome Cover</b> SPG-IND72B		



QND - 6070R / 7080R (ivory)



Mount Plate



SBD-120GP



Ceiling Mount



SBP-300CM



Hanging Mount



SBP-122HM



In-ceiling Housing



SHD-3000F2

or



SHD-1198FW

or



SHD-1408FPW

Plenum

QND - 6070R / 7080R (ivory)



Mount Plate



SBD-120GP



Wall Mount



SBP-120WM

QND - 6070R / 7080R (ivory)



Wall Mount

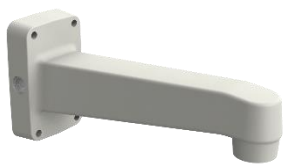

SBP-390WM2

or

Option



Wall Mount Base  
SBP-300B

+



SBP-300WM1

or



SBP-300WM

+

Hanging Mount



SBP-122HM

QND - 6070R / 7080R (ivory)



Pole Mount



SBP-300PM1



Wall Mount

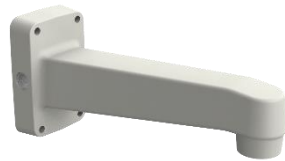

SBP-390WM2

or



SBP-300WM1

or



SBP-300WM



Hanging Mount



SBP-122HM

Camera spec.

Full Lineup of Acc.

Ceiling

Wall1 / Wall2

Pole

Corner

Parapet

QND - 6070R / 7080R (ivory)

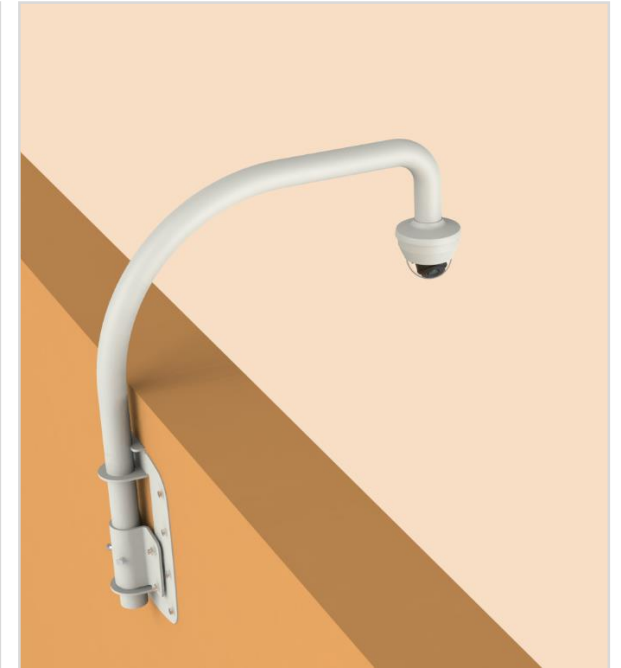

Corner Mount



SBP-300KM1



Wall Mount

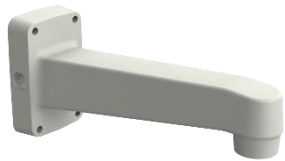

SBP-390WM2

or



SBP-300WM1

or



SBP-300WM



Hanging Mount



SBP-122HM



Parapet Mount



SBP-300LM

Hanging Mount



SBP-122HM

Ø83.5mm (3.29") / 2 holes

QND-6011



Ø99.0x56.0mm(Ø3.9x2.2")  
145g(0.32 lb)

QND-6021



Ø99.0x56.0mm(Ø3.9x2.2")  
145g(0.32 lb)

QND-8011



Ø99.0x56.0mm(Ø3.9x2.2")  
165g(0.36 lb)

QND-8021



Ø99.0x56.0mm(Ø3.9x2.2")  
165g(0.36 lb)

Camera spec.

**Full Lineup of Acc.**

Ceiling













Wall

Pole

Corner

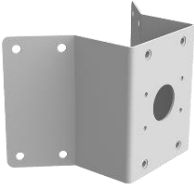
Parapet

QND - 6011 / 6021 / 8011 / 8021

				
<p><b>Hanging Mount</b> SBP-099HMW</p>	<p><b>Ceiling Mount</b> SBP-300CMW</p>	<p><b>In-ceiling Housing</b> SHD-1128FPW</p>	<p><b>Wall Mount</b> SBP-300WMW1</p>	<p><b>Wall Mount</b> SBP-300WMW</p>
				
<p><b>Wall Mount</b> SBP-390WMW2</p>	<p><b>Wall Mount</b> SBP-120WMW</p>	<p><b>Wall Mount Base</b> SBP-300BW</p>	<p><b>Pole Mount</b> SBP-300PMW1</p>	<p><b>Corner Mount</b> SBP-300KMW1</p>
				
<p><b>Parapet Mount</b> SBP-300LMW</p>	<p><b>Installation Box</b> SBP-300NBW</p>	<p><b>Black Dome Cover</b> SPG-IND16B</p>		

QND - 6011 / 6021 / 8011 / 8021

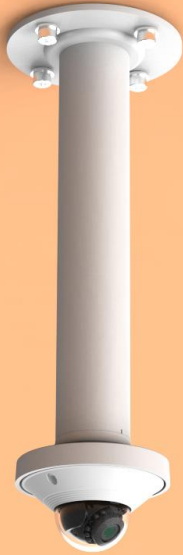

Ceiling Mount



SBP-300CMW



Hanging Mount



SBP-099HMW



In-ceiling Housing

Plenum



SHD-1128FPW



QND - 6011 / 6021 / 8011 / 8021



Wall Mount



SBP-120MMW



Wall Mount

Hanging Mount

Option



Installation Box SBP-300NBW



SBP-390MMW2



Installation Box SBP-300NBW

Option

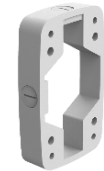

Wall Mount Base SBP-300BW



SBP-300MMW1



SBP-300MMW



SBP-099HMW

QND - 6011 / 6021 / 8011 / 8021



Pole Mount



SBP-300PMW1



Option



Installation Box  
SBP-300NBW



SBP-390MMW2

or



SBP-300MMW1

or



SBP-300MMW



Hanging Mount



SBP-099HMW

QND - 6011 / 6021 / 8011 / 8021

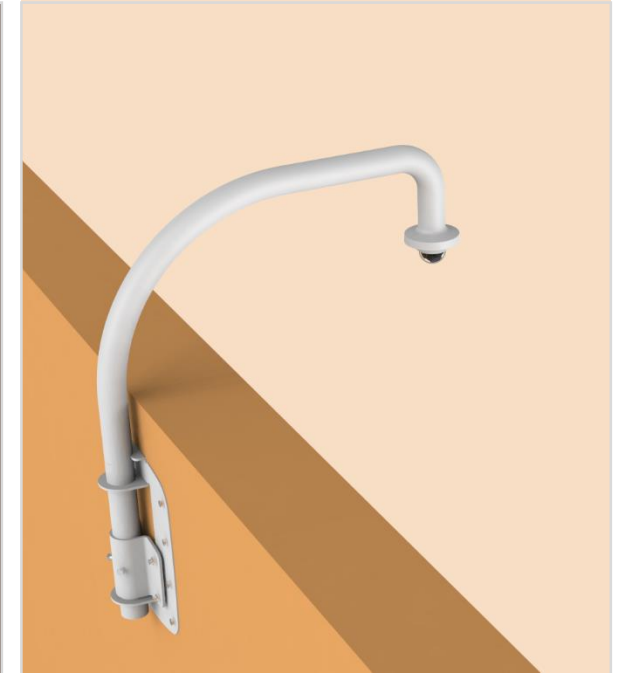

**Corner Mount**

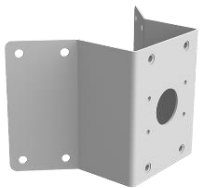

SBP-300KMW1



Option



Installation Box  
SBP-300NBW



**Wall Mount**



SBP-390WMW2

or



SBP-300WMW1

or



SBP-300WMW



**Hanging Mount**



SBP-099HMW



**Parapet Mount**



SBP-300LMW

**Hanging Mount**



SBP-099HMW

Ø120.6mm (4.75") / 3 holes

QNV-6072R1

QNV-6082R

QNV-6082R1

QNV-7082R

QNV-8080R



Ø137.0 x 106.1mm (Ø5.39 x 4.18")  
710g(1.57 lb)

Ø137.0 x 106.1mm (Ø5.39 x 4.18")  
710g(1.57 lb)

Ø137.0 x 106.1mm (Ø5.39 x 4.18")  
710g(1.57 lb)

Ø137.0 x 106.1mm (Ø5.39 x 4.18")  
710g(1.57 lb)

Ø137.0x106.1mm(Ø5.39x4.18")  
700g(1.54 lb)

Camera spec.

**Full Lineup of Acc.**

Ceiling













Wall1 / Wall2

Pole

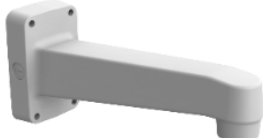
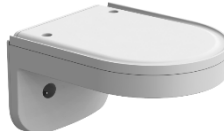
Corner

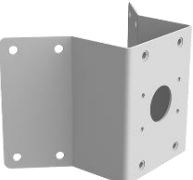
Parapet

QNV - 6072R1 / 6082R(1) / 7082R / 8080R

				
<p><b>Hanging Mount</b> SBP-301HMM2</p>	<p><b>Ceiling Mount</b> SBP-300CMW</p>	<p><b>In-ceiling Housing</b> SHD-1408FW</p>	<p><b>In-ceiling Housing</b> SHD-1408FPW</p>	<p><b>Wall Mount</b> SBP-300WMW1</p>
				
<p><b>Wall Mount</b> SBP-300WMW</p>	<p><b>Wall Mount</b> SBP-390WMW2</p>	<p><b>Wall Mount</b> SBP-137WMW1</p>	<p><b>Wall Mount Base</b> SBP-300BW</p>	<p><b>Pole Mount</b> SBP-300PMW1</p>
				
<p><b>Corner Mount</b> SBP-300KMW1</p>	<p><b>Parapet Mount</b> SBP-300LMW</p>	<p><b>Installation Box</b> SBP-300NBW</p>	<p><b>Back Box</b> SBV-136BW</p>	<p><b>Smoke Dome Cover</b> SPB-VAW72</p>

QNV - 6072R1 / 6082R(1) / 7082R / 8080R



Back Box



SBV-136BW



Ceiling Mount



SBP-300CMW



Hanging Mount



SBP-301HMW2



In-ceiling Housing



SHD-1408FW

or



SHD-1408FPW

QNV - 6072R1 / 6082R(1) / 7082R / 8080R



Back Box



SBV-136BW



Wall Mount



SBV-137WMW1

QNV - 6072R1 / 6082R(1) / 7082R / 8080R



Wall Mount

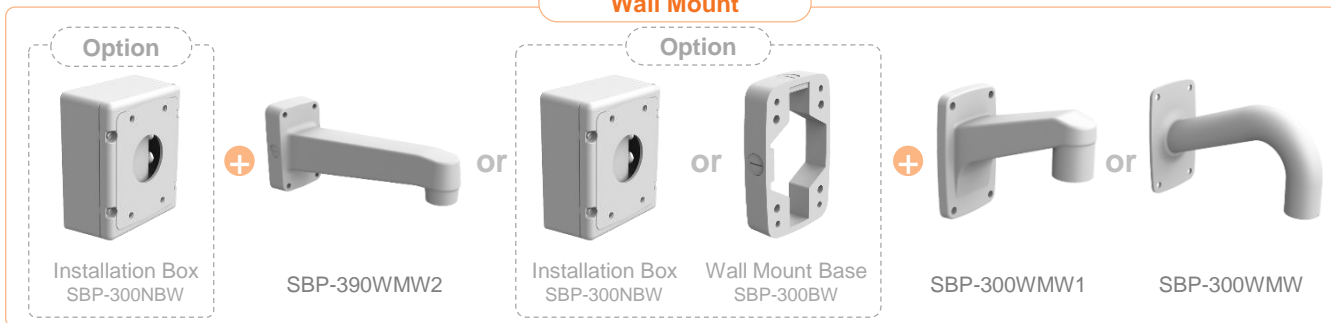

Hanging Mount





QNV - 6072R1 / 6082R(1) / 7082R / 8080R



Pole Mount



SBP-300PMW1



Wall Mount

Option



Installation Box  
SBP-300NBW



SBP-390WMW2

or



SBP-300WMW1

or



SBP-300WMW



Hanging Mount



SBP-301HMW2

QNV - 6072R1 / 6082R(1) / 7082R / 8080R

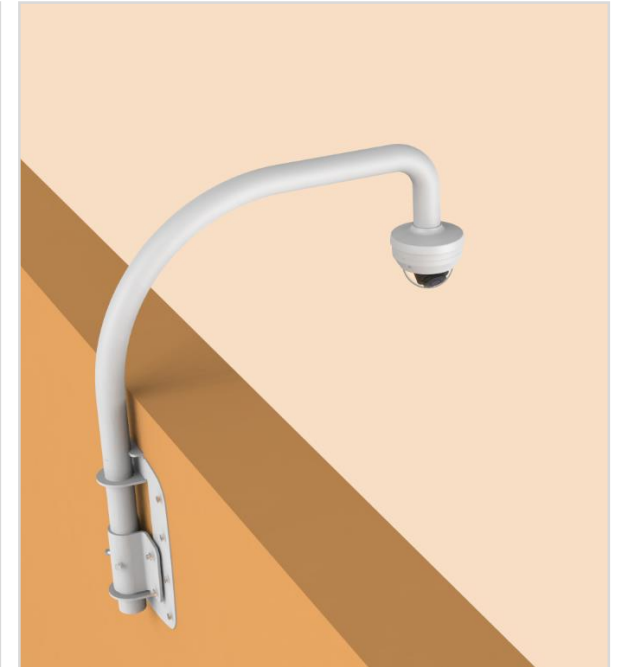

Corner Mount

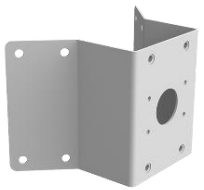

SBP-300KMW1



Option



Installation Box  
SBP-300NBW



Wall Mount



SBP-390WMW2

or



SBP-300WMW1

or



SBP-300WMW



Hanging Mount



SBP-301HMW2



Parapet Mount



SBP-300LMW

Hanging Mount



SBP-301HMW2

Ø106mm (4.17") / 2 holes

QNV-6012R1      QNV-6022R1      QNV-6032R1      QNV-7012R      QNV-7022R      QNV-7032R      QNV-8010R      QNV-8020R      QNV-8030R



Ø120.3x91.7mm  
(Ø4.74x3.61")  
510g(1.12 lb)

Ø120.3x91.7mm  
(Ø4.74x3.61")  
510g(1.12 lb)

Ø120.3x91.7mm  
(Ø4.74x3.61")  
510g(1.12 lb)

Ø120.3x91.7mm  
(Ø4.74x3.61")  
510g(1.12 lb)

Ø120.3x91.7mm  
(Ø4.74x3.61")  
510g(1.12 lb)

Ø120.3x91.7mm  
(Ø4.74x3.61")  
510g(1.12 lb)

Ø120.3x91.7mm  
(Ø4.74x3.61")  
510g(1.12 lb)

Ø120.3x91.7mm  
(Ø4.74x3.61")  
510g(1.12 lb)

Ø120.3x91.7mm  
(Ø4.74x3.61")  
510g(1.12 lb)

Camera spec.

**Full Lineup of Acc.**

Ceiling















Wall1 / Wall2

Pole

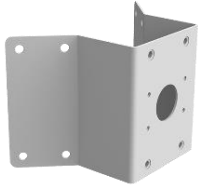
Corner

Parapet

QNV - 6012R1 / 6022R1 / 6032R1 / 7012R / 7022R / 7032R / 8010R / 8020R / 8030R

				
<p><b>Back Box</b> SBP-122HMW</p>	<p><b>Ceiling Mount</b> SBP-300CMW</p>	<p><b>In-ceiling Housing</b> SHD-1408FPW</p>	<p><b>Wall Mount</b> SBP-300WMW1</p>	<p><b>Wall Mount</b> SBP-300WMW</p>
				
<p><b>Wall Mount</b> SBP-390WMW2</p>	<p><b>Wall Mount</b> SBP-137WMW1</p>	<p><b>Wall Mount Base</b> SBP-300BW</p>	<p><b>Pole Mount</b> SBP-300PMW1</p>	<p><b>Corner Mount</b> SBP-300KMW1</p>
				
<p><b>Parapet Mount</b> SBP-300LMW</p>	<p><b>Installation Box</b> SBP-300NBW</p>	<p><b>Back Box</b> SBV-120GW</p>	<p><b>Weather Cap</b> SBV-120WCW</p>	<p><b>Smoke Dome Cover</b> SPB-VAW12</p>

QNV - 6012R1 / 6022R1 / 6032R1 / 7012R / 7022R / 7032R / 8010R / 8020R / 8030R



Back Box



SBV-120GW



Ceiling Mount



SBP-300CMW



Hanging Mount



SBP-122HMW



In-ceiling Housing

Plenum



SHD-1408FPW

QNV - 6012R1 / 6022R1 / 6032R1 / 7012R / 7022R / 7032R / 8010R / 8020R / 8030R



Back Box



SBV-120GW



Weather Cap



SBV-120WCW



Wall Mount



SBP-137MMW1

QNV - 6012R1 / 6022R1 / 6032R1 / 7012R / 7022R / 7032R / 8010R / 8020R / 8030R



**Wall Mount**

**Option**

Installation Box SBP-300NBW + SBP-390WMW2 or Installation Box SBP-300NBW or Wall Mount Base SBP-300BW + SBP-300WMW1 or SBP-300MMW

**Hanging Mount**

+ SBP-122HMW

QNV - 6012R1 / 6022R1 / 6032R1 / 7012R / 7022R / 7032R / 8010R / 8020R / 8030R



Pole Mount



SBP-300PMW1



Option



Installation Box  
SBP-300NBW



SBP-390MMW2

or



SBP-300MMW1

or



SBP-300MMW



Hanging Mount



SBP-122HMW



Camera spec.

Full Lineup of Acc.

Ceiling

Wall1 / Wall2

Pole

**Corner**

**Parapet**

QNV - 6012R1 / 6022R1 / 6032R1 / 7012R / 7022R / 7032R / 8010R / 8020R / 8030R

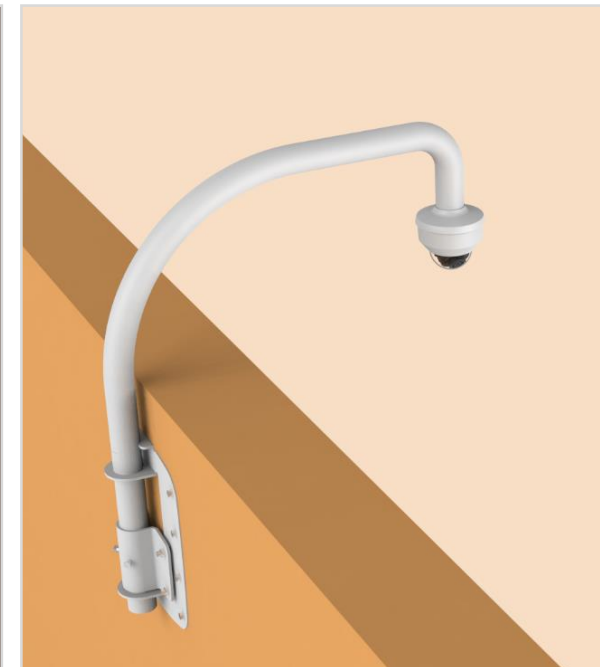

**Corner Mount**

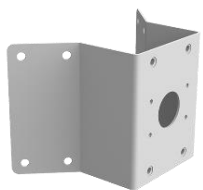

SBP-300KMW1



Option



Installation Box  
SBP-300NBW



**Wall Mount**



SBP-390WMW2

or



SBP-300MMW1

or



SBP-300MMW



**Hanging Mount**



SBP-122HMW



**Parapet Mount**



SBP-300LMW

**Hanging Mount**



SBP-122HMW

Ø120.6mm (4.75") / 3 holes

QNV-6070R



Ø137.0 x 106.1mm (Ø5.39 x 4.18")  
660g(1.46 lb)

QNV-7080R



Ø137.0 x 106.1mm (Ø5.39 x 4.18")  
680g(1.50 lb)

Camera spec.

**Full Lineup of Acc.**

Ceiling















Wall1 / Wall2

Pole

Corner

Parapet

QNV - 6070R / 7080R (ivory)

				
<p><b>Hanging Mount</b> SBP-301HM5</p>	<p><b>Ceiling Mount</b> SBP-300CM</p>	<p><b>In-ceiling Housing</b> SHD-1408FPW</p>	<p><b>In-ceiling Housing</b> SHD-1408FW</p>	<p><b>Wall Mount</b> SBP-300WM1</p>
				
<p><b>Wall Mount</b> SBP-300WM</p>	<p><b>Wall Mount</b> SBP-390WM2</p>	<p><b>Wall Mount</b> SBP-137WM1</p>	<p><b>Wall Mount Base</b> SBP-300B</p>	<p><b>Pole Mount</b> SBP-300PM1</p>
				
<p><b>Corner Mount</b> SBP-300KM1</p>	<p><b>Parapet Mount</b> SBP-300LM</p>	<p><b>Back Box</b> SBP-136B</p>	<p><b>Smoke Dome Cover</b> SBP-VAN72</p>	

QNV - 6070R / 7080R (ivory)



Back Box



SBP-136B



Ceiling Mount



SBP-300CMW



Hanging Mount



SBP-301HM5



In-ceiling Housing

Plenum



SHD-1408FPW

or

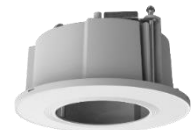

SHD-1408FW

QNV - 6070R / 7080R (ivory)



Back Box



SBV-136B



Wall Mount



SBV-137WM1

QNV - 6070R / 7080R (ivory)



Wall Mount

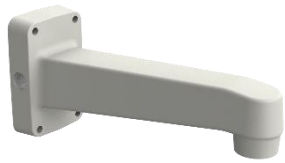

SBP-390WM2

or

Option

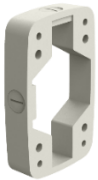

Wall Mount Base  
SBP-300B

+



SBP-300WM1

or



SBP-300WM

+

Hanging Mount



SBP-301HM5

QNV - 6070R / 7080R (ivory)



Pole Mount



SBP-300PM1



Wall Mount

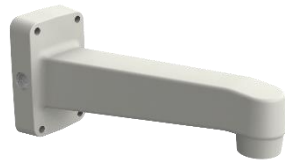

SBP-390WM2

or



SBP-300WM1

or



SBP-300WM



Hanging Mount



SBP-301HM5

QNV - 6070R / 7080R (ivory)

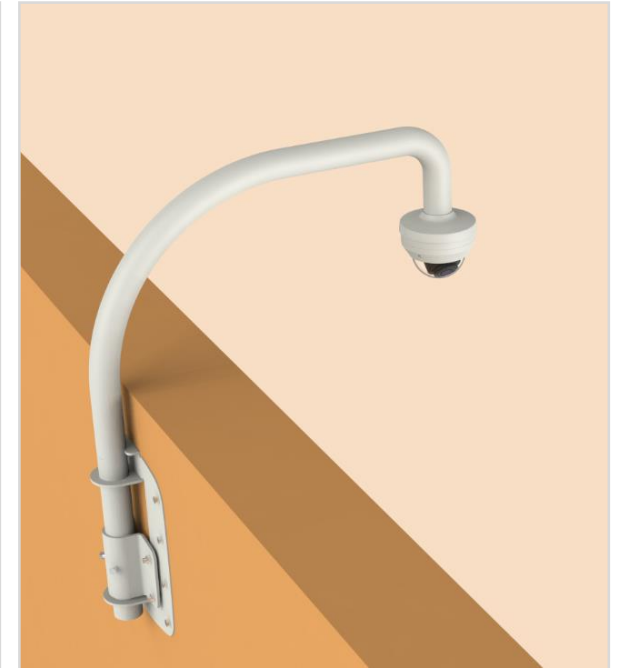

Corner Mount



SBP-300KM1



Wall Mount

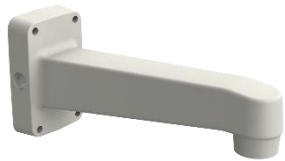

SBP-390WM2

or



SBP-300WM1

or



SBP-300WM



Hanging Mount



SBP-301HM5

Parapet Mount



SBP-300LM



Hanging Mount



SBP-301HM5



**Camera spec.**

Full Lineup of Acc.

Ceiling

Wall1 / Wall2

Pole

Corner

Parapet

Ø106mm (4.17") / 2 holes

QNV-6010R

QNV-6020R

QNV-6030R

QNV-7010R

QNV-7020R

QNV-7030R



Ø120.3x91.7mm(Ø4.74x3.61")  
490g(1.08 lb)

Ø120.3x91.7mm(Ø4.74x3.61")  
490g(1.08 lb)

Ø120.3x91.7mm(Ø4.74x3.61")  
490g(1.08 lb)

Ø120.3x91.7mm(Ø4.74x3.61")  
490g(1.08 lb)

Ø120.3x91.7mm(Ø4.74x3.61")  
490g(1.08 lb)

Ø120.3x91.7mm(Ø4.74x3.61")  
490g(1.08 lb)

Camera spec.

**Full Lineup of Acc.**

Ceiling









Wall1 / Wall2

Pole

Corner

Parapet

QNV - 6010R / 6020R / 6030R / 7010R / 7020R / 7030R (ivory)

				
<p><b>Hanging Mount</b> SBP-122HM</p>	<p><b>Ceiling Mount</b> SBP-300CM</p>	<p><b>Wall Mount</b> SBP-300WM1</p>	<p><b>Wall Mount</b> SBP-300WM</p>	<p><b>Wall Mount</b> SBP-390WM2</p>
				
<p><b>Wall Mount</b> SBP-137WM1</p>	<p><b>Wall Mount Base</b> SBP-300B</p>	<p><b>Pole Mount</b> SBP-300PM1</p>	<p><b>Corner Mount</b> SBP-300KM1</p>	<p><b>Parapet Mount</b> SBP-300LM</p>
				
<p><b>Weather Cap</b> SBV-120WC</p>	<p><b>Smoke Dome Cover</b> SPB-VAN12</p>			

QNV - 6010R / 6020R / 6030R / 7010R / 7020R / 7030R (ivory)



Ceiling Mount



SBP-300CMW

Hanging Mount



SBP-122HM



Weather Cap



SBV-120WC

Wall Mount



SBP-137WM1

QNV - 6010R / 6020R / 6030R / 7010R / 7020R / 7030R (ivory)



Wall Mount

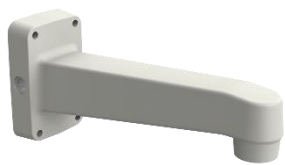

SBP-390WM2

or

Option



Wall Mount Base  
SBP-300B

+



SBP-300WM1

or



SBP-300WM

+

Hanging Mount



SBP-122HM

QNV - 6010R / 6020R / 6030R / 7010R / 7020R / 7030R (ivory)



Pole Mount



SBP-300PM1



Wall Mount

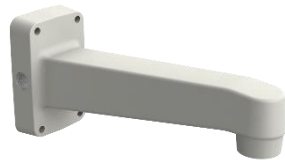

SBP-390WM2

or



SBP-300WM1

or



SBP-300WM



Hanging Mount



SBP-122HM

QNV - 6010R / 6020R / 6030R / 7010R / 7020R / 7030R (ivory)

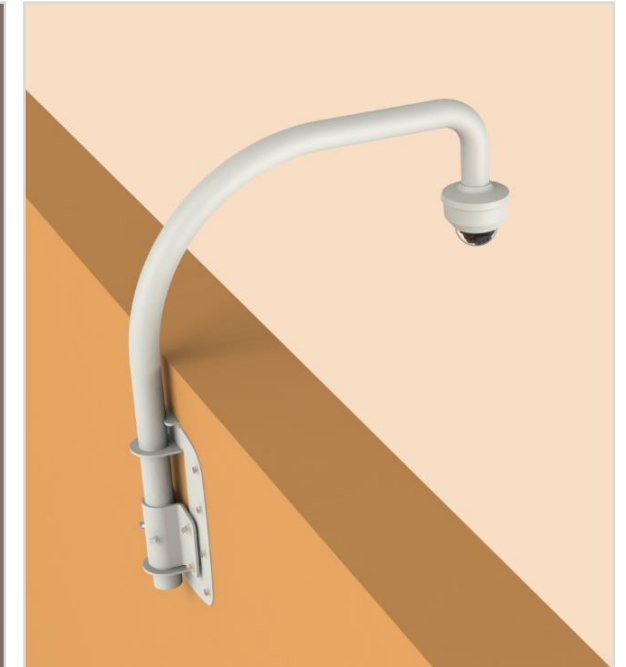

Corner Mount



SBP-300KM1



Wall Mount

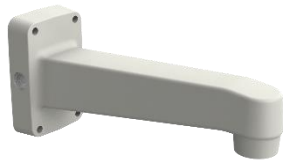

SBP-390WM2

or



SBP-300WM1

or



SBP-300WM



Hanging Mount



SBP-122HM



Parapet Mount



SBP-300LM

Hanging Mount



SBP-122HM

Ø109mm (4.29") / 2 holes

QNE-8011R



Ø125.0x87.4mm(Ø4.92x3.44")  
645g(1.42 lb)

QNE-8021R



Ø125.0x87.4mm(Ø4.92x3.44")  
645g(1.42 lb)

Camera spec.

**Full Lineup of Acc.**

Ceiling











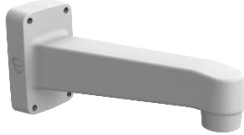

Wall1 / Wall2

Pole

Corner

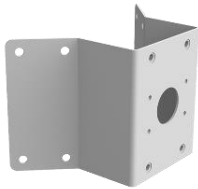
Parapet

QNE - 8011R / 8021R

				
<p><b>Hanging Mount</b> SBP-125HMW</p>	<p><b>Ceiling Mount</b> SBP-300CMW</p>	<p><b>Wall Mount</b> SBP-300WMW1</p>	<p><b>Wall Mount</b> SBP-300WMW</p>	<p><b>Wall Mount</b> SBP-390WMW2</p>
				
<p><b>Wall Mount</b> SBP-125WMW</p>	<p><b>Wall Mount Base</b> SBP-300BW</p>	<p><b>Pole Mount</b> SBP-300PMW1</p>	<p><b>Corner Mount</b> SBP-300KMW1</p>	<p><b>Parapet Mount</b> SBP-300LMW</p>
				
<p><b>Installation Box</b> SBP-300NBW</p>	<p><b>Back Box</b> SBV-125BW</p>			



QNE - 8011R / 8021R



Back Box



SBV-125BW



Ceiling Mount



SBP-300CMW

Hanging Mount



SBP-125HMW

QNE - 8011R / 8021R



Back Box



SBV-125BW



Wall Mount

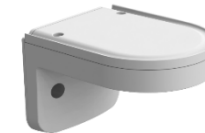

SBP-125WMW

QNE - 8011R / 8021R

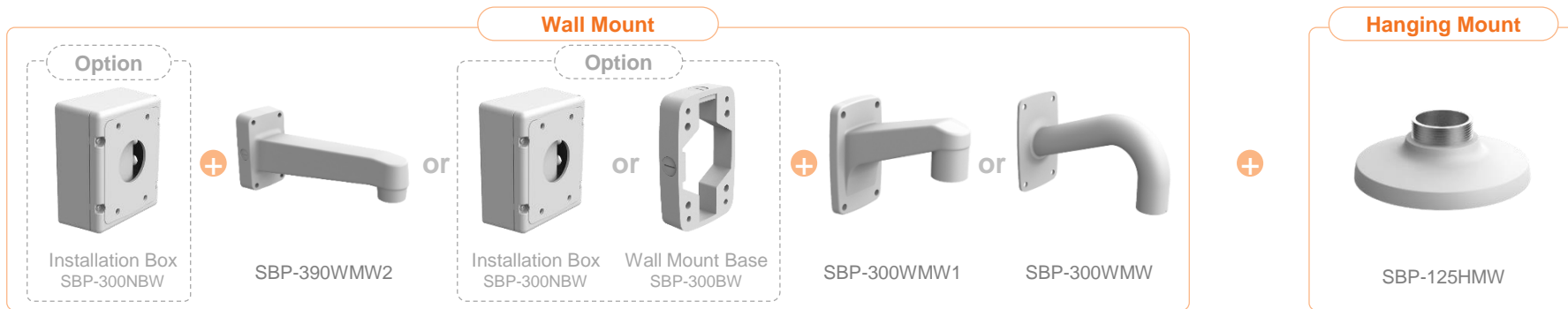

QNE - 8011R / 8021R



Pole Mount



SBP-300PMW1



Option



Installation Box  
SBP-300NBW



SBP-390MMW2

or



SBP-300MMW1

or



SBP-300MMW



SBP-125HMW

QNE - 8011R / 8021R

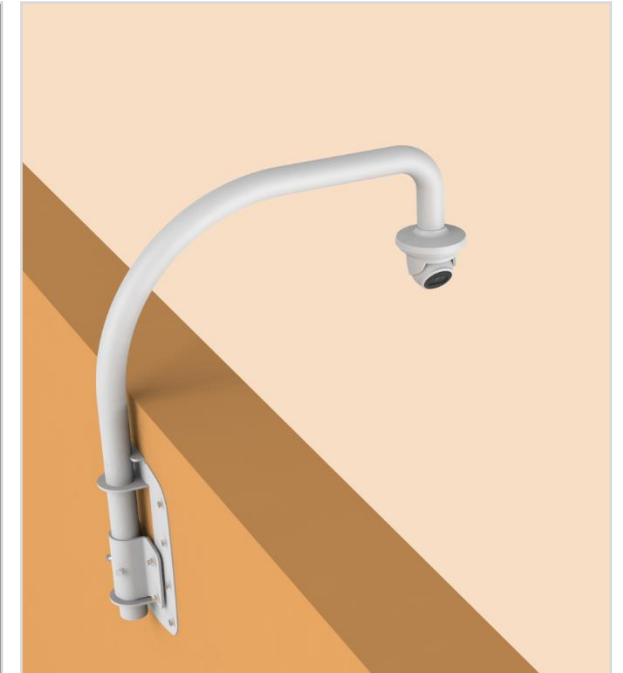

**Corner Mount**

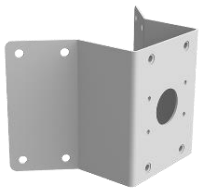

SBP-300KMW1



Option



Installation Box  
SBP-300NBW



**Wall Mount**



SBP-390WMW2

or



SBP-300MMW1

or



SBP-300MMW



**Hanging Mount**



SBP-125HMW



**Parapet Mount**



SBP-300LMW

**Hanging Mount**



SBP-125HMW

Ø127.8mm (5.03") / 3 holes

QNE-6080RVW



Ø144.9x135.5mm(Ø5.7x5.33")  
1.3Kg(2.87lb)

QNE-7080RVW



Ø144.9x135.5mm(Ø5.7x5.33")  
1.3Kg(2.87lb)

Camera spec.

**Full Lineup of Acc.**

Ceiling







Wall

Pole

Corner

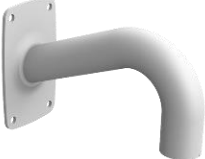
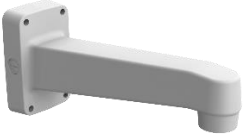
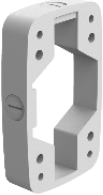
Parapet

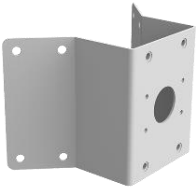
QNE - 6080RVW / 7080RVW

				
<p><b>Hanging Mount</b> SBP-300HMW5</p>	<p><b>Ceiling Mount</b> SBP-300CMW</p>	<p><b>Wall Mount</b> SBP-300WMW1</p>	<p><b>Wall Mount</b> SBP-300WMW</p>	<p><b>Wall Mount</b> SBP-390WMW2</p>
				
<p><b>Wall Mount Base</b> SBP-300BW</p>	<p><b>Pole Mount</b> SBP-300PMW1</p>	<p><b>Corner Mount</b> SBP-300KMW1</p>	<p><b>Parapet Mount</b> SBP-300LMW</p>	<p><b>Installation Box</b> SBP-300NBW</p>

Camera spec.

Full Lineup of Acc.

**Ceiling**

Wall

Pole

Corner

Parapet

QNE - 6080RVW / 7080RVW



**Ceiling Mount**



SBP-300LMW



**Hanging Mount**



SBP-300HMMW5

**Wall Mount**

Option



Installation Box  
SBP-300NBW

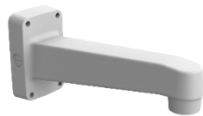

SBP-390MMW2

or

Option



Installation Box  
SBP-300NBW



Wall Mount Base  
SBP-300BW



SBP-300MMW1



SBP-300MMW



**Hanging Mount**



SBP-300HMMW5



QNE - 6080RVW / 7080RVW



**Pole Mount**



SBP-300PMW1



**Option**



Installation Box  
SBP-300NBW



**Wall Mount**



SBP-390MMW2

or



SBP-300MMW1

or



SBP-300MMW



**Hanging Mount**



SBP-300HMW5

QNE - 6080RVW / 7080RVW

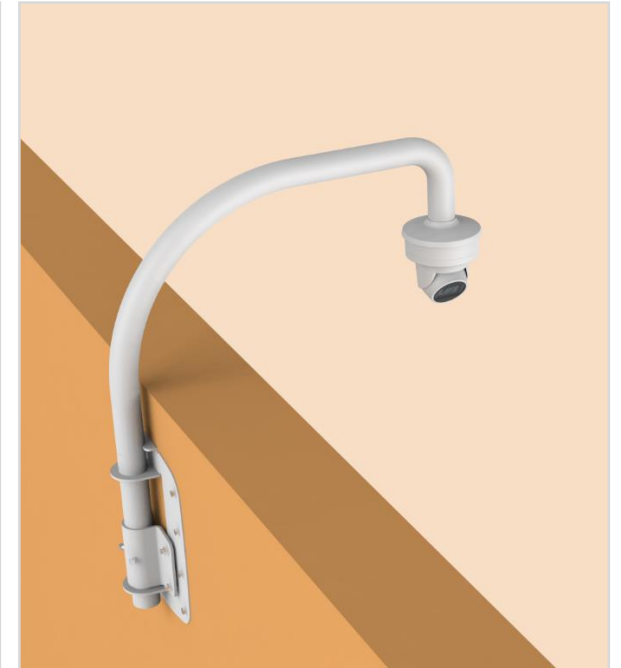

**Corner Mount**

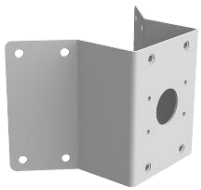

SBP-300KMW1



Option



Installation Box  
SBP-300NBW



**Wall Mount**



SBP-390WMW2

or



SBP-300WMW1

or



SBP-300WMW



**Hanging Mount**



SBP-300HMW5



**Parapet Mount**



SBP-300LMW

**Hanging Mount**



SBP-300HMW5

Ø127.8mm (5.03") / 3 holes

QNE-6080RV



Ø144.9x135.5mm(Ø5.7x5.33")  
1.3Kg(2.87lb)

QNE-7080RV



Ø144.9x135.5mm(Ø5.7x5.33")  
1.3Kg(2.87lb)

Camera spec.

**Full Lineup of Acc.**

Ceiling







Wall

Pole

Corner

Parapet

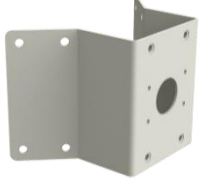
QNE - 6080RV / 7080RV (ivory)

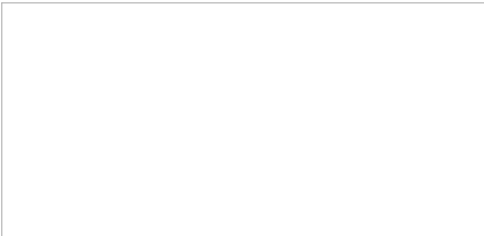
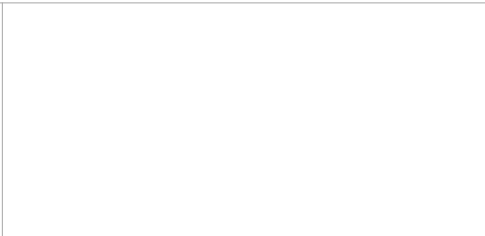
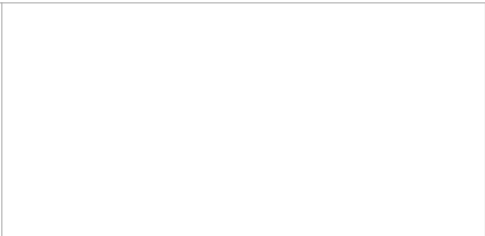
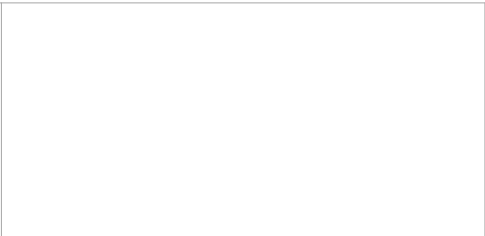
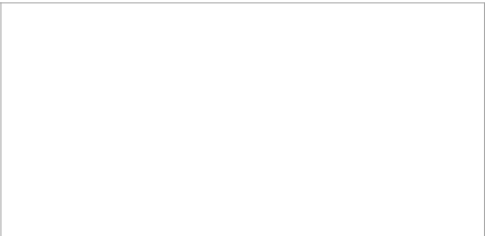
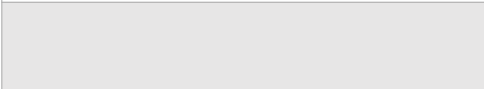
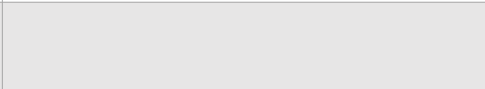
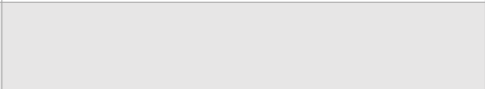
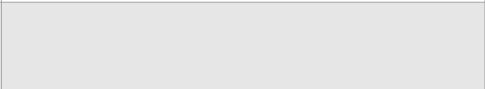
				
<p><b>Hanging Mount</b> SBP-300HM5</p>	<p><b>Ceiling Mount</b> SBP-300CM</p>	<p><b>Wall Mount</b> SBP-300WM1</p>	<p><b>Wall Mount</b> SBP-300WM</p>	<p><b>Wall Mount</b> SBP-390WM2</p>
				
<p><b>Wall Mount Base</b> SBP-300B</p>	<p><b>Pole Mount</b> SBP-300PM1</p>	<p><b>Corner Mount</b> SBP-300KM1</p>	<p><b>Parapet Mount</b> SBP-300LM</p>	<p><b>Back Box</b> SBF-100B1</p>
				
				

QNE - 6080RV / 7080RV (ivory)



Back Box



SBP-100B1



Ceiling Mount



SBP-300CMW

Hanging Mount



SBP-300HM5

QNE - 6080RV / 7080RV (ivory)



Back Box



SBP-100B1

Wall Mount

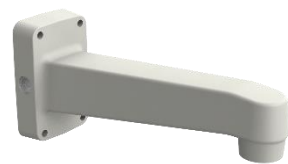

SBP-390WM2

Option

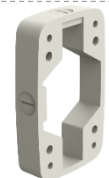

Wall Mount Base  
SBP-300B



SBP-300WM1



SBP-300WM

Hanging Mount



SBP-300HM5

QNE - 6080RV / 7080RV (ivory)



Pole Mount



SBP-300PM1



Wall Mount

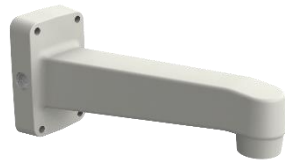

SBP-390WM2

or



SBP-300WM1

or



SBP-300WM



Hanging Mount



SBP-300HM5

QNE - 6080RV / 7080RV (ivory)

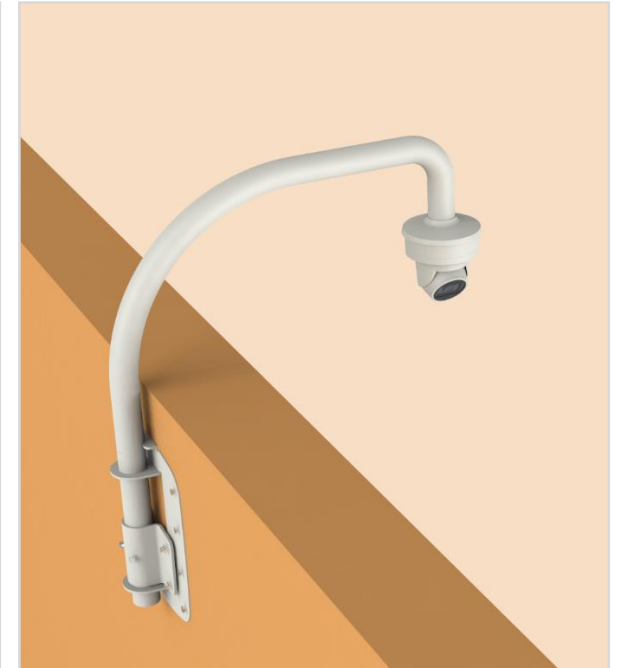

Corner Mount



SBP-300KM1



Wall Mount

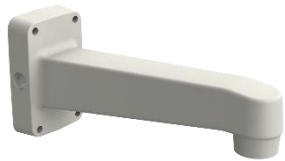

SBP-390WM2

or



SBP-300WM1

or



SBP-300WM



Hanging Mount



SBP-300HM5

Parapet Mount



SBP-300LM



Hanging Mount



SBP-300HM5



Ø73mm (2.87") / 3 Shafts

QNP-6250H



Ø204 x 265mm(8.04 x 10.43")  
2.7kg(5.95lb)

QNP-6320H



Ø204 x 265mm(8.04 x 10.43")  
2.7kg(5.95lb)

Camera spec.

**Full Lineup of Acc.**

Ceiling













Wall

Pole

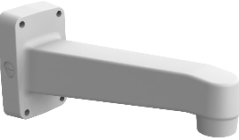
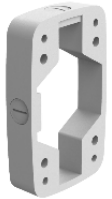
Corner

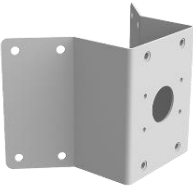
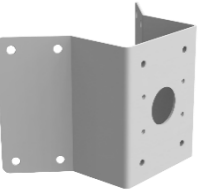
Parapet

QNP – 6250H / 6320H

				
<b>Hanging Mount</b> SBP-156HMMW	<b>Ceiling Mount</b> SBP-156CMW	<b>Ceiling Mount</b> SBP-300CMW	<b>Wall Mount</b> SBP-156WMW	<b>Wall Mount</b> SBP-300WMW1
				
<b>Wall Mount</b> SBP-300WMW	<b>Wall Mount</b> SBP-390WMW2	<b>Wall Mount Base</b> SBP-300BW	<b>Pole Mount</b> SBP-300PMW1	<b>Corner Mount</b> SBP-300KMW1
				
<b>Corner Mount</b> SBP-156KMW	<b>Parapet Mount</b> SBP-300LMW	<b>Parapet Mount</b> SBP-156LMW	<b>Installation Box</b> SBP-300NBW	<b>I/O Box</b> SPM-4210

QNP - 6250H / 6320H



Ceiling Mount



SBP-300CMW



Hanging Mount



SBP-156HMW



Ceiling Mount



SBV-156CMW

QNP – 6250H / 6320H



Wall Mount



SBP-156WMW

Wall Mount

Option



Installation Box SBP-300NBW



SBP-390WMW2



Installation Box SBP-300NBW

Option

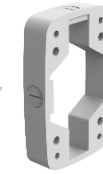

Wall Mount Base SBP-300BW



SBP-300WMW1



SBP-300WMW



Hanging Mount



SBP-156HMW

QNP – 6250H / 6320H



Wall Mount



SBP-156WMW

Pole Mount



SBP-300PMW1

Option



Installation Box  
SBP-300NBW

Wall Mount



SBP-390MMW2

or



SBP-300MMW1

or



SBP-300MMW

Hanging Mount



SBP-156HMW

QNP – 6250H / 6320H



Corner Mount

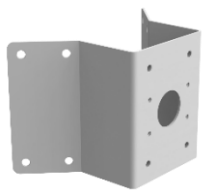

SBP-156KMW



Corner Mount



SBP-156WMW

Corner Mount

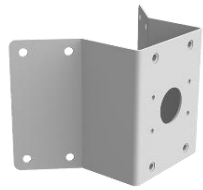

SBP-300KMW1



Option



Installation Box  
SBP-300NBW



Wall Mount



SBP-390WMW2

or



SBP-300WMW1

or



SBP-300WMW



Hanging Mount



SBP-156HMW

QNP – 6250H / 6320H



Parapet Mount



SBV-156LMW



Parapet Mount



SBP-300LMW



Hanging Mount



SBP-156HMW

Ø120.2mm (4.73") / 4 holes

QNP-6250



Ø152x218mm(5.98x8.58")  
1.7Kg(3.75 lb)

QNP-6320



Ø152x218mm(5.98x8.58")  
1.7Kg(3.75 lb)



Camera spec.

**Full Lineup of Acc.**

Ceiling















Wall

Pole

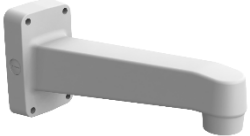
Corner

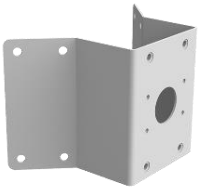
Parapet

QNP – 6250 / 6320

			<b>Plenum</b> 		
<b>Hanging Mount</b> SBP-301HMMW3	<b>Ceiling Mount</b> SBP-300CMW	<b>In-ceiling Housing</b> SHP-1520FW	<b>In-ceiling Housing</b> SHP-1680FPW	<b>In-ceiling Housing</b> SHP-3701F(ivory)	<b>In-ceiling Housing</b> SHP-3701FB(ivory)
					
<b>Wall Mount</b> SBP-300WMW1	<b>Wall Mount</b> SBP-300WMW	<b>Wall Mount</b> SBP-390WMW2	<b>Wall Mount Base</b> SBP-300BW	<b>Pole Mount</b> SBP-300PM1W	<b>Corner Mount</b> SBP-300KMW1
					
<b>Parapet Mount</b> SBP-300LMW	<b>Installation Box</b> SBP-300NBW	<b>Smoke Dome Cover</b> SPB-PTZ6			

QNP – 6250 / 6320



Ceiling Mount



SBP-300CMW



Hanging Mount



SBP-301HMMW3

Plenum



In-ceiling Housing



SHP-3701FB (ivory)

or



SHP-3701F (ivory)

or



SHP-1520FW

or

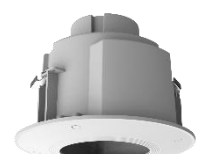

SHP-1680FPW

QNP – 6250 / 6320



Wall Mount

Option



Installation Box  
SBP-300NBW



SBP-390WMW2



Installation Box  
SBP-300NBW

Option

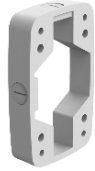

Wall Mount Base  
SBP-300BW



SBP-300WMW1



SBP-300WMW



Hanging Mount



SBP-301HMW3

QNP – 6250 / 6320



Pole Mount



SBP-300PMW1



Option



Installation Box  
SBP-300NBW



Wall Mount



SBP-390MMW2

or



SBP-300MMW1

or



SBP-300MMW



Hanging Mount



SBP-301HMMW3

QNP – 6250 / 6320

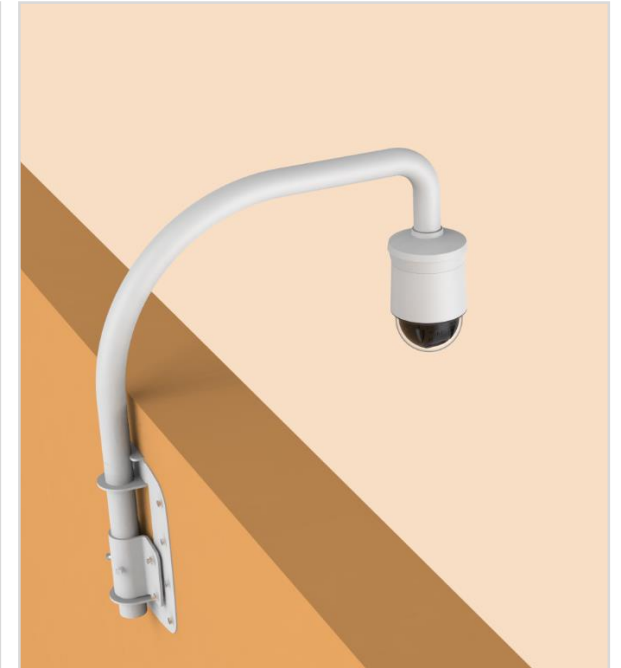

**Corner Mount**



SBP-300KMW1



Option



Installation Box  
SBP-300NBW



**Wall Mount**



SBP-390WMW2

or



SBP-300WMW1

or



SBP-300WMW



**Hanging Mount**



SBP-301HMW3

**Parapet Mount**



SBP-300LMW



**Hanging Mount**



SBP-301HMW3

Ø120.2mm (4.73") / 4 holes

QNP-6230



Ø152x218mm(5.98x8.58")  
1.7Kg(3.75 lb)

Camera spec.

**Full Lineup of Acc.**

Ceiling















Wall

Pole

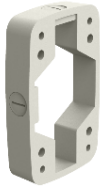
Corner

Parapet

QNP - 6230 (ivory)

			 <b>Plenum</b>		
<b>Hanging Mount</b> SBP-301HM3	<b>Ceiling Mount</b> SBP-300CM	<b>In-ceiling Housing</b> SHP-1520FW	<b>In-ceiling Housing</b> SHP-1680FPW	<b>In-ceiling Housing</b> SHP-3701F	<b>In-ceiling Housing</b> SHP-3701FB
					
<b>Wall Mount</b> SBP-300WM1	<b>Wall Mount</b> SBP-300WM	<b>Wall Mount</b> SBP-390WM2	<b>Wall Mount Base</b> SBP-300B	<b>Pole Mount</b> SBP-300PM1	<b>Corner Mount</b> SBP-300KM1
					
<b>Parapet Mount</b> SBP-300LM	<b>Smoke Dome Cover</b> SPB-PTZ6	<b>Housing</b> SHP-3701H			

QNP - 6230 (ivory)



Hanging Mount



SBP-300CM



Hanging Mount



SBP-301HM3

or

Housing



SHP-3701H



In-ceiling Housing



SHP-3701FB

or



SHP-3701F

or



SHP-1520FW

or



SHP-1680FPW

Plenum



QNP - 6230 (ivory)



Wall Mount

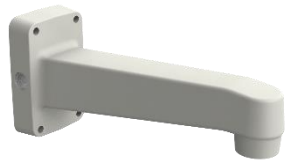

SBP-390WM2

or



Wall Mount Base  
SBP-300B

+



SBP-300WM1

or



SBP-300WM

+

Hanging Mount



SBP-301HM3

or



SHP-3701H

QNP - 6230 (ivory)



Pole Mount



SBP-300PM1



Wall Mount

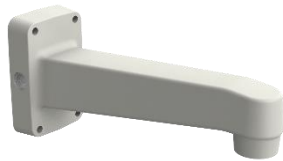

SBP-390WM2

or



SBP-300WM1

or



SBP-300WM



Hanging Mount



SBP-301HM3

or

Housing



SHP-3701H

QNP - 6230 (ivory)



Corner Mount



SBP-300KM1



Wall Mount

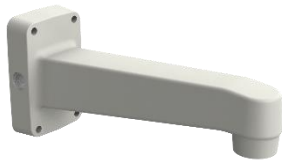

SBP-390WM2

or



SBP-300WM1

or



SBP-300WM



Hanging Mount



SBP-301HM3

or

Housing



SHP-3701H

QNP - 6230 (ivory)



Parapet Mount



SBP-300LM



Hanging Mount



SBP-301HM3

or

Housing



SHP-3701H

## 1-1/2 inch PF TAP

QNP-6230H



Ø220x293.6mm(8.66x11.56")  
3.3Kg(7.28 lb)

QNP-6230RH



Ø236.9x407.7mm(9.33x16.05")  
6.8Kg(14.99 lb)

Camera spec.

**Full Lineup of Acc.**

Ceiling











Wall

Pole

Corner

Parapet

QNP - 6230H / 6230RH (ivory)

				
<p><b>Installation Base</b> SBP-303HF</p>	<p><b>Ceiling Mount</b> SBP-300CM</p>	<p><b>Wall Mount</b> SBP-300WM1</p>	<p><b>Wall Mount</b> SBP-300WM</p>	<p><b>Wall Mount</b> SBP-390WM2</p>
				
<p><b>Wall Mount Base</b> SBP-300B</p>	<p><b>Pole Mount</b> SBP-300PM1</p>	<p><b>Corner Mount</b> SBP-300KM1</p>	<p><b>Parapet Mount</b> SBP-300LM</p>	<p><b>Smoke Dome Cover</b> SPB-PTZ7</p>

Camera spec.

Full Lineup of Acc.

Ceiling

Wall

Pole

Corner

Parapet

QNP - 6230H / 6230RH (ivory)



Ceiling Mount



SBP-156KMW

Option



Installation Base  
SBP-303HF

Wall Mount

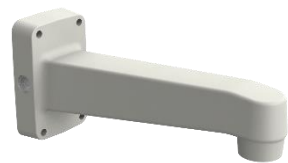

SBP-390WM2

or

Option



Wall Mount Base  
SBP-300B



SBP-300WM1

or



SBP-300WM



Option



Installation Base  
SBP-303HF

QNP - 6230H / 6230RH (ivory)



Pole Mount



SBP-300PM1



Wall Mount

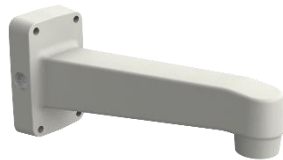

SBP-390WM2

or



SBP-300WM1

or



SBP-300WM



Option



Installation Base  
SBP-303HF



Camera spec.

Full Lineup of Acc.

Ceiling

Wall

Pole

Corner

Parapet

QNP - 6230H / 6230RH (ivory)



Corner Mount



SBP-300KM1



Wall Mount

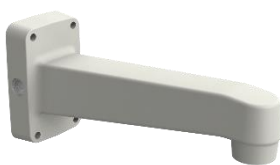

SBP-390WM2

or



SBP-300WM1

or



SBP-300WM



Option



Installation Base  
SBP-303HF

Parapet Mount



SBP-300LM



Option



Installation Base  
SBP-303HF

### 1/4"-20 UNC TAP / 2 holes

QNB-6002



73.8(W)x66.6(H)x136.2(D)mm(2.9x2.6x5.4")  
320g(0.71 lb)

QNB-8002







73.8(W)x66.6(H)x136.2(D)mm(2.9x2.6x5.4")  
320g(0.71 lb)

Camera spec.

Full Lineup of Acc.

QNB - 6002 / 8002

				
<b>Wall Mount</b> STB-4150V	<b>Housing</b> SHB-4300H1	<b>Housing</b> SHB-4200	<b>Housing</b> SHB-4200H	

**Camera spec.**

Full Lineup of Acc.

Pole

Ø65.5mm (2.58") / 3 holes

QNO-6010R	QNO-6012R1	QNO-6020R	QNO-6022R1	QNO-6030R	QNO-6032R1	QNO-6070R	QNO-6072R1	QNO-6082R	QNO-6082R1	QNO-7010R
										
Ø70.0x246.0mm (Ø2.76x9.69") 730g (1.61 lb)	Ø70.0x246.0mm (Ø2.76x9.69") 700g(1.54 lb)	Ø70.0x246.0mm (Ø2.76x9.69") 730g (1.61 lb)	Ø70.0x246.0mm (Ø2.76x9.69") 700g(1.54 lb)	Ø70.0x246.0mm (Ø2.76x9.69") 730g (1.61 lb)	Ø70.0x246.0mm (Ø2.76x9.69") 700g(1.54 lb)	Ø70.0x246.0mm (Ø2.76x9.69") 730g (1.61 lb)	Ø70.0x246.0mm (Ø2.76x9.69") 730g (1.61 lb)	Ø78.0x259.8mm (Ø3.07x10.23") 900g(1.98 lb)	Ø78.0x259.8mm (Ø3.07x10.23") 900g(1.98 lb)	Ø70.0x246.0mm (Ø2.76x9.69") 730g (1.61 lb)

Ø65.5mm (2.58") / 3 holes



QNO-7012R	QNO-7020R	QNO-7022R	QNO-7030R	QNO-7032R	QNO-7080R	QNO-7082R	QNO-8010R	QNO-8020R	QNO-8030R	QNO-8080R
										
Ø70.0 x 246.0mm (Ø2.76 x 9.69") 700g (1.543 lb)	Ø70.0x246.0mm (Ø2.76x9.69") 730g (1.61 lb)	Ø70.0 x 246.0mm (Ø2.76 x 9.69") 700g (1.543 lb)	Ø70.0x246.0mm (Ø2.76x9.69") 730g (1.61 lb)	Ø70.0 x 246.0mm (Ø2.76 x 9.69") 700g (1.543 lb)	Ø70.0x246.0mm (Ø2.76x9.69") 750g(1.65 lb)	Ø78.0 x 259.8mm (Ø3.07 x 10.23") 900g (1.984 lb)	Ø70.0x246.0mm (Ø4.33x3.39") 680g(1.50 lb)	Ø70.0x246.0mm (Ø4.33x3.39") 680g(1.50 lb)	Ø70.0x246.0mm (Ø4.33x3.39") 680g(1.50 lb)	Ø91x322.9mm (Ø35.8x127.1") 1190g(2.62 lb)

Camera spec.

**Full Lineup of Acc.**

Pole

QNO - 6010R / 6012R1 / 6020R / 6022R1 / 6030R / 6032R1 / 6070R / 6072R1 / 6082R / 6082R1 / 7010R / 7012R / 7020R / 7022R / 7030R / 7032R / 7080R / 7082R / 8010R / 8020R / 8030R / 8080R

				
<p><b>Back Box</b> SBO-126B(QNO-8080R)</p>	<p><b>Back Box</b> SBO-100B1</p>	<p><b>Pole Mount</b> SBP-302PM</p>		

Camera spec.

Full Lineup of Acc.

**Pole**

QNO - 6010R / 6012R1 / 6020R / 6022R1 / 6030R / 6032R1 / 6070R / 6072R1 / 6082R / 6082R1 / 7010R / 7012R / 7020R / 7022R / 7030R / 7032R / 7080R / 7082R / 8010R / 8020R / 8030R / 8080R

QNO - 6010R / 6012R1 / 6020R / 6022R1 / 6030R / 6032R1 / 6070R / 6072R1 / 6082R / 6082R1 / 7010R / 7012R / 7020R / 7022R / 7030R / 7032R / 7080R / 7082R / 8010R / 8020R / 8030R

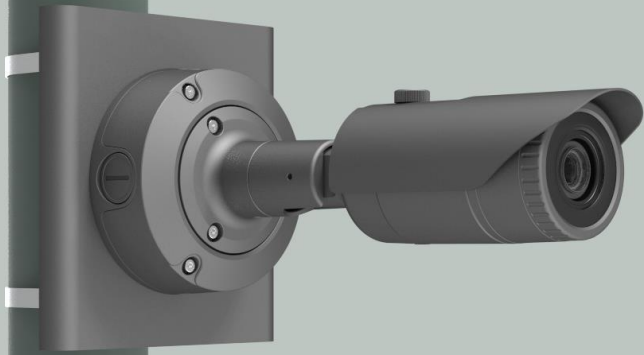

QNO-8080R

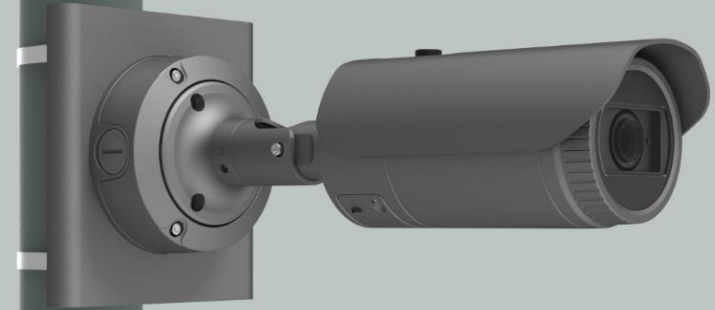

Pole Mount



SBP-302PM

Back Box



SBO-100B1



Pole Mount



SBP-302PM

Back Box



SBO-126B



Thank you !